



BETAtherm® · BETAflam®
High-quality industrial cables

75
Years
LEONI Studer AG
1939 – 2014

The Quality Connection

LEONI



High-quality industrial cables

The safety and availability of technical installations become more and more important in the future. In addition the prevention of fires, respectively provisions of adequate protection against the consequences of fires are increasingly required by law.

The basic protection against the impact of combustion gases is to impede emission of toxic and acid forming gases as well as the reduction of combustion gas emission overall. Therefore all cable insulations should be free of halogens and flame-retardant.

A major contribution to the prevention of fire in electrical installations represent the cross-linked insulation materials, which make cables highly flame retardant, even in case of short circuit.

Our BETAflam® cable family and our BETAtherm® cables are designed according to these requirements.

Issue: January 2014 © LEONI Studer AG

The contents of this brochure are protected by copyright. All rights reserved.

We reserve the right to make technical modifications, typographical errors and mistakes. The current issue of the catalogue is available at www.leoni-studer.ch

Safety instructions

Cables are to be used for the designated applications only. In case of failure or damage to the cable or connector, switch off power immediately and replace all damaged parts. Maintenance, repair and replacement of the cables and connectors may only be carried out by authorised and trained personnel.

Waiver

The specifications in this document are provided according to our best current knowledge. However, these specifications may not be considered an assurance of specific properties or suitability for specific purposes of the respective products. Such indications may not be interpreted as a misguidance for the violation of property rights or as an assurance of a corresponding license. The suitability of each product for any particular purpose must be checked beforehand with our specialists. Our policy is to continuously improve our materials and products. Therefore, we reserve the right to offer alternatives consistent with our manufacturing programme at the time of enquiry. All information concerning material properties, fire performance, construction, electrical and technical data, prices etc. reflects our current level of knowledge and is provided without obligation. Dimensions and weights are guideline values. All specifications can be changed at any time without prior notification.

General conditions of sale and delivery

We refer to the currently valid General conditions of sale and delivery which can be obtained from the respective companies.



	Page
The LEONI Group	4
High-quality industrial cables and conductors	5
Great products, great service	6
Green Technology	7
Technologies – investments in sustainable safety	8
Our product portfolio	10

Single cores	12
Safety cables at a glance	14
With increased environmental compatibility	16
With increased temperature resistance	26
With increased dielectric strength	29

Multi-core cables	32
Safety cables at a glance	34
With increased environmental compatibility	36
Shielded cable with increased environmental compatibility	50
Shielded connection cables for motors	60
For rough ambient conditions	64
For flexible heavy current connections	66

Technical information	68
Dimensions and weights	70
Core identification acc. to HD 308 S2	70
Current rating 120 °C	71
Current rating 90 °C	72
Ambient conditions	74
Electron-beam cross-linking	75
Chemical resistance	76
Halogen-free	77
Corrosive effects of combustion gases	77
Smoke density	78
Flame retardant	78
No flame propagation	79
Insulation integrity under fire	79
Insulation integrity with mechanical shock	80
System integrity	80
Duration of system insulation integrity in the building	81
Further products	82

The LEONI Group

Cable expertise for the most various industrial markets



LEONI is a leading supplier of cable systems and related services for the automotive industry and various other industrial sectors.

Our group of companies employs more than 61,000 people in 32 countries. Corporate vision, highest quality and innovative power have made us one of the leading cable manufacturers in Europe. LEONI develops and produces technically sophisticated products ranging from wire and optical fibers to cables through to complete cable systems and also offers the related services. Moreover, the product portfolio comprises strands, standardised cables, hybrid cables, glass fiber as well as special cables, cable harnesses, wiring systems components and fully assembled systems for applications in various industrial markets.

Your markets – our strength.

As diverse as our product and service range are the markets and sectors LEONI is supplying. We focus our activities on customers in the fields of Automotive & Commercial Vehicles, Industry & Healthcare, Communication & Infrastructure, Electrical Appliances and Conductors & Copper Solutions.

We are among the leading European suppliers in the Communication & Infrastructure market to which at LEONI as a cable manufacturer also belong activities in the fields of infrastructure & data communications, industrial plant projects, solar- and wind power, energy & telecommunications, irradiation cross-linking and traffic engineering. Our customers benefit worldwide from innovative as well as reliable and long-lasting products of high quality.

LEONI – we create the best connection for your future.

For further information, visit www.leoni.com

Products and services portfolio at a glance

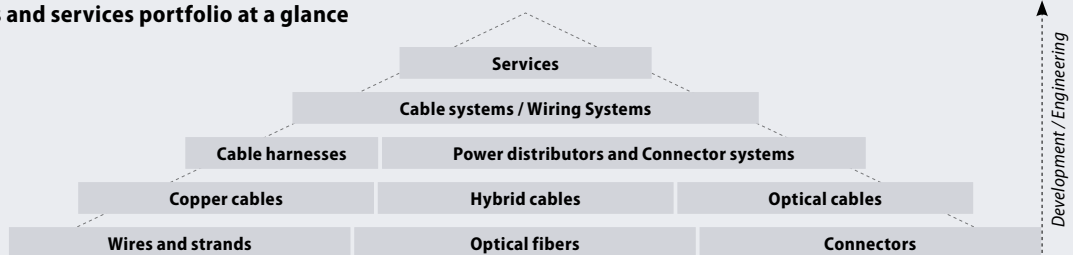

LEONI's core markets



High-quality industrial cables and conductors



Business Unit Traffic

High-quality industrial cables and conductors

We are an internationally-recognised manufacturer of high-quality cables and conductors for a wide variety of applications and functions in various sectors of industry, often involving extreme ambient conditions. Our diverse range of products includes cables with an increased resistance to external influences, and conductors with a maximum level of temperature resistance and extra electrical strength. We develop and produce high quality products, and make use of extremely sophisticated compounds to insulate and sheath the cables.

Your partner for competent solutions

In our modern laboratories we develop reliable compounds and cables. Through continuous investments into our production lines, they are held on a high technical standard. Furthermore our outstanding competence in the cabling business is expressed by the progressive cross-linking centre of the company. We also have an in-house fire testing laboratory for testing our products. A multitude of national and international certificates provide proof of our innovation strength.

Quality

During each work step, we assure the quality of production regarding the quality, the reliability and the fulfilment of the functional specifications by means of self test and process control with innovative technology and the consequent use of all quality-system elements.

For further information, visit www.leoni-traffic.com

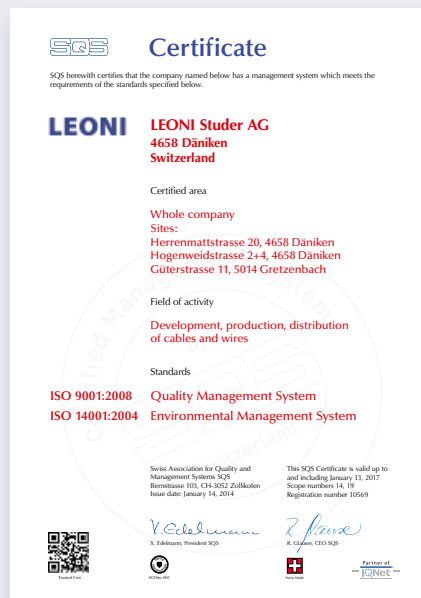

Great products, great services

Put your trust in the best partner to suit your needs



Personal protection



Availability of installation



Environmental responsibility

Our commitment to develop innovative products proves our dedication to our responsibility. In conjunction with our consulting services, we create trust and help our partners accomplish maximum safety and availability of technical systems in their projects.

The safety and availability of technical installations become more and more important in the future. In addition the prevention of fires, respectively provisions of adequate protection against the consequences of fires are evermore frequently requested by law. The basic protection against the impact of combustion gases is to impede emission of toxic and acid forming gases as well as the reduction of combustion gas emission overall. Therefore all cable insulations should be free of halogens and flame retardant. A major contribution to the prevention of fire in electrical installations represent the cross-linked insulation materials, which make cables very hard inflammable even in case of short circuit. Our BETAflam® cable family and our BETAtherm® single cores are designed according to these requirements.

Green Technology

Our company aim is to combine innovation with sustainability. It is one of our central company goals.



The growing scarcity of the natural resources and the increasing burden on the environment necessitate a reassessment. Demands have been made on industry to develop processes, products and applications which are sustainable, energy-saving and environmentally compatible. LEONI combines its efforts, to both improve the value added chain in consideration of environmental aspects and to provide products specifically for use with proven environmental technologies, under the concept of "Green Technology".

In the process, we assess our activities according to three criteria:

Product: We strive to continuously increase the share of environmentally compatible raw materials that are low in pollutants in our cable products and to continuously increase the recyclability of the processed materials and components.

Process: We constantly work at optimising the efficiency with which resources are used in the manufacturing process by deploying energy-efficient machines or taking heat recovery measures. More and more locations in our global production network are environmentally certified according to the ISO 14001 standard.

Application: We offer increasing numbers of products and solutions which are used directly in specifically defined markets and applications or serve as preliminary products or components for green end applications, such as in the solar industry or railway technology.

New environmental regulations have been in force in the European Union since July 2006.

EU directive 2002/96/EG WEEE
(Waste Electrical and Electronic Equipment) regulates the disposal of electrical and electronic equipment and components.

EU directive 2011/65/EG RoHS
(Restriction of the Use of certain Hazardous Substances in electrical and electronic Equipment) restricts the use of certain hazardous substances in electrical and electronic equipment and components.



This means avoiding the following substances, among others:

- Polybrominated diphenyl ether (PBDE)
- Decabromodiphenyl ether (DecaBDE)
- Perfluorooctane sulfonate (PFOS)
- Pentabromodiphenyl ether (PentaBDE)
- Octabromodiphenyl ether (OctaBDE)
- Lead (Pb)
- Mercury (Hg)
- Cadmium (Cd)
- Hexavalent chromium (Cr VI)
- Polybrominated biphenyls (PBB)

Technologies – investments in sustainable safety

Universal use with extremely high functional integrity



Our development and production centres LEONI Studer (Switzerland) and LEONI Kerpen (Germany) are linked by one thing in particular: competence. In extensive production areas, we work with state-of-the-art methods and systems in plastics processing, materials processing, extrusion technology, electron beam cross-linking and the testing of all products.

We use state-of-the-art production equipment in order to offer our customers a maximum of safety and quality. New and innovative plastics mixtures and cables are constantly being developed in modern laboratories. The focus is on improved insulating properties, higher temperature tolerances, longer lifetimes, easy handling and better safety features. Our test laboratories for flammability tests, HF technology and optical measurement technology safeguard our quality standards and promote innovation.

This is demonstrated by the large number of approvals and certificates coming from well-known independent testing institutes worldwide.

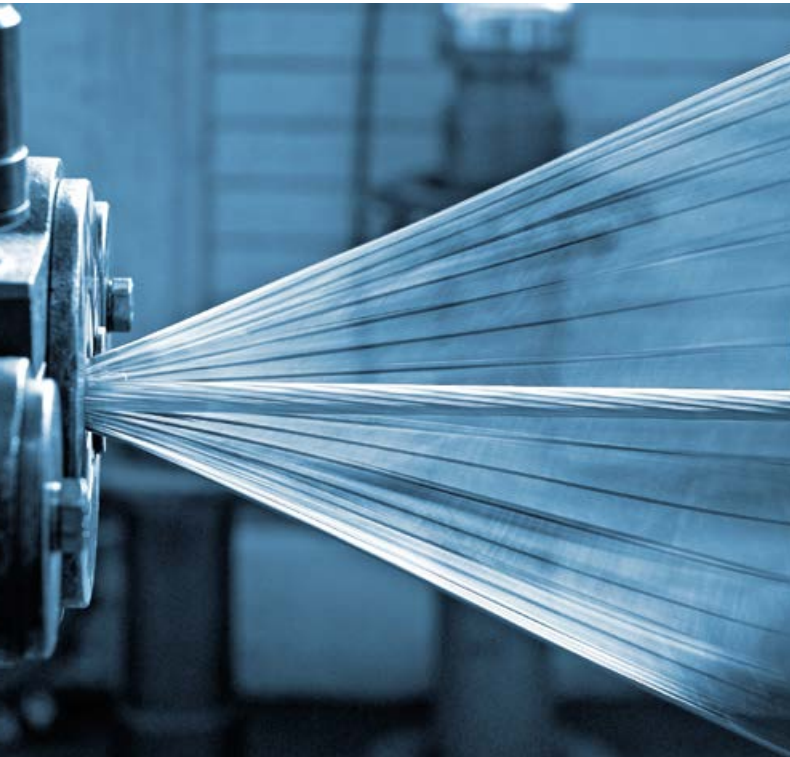

In the fire test laboratory, the fire-resistant properties of our products are tested by certified testers, technicians and engineers. This pool of equipment is used for the very flexible execution of the wide range of measurements required for BS 6387 C.W.Z., IEC 60331-11/21 and DIN 4102 Part 12, as well as customer-specific requirements and special tests.

A multitude of national and international certificates provide proof of the company's powers of innovation.

- **Halogen-free**
IEC 60754-1, EN 50267-2-1
- **Degree of acidity of combustion gases**
IEC 60754-2, EN 50267-2-2
- **Smoke density**
IEC 61034, EN 61034
- **Flame retardant**
IEC 60332-1, EN 60332-1, VDE 0482-332-1
- **Insulation integrity**
BS 6387 C.W.Z., DIN VDE 0472-814, EN 50200, EN 50362, IEC 60331-11/21, VdS 3423, VDE 0482-200
- **System integrity under fire**
DIN 4102 part 12
- **Non-flame propagating**
IEC 60332-3, EN 60332-3, VDE 0482-332-3 series
- **IT cabling systems for offices**
EN 50173-2, ISO/IEC 11801
- **IT cabling system Industry**
EN 50173-3, ISO/IEC 24702
- **IT cabling system Data Center**
EN 50173-5, ISO/IEC 24764



Numerous national and international certificates confirm the company's ability to provide innovative solutions.



Our product portfolio

Overview

Page		16	18	20	21	23	23	25	26	27	29	30	31	36
		BETAtherm® 90	BETAtherm® 110	BETAtrans® GKW R	BETAtherm® 145	BETAtherm® 145 UL 3266	BETAtherm® 145 UL 3271	BETAtherm® 145 UL 3820	BETAtherm® 155	BETAtherm® 155 UL 3289	BETAtherm® 120 1.8/3 kV	BETAtrans® 4 GKW-AX plus	BETAtrans® 9 GKW-AX plus	BETAflam® INSTAflex
Halogen free	IEC 60754-1	<input type="checkbox"/>	<input type="checkbox"/>	<input type="checkbox"/>	<input type="checkbox"/>	<input type="checkbox"/>	<input type="checkbox"/>	<input type="checkbox"/>			<input type="checkbox"/>	<input type="checkbox"/>	<input type="checkbox"/>	<input type="checkbox"/>
Corrosive effects of combustion gases	IEC 60754-2	<input type="checkbox"/>	<input type="checkbox"/>	<input type="checkbox"/>	<input type="checkbox"/>	<input type="checkbox"/>	<input type="checkbox"/>	<input type="checkbox"/>			<input type="checkbox"/>	<input type="checkbox"/>	<input type="checkbox"/>	<input type="checkbox"/>
No toxic gases	NF X 70-100	<input type="checkbox"/>	<input type="checkbox"/>	<input type="checkbox"/>	<input type="checkbox"/>	<input type="checkbox"/>	<input type="checkbox"/>	<input type="checkbox"/>			<input type="checkbox"/>	<input type="checkbox"/>	<input type="checkbox"/>	<input type="checkbox"/>
Low smoke density	IEC 61034 (EN 50268-2) ¹	<input type="checkbox"/>	<input type="checkbox"/>	<input type="checkbox"/>	<input type="checkbox"/>	<input type="checkbox"/>	<input type="checkbox"/>	<input type="checkbox"/>	<input type="checkbox"/>	<input type="checkbox"/>	<input type="checkbox"/>	<input type="checkbox"/>	<input type="checkbox"/>	<input type="checkbox"/>
Flame-retardant	IEC 60332-1	<input type="checkbox"/>	<input type="checkbox"/>	<input type="checkbox"/>	<input type="checkbox"/>	<input type="checkbox"/>	<input type="checkbox"/>	<input type="checkbox"/>	<input type="checkbox"/>	<input type="checkbox"/>	<input type="checkbox"/>	<input type="checkbox"/>	<input type="checkbox"/>	<input type="checkbox"/>
No flame propagation	IEC 60332-3 (EN 50266-2) ¹	<input type="checkbox"/>	<input type="checkbox"/>	<input type="checkbox"/>	<input type="checkbox"/>	<input type="checkbox"/>	<input type="checkbox"/>	<input type="checkbox"/>			<input type="checkbox"/>	<input type="checkbox"/>	<input type="checkbox"/>	<input type="checkbox"/>
Low fire load	DIN 51900	<input type="checkbox"/>	<input type="checkbox"/>	<input type="checkbox"/>	<input type="checkbox"/>	<input type="checkbox"/>	<input type="checkbox"/>	<input type="checkbox"/>			<input type="checkbox"/>	<input type="checkbox"/>	<input type="checkbox"/>	<input type="checkbox"/>
Temperature range	-40 °C to +80 °C													<input type="checkbox"/>
	-40 °C to +90 °C													
	-40 °C to +105 °C	<input type="checkbox"/>												
	-40 °C to +110 °C		<input type="checkbox"/>											
	-40 °C to +120 °C			<input type="checkbox"/>							<input type="checkbox"/>			
	-60 °C to +120 °C											<input type="checkbox"/>	<input type="checkbox"/>	
	-55 °C to +145 °C				<input type="checkbox"/>	<input type="checkbox"/>	<input type="checkbox"/>	<input type="checkbox"/>						
	-45 °C to +155 °C													
Short-circuit temperature	+160 °C	<input type="checkbox"/>												<input type="checkbox"/>
	+280 °C		<input type="checkbox"/>	<input type="checkbox"/>	<input type="checkbox"/>	<input type="checkbox"/>	<input type="checkbox"/>	<input type="checkbox"/>	<input type="checkbox"/>	<input type="checkbox"/>	<input type="checkbox"/>	<input type="checkbox"/>	<input type="checkbox"/>	
Nominal voltage U ₀ /U	300/500 V	<input type="checkbox"/>	<input type="checkbox"/>	<input type="checkbox"/>										<input type="checkbox"/>
	300 V					<input type="checkbox"/>								
	600 V						<input type="checkbox"/>			<input type="checkbox"/>				
	450/750 V ≥ 1.5 mm ²	<input type="checkbox"/>	<input type="checkbox"/>		<input type="checkbox"/>					<input type="checkbox"/>				<input type="checkbox"/>
	600/1000 V* ≥ 1.5 mm ²	<input type="checkbox"/>	<input type="checkbox"/>		<input type="checkbox"/>					<input type="checkbox"/>				<input type="checkbox"/>
	600/1000 V*			<input type="checkbox"/>										
	1000 V							<input type="checkbox"/>						
	1800/3000 V										<input type="checkbox"/>	<input type="checkbox"/>		
3600/6000 V												<input type="checkbox"/>		
Approvals	VDE	<input type="checkbox"/>	<input type="checkbox"/>		<input type="checkbox"/>									
	SEV													<input type="checkbox"/>
	ESTI	<input type="checkbox"/>												<input type="checkbox"/>
	UL	<input type="checkbox"/>				<input type="checkbox"/>	<input type="checkbox"/>			<input type="checkbox"/>				
	cUL _{US}							<input type="checkbox"/>						
	CSA					<input type="checkbox"/>	<input type="checkbox"/>			<input type="checkbox"/>				
	Germanischer Lloyd (GL)				<input type="checkbox"/>									
	Lloyd's Register (LR)				<input type="checkbox"/>									
	BUEREAU VERITAS (BV)				<input type="checkbox"/>									
	DNV				<input type="checkbox"/>									
	CCS				<input type="checkbox"/>									
Gost R	<input type="checkbox"/>	<input type="checkbox"/>	<input type="checkbox"/>	<input type="checkbox"/>					<input type="checkbox"/>	<input type="checkbox"/>	<input type="checkbox"/>	<input type="checkbox"/>		

* With fixed and protected installation

¹ Standard was withdrawn, but is still listed in many specification sheets

	38	40	42	45	48	50	51	53	56	58	60	62	64	66
BETAFIAM® CHEMAflex®	<input type="radio"/>	<input type="radio"/>	<input type="radio"/>	<input type="radio"/>	<input type="radio"/>	<input type="radio"/>	<input type="radio"/>	<input type="radio"/>	<input type="radio"/>	<input type="radio"/>	<input type="radio"/>	<input type="radio"/>	<input type="radio"/>	<input type="radio"/>
BETAFIAM® CHEMAflex® R	<input type="radio"/>	<input type="radio"/>	<input type="radio"/>	<input type="radio"/>	<input type="radio"/>	<input type="radio"/>	<input type="radio"/>	<input type="radio"/>	<input type="radio"/>	<input type="radio"/>	<input type="radio"/>	<input type="radio"/>	<input type="radio"/>	<input type="radio"/>
BETAFIAM® 145 flex	<input type="radio"/>	<input type="radio"/>	<input type="radio"/>	<input type="radio"/>	<input type="radio"/>	<input type="radio"/>	<input type="radio"/>	<input type="radio"/>	<input type="radio"/>	<input type="radio"/>	<input type="radio"/>	<input type="radio"/>	<input type="radio"/>	<input type="radio"/>
BETAFIAM® 145 flex UL 4486	<input type="radio"/>	<input type="radio"/>	<input type="radio"/>	<input type="radio"/>	<input type="radio"/>	<input type="radio"/>	<input type="radio"/>	<input type="radio"/>	<input type="radio"/>	<input type="radio"/>	<input type="radio"/>	<input type="radio"/>	<input type="radio"/>	<input type="radio"/>
BETATrans® GWK flex R	<input type="radio"/>	<input type="radio"/>	<input type="radio"/>	<input type="radio"/>	<input type="radio"/>	<input type="radio"/>	<input type="radio"/>	<input type="radio"/>	<input type="radio"/>	<input type="radio"/>	<input type="radio"/>	<input type="radio"/>	<input type="radio"/>	<input type="radio"/>
BETAFIAM® CHEMA C-flex	<input type="radio"/>	<input type="radio"/>	<input type="radio"/>	<input type="radio"/>	<input type="radio"/>	<input type="radio"/>	<input type="radio"/>	<input type="radio"/>	<input type="radio"/>	<input type="radio"/>	<input type="radio"/>	<input type="radio"/>	<input type="radio"/>	<input type="radio"/>
BETAFIAM® CHEMA C-flex DR	<input type="radio"/>	<input type="radio"/>	<input type="radio"/>	<input type="radio"/>	<input type="radio"/>	<input type="radio"/>	<input type="radio"/>	<input type="radio"/>	<input type="radio"/>	<input type="radio"/>	<input type="radio"/>	<input type="radio"/>	<input type="radio"/>	<input type="radio"/>
BETAFIAM® 145 C-flex	<input type="radio"/>	<input type="radio"/>	<input type="radio"/>	<input type="radio"/>	<input type="radio"/>	<input type="radio"/>	<input type="radio"/>	<input type="radio"/>	<input type="radio"/>	<input type="radio"/>	<input type="radio"/>	<input type="radio"/>	<input type="radio"/>	<input type="radio"/>
BETAFIAM® 145 C-flex UL 4486	<input type="radio"/>	<input type="radio"/>	<input type="radio"/>	<input type="radio"/>	<input type="radio"/>	<input type="radio"/>	<input type="radio"/>	<input type="radio"/>	<input type="radio"/>	<input type="radio"/>	<input type="radio"/>	<input type="radio"/>	<input type="radio"/>	<input type="radio"/>
BETATrans® GWK C-flex R	<input type="radio"/>	<input type="radio"/>	<input type="radio"/>	<input type="radio"/>	<input type="radio"/>	<input type="radio"/>	<input type="radio"/>	<input type="radio"/>	<input type="radio"/>	<input type="radio"/>	<input type="radio"/>	<input type="radio"/>	<input type="radio"/>	<input type="radio"/>
BETADrive® C-flex	<input type="radio"/>	<input type="radio"/>	<input type="radio"/>	<input type="radio"/>	<input type="radio"/>	<input type="radio"/>	<input type="radio"/>	<input type="radio"/>	<input type="radio"/>	<input type="radio"/>	<input type="radio"/>	<input type="radio"/>	<input type="radio"/>	<input type="radio"/>
BETADrive® C-flex FE180	<input type="radio"/>	<input type="radio"/>	<input type="radio"/>	<input type="radio"/>	<input type="radio"/>	<input type="radio"/>	<input type="radio"/>	<input type="radio"/>	<input type="radio"/>	<input type="radio"/>	<input type="radio"/>	<input type="radio"/>	<input type="radio"/>	<input type="radio"/>
ROFLEX®	<input type="radio"/>	<input type="radio"/>	<input type="radio"/>	<input type="radio"/>	<input type="radio"/>	<input type="radio"/>	<input type="radio"/>	<input type="radio"/>	<input type="radio"/>	<input type="radio"/>	<input type="radio"/>	<input type="radio"/>	<input type="radio"/>	<input type="radio"/>
BETAFIAM® TRAFIO-FLEX	<input type="radio"/>	<input type="radio"/>	<input type="radio"/>	<input type="radio"/>	<input type="radio"/>	<input type="radio"/>	<input type="radio"/>	<input type="radio"/>	<input type="radio"/>	<input type="radio"/>	<input type="radio"/>	<input type="radio"/>	<input type="radio"/>	<input type="radio"/>

Single cores

BETAtherm® · BETAtrans®

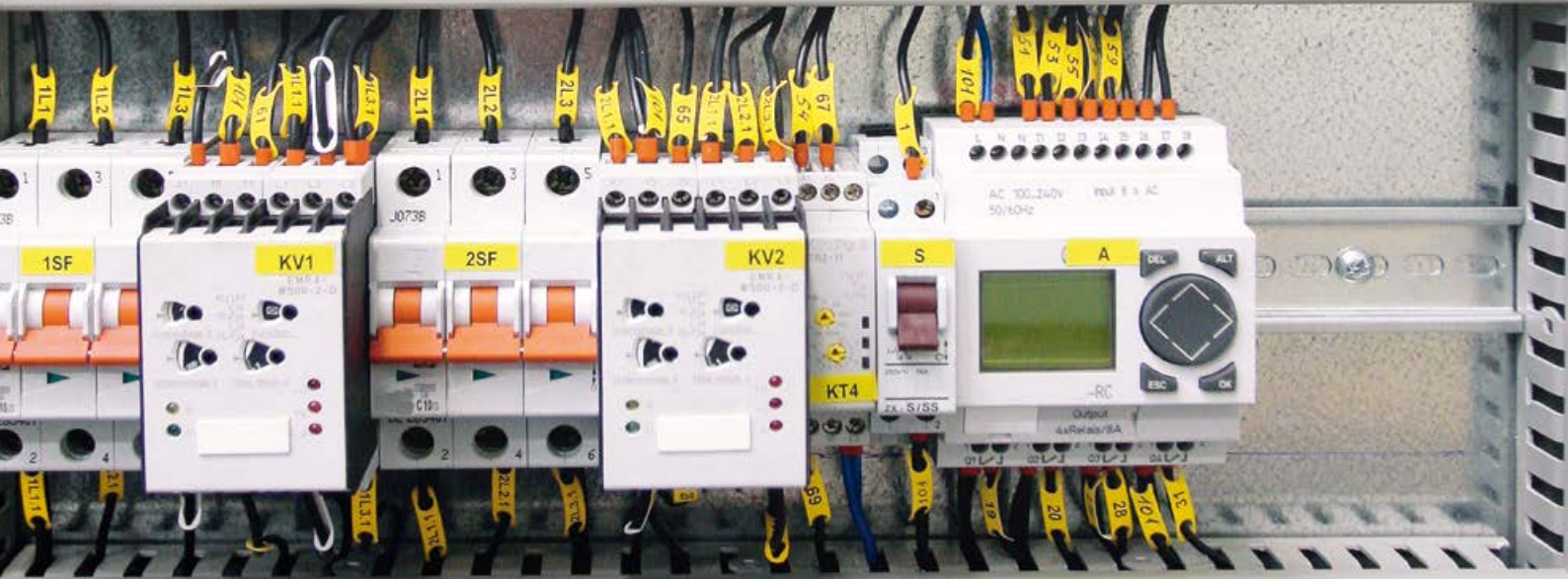
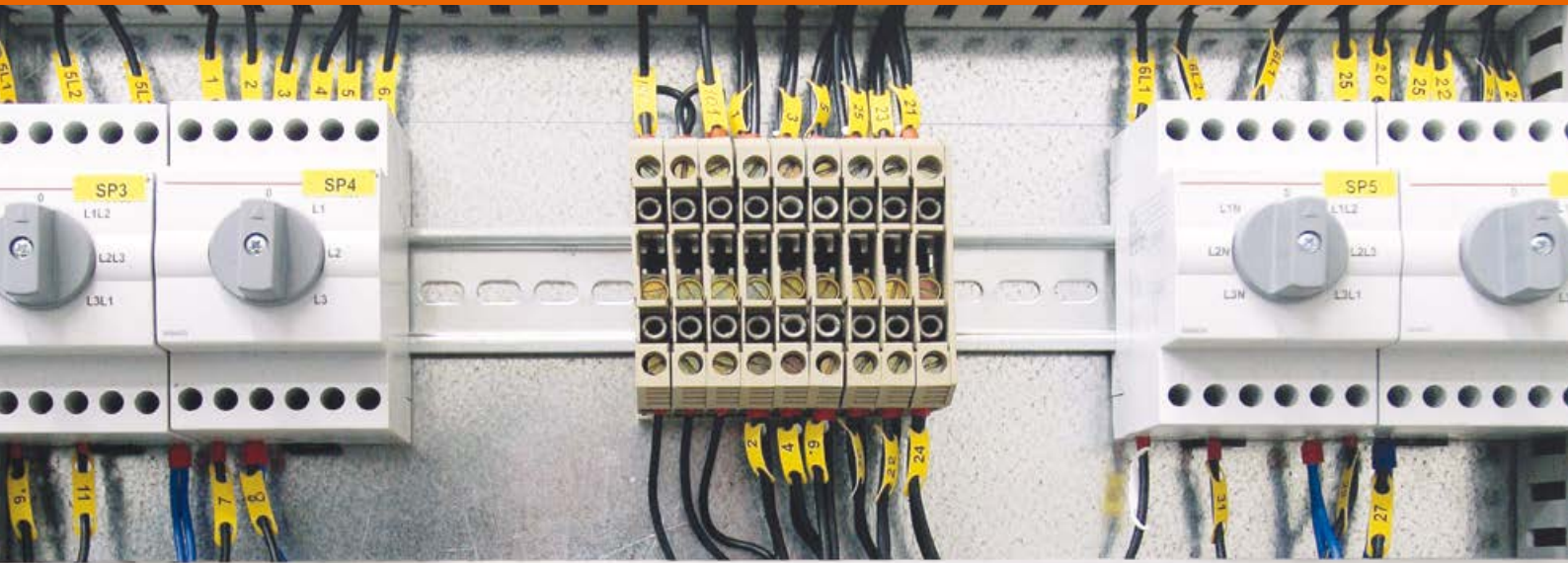







Single cores		Page	
An overview of flexible single cores		14	
	BETAtherm® 90 SO05Z1-K, SO07Z1-K	600 / 1000 V	16
	BETAtherm® 110 H05Z-K, H07Z-K	600 / 1000 V	18
	BETAtrans® GKW R	600 / 1000 V	20
With increased environmental compatibility	BETAtherm® 145 SO07Z-K	600 / 1000 V	21
	BETAtherm® 145 UL / CSA 3266	300 V	23
	UL / CSA 3271	600 V	
	BETAtherm® 145 UL / cUL 3820	1000 V	25
With increased temperature resistance	BETAtherm® 155	600 / 1000 V	26
	BETAtherm® 155 UL / CSA 3289	600 V	27
With increased dielectric strength	BETAtherm® 120 1.8 / 3 kV	1800 / 3000 V	29
	BETAtrans® 4 GKW-AX plus	1800 / 3000 V	30
	BETAtrans® 9 GKW-AX plus	3600 / 6000 V	31

An overview of flexible single cores

BETAtherm®, BETAtrans®



<p>With increased environmental compatibility</p>	<p>BETAtherm® 90 ≤ 1 mm² SO 05Z1-K ≥ 1.5 mm² SO 07Z1-K → page 16</p> 	<p>BETAtherm® 110 ≤ 1 mm² H05Z-K ≥ 1.5 mm² H07Z-K → page 18</p> 
<p>With maximum resistance to temperature</p>	<p>BETAtherm® 155 ≤ 1 mm² 300/500 V ≥ 1.5 mm² 450/750 V → page 26</p> 	<p>BETAtherm® 155 UL/CSA UL 3289/CSA CL 1503/600 V → page 27</p> 
<p>With increased dielectric strength</p>	<p>BETAtherm® 120 1.8/3 kV → page 29</p> 	<p>BETAtrans® 4 GWK-AX plus 1.8/3 kV → page 30</p> 

**BETrans® GKW R**

Volume-optimised
600/1000V
→ page 20

**BETAtherm® 145**

$\leq 1 \text{ mm}^2$ 300/500V
 $\geq 1.5 \text{ mm}^2$ SO 07Z-K
→ page 21

**BETAtherm® 145 UL/CSA**

UL 3266 / CSA AWM I A/B 125°C / 300V
UL 3271 / CSA AWM I A/B 125°C / 600V
→ page 23

**BETAtherm® 145 UL/cUL**

UL 3820 / cUL AWM I A/B 125°C / 1000V
→ page 25

**BETrans® 9 GKW-AX plus**

3.6/6 kV
→ page 31



BETAtherm® 90

Single core with increased environmental compatibility



BETAtherm® 90 ≤ 1 mm² SO 05Z1- K
 BETAtherm® 90 ≥ 1.5 mm² SO 07Z1- K

Competitive advantage

- Best fire performance, halogen free
- VDE permission and ESTI approval

Application

Used for laying in tubes, surface wiring, direct in plaster or underneath it, as well in conduits. May not be laid directly in cable trays, cable racks or cable troughs.

Typical applications are internal wiring in lamps, heating applications, switchboards and distribution boxes in apparatus, mechanical or plant engineering.

Construction

- Conductor Bare fine copper strands acc. to VDE 0295/IEC 60228, class 5
- Insulation Polyolefine copolymer
- Core colour  (further colours upon request)

Electrical properties

Nominal voltage	U ₀ /U ≤ 1 mm ²	300 / 500 V
	U ₀ /U ≥ 1.5 mm ²	450 / 750 V
With fixed and protected installation	U ₀ /U ≥ 1.5 mm ²	600 / 1000 V
Testing voltage		5000 V

Thermal properties

Conductor temperature	fixed installation	+105 °C max.
	occasionally moved	+90 °C max.
Short-circuit temperature		+160 °C max.
Ambient temperature	fixed installation	-40 °C min.
	occasionally moved	-25 °C min.

Bending radius

Fixed installation	> 4 × outer Ø min.
Occasionally moved	> 6 × outer Ø min.

Standards / material properties











- Halogen free: IEC 60754-1, EN 50267-2-1
- No corrosive gases: IEC 60754-2, EN 50267-2-2
- No toxic gases: NF X 70-100
- Low smoke density: IEC 61034, DIN EN 61034-2, EN 50268-2
- Flame retardant: EN/IEC 60332-1-2
- Non-flame propagating: IEC 60332-3, DIN EN 60332-3, EN 50266-2
- Low fire load: DIN 51900

Approvals

- VDE REG no. 6505, certificate no. 107593
- ESTI approval no. 12.0694
- Gost R

Special features

- Special types and UL product range on request
- AWM Style 10551 approval available

Cross-section mm²	Outer Ø mm	Weight kg/km	Fire load kWh/m	Order no. (by Core colour)																
																				
0.25	1.7	5	0.011	∅	∅	∅	∅	∅	∅	∅	∅	∅	∅	∅	∅	∅	∅	∅	∅	∅
0.50	2.2	9	0.017	220521	220522	220523	220524	220525	220526	220921	221349	221351	221548	221350						
0.75	2.4	13	0.020	220527	220528	220529	220530	220531	215667	221560	221556	221544	221549	221553						
1	2.5	15	0.021	220532	220533	220534	220535	220536	220537	220441	221557	221545	221550	220442						
1.5	3.0	21	0.030	220437	216245	220538	220539	220540	220541	220438	221558	221546	221551	221554						
2.5	3.7	33	0.043	220440	220542	220543	220906	220544	220545	221561	∅	221547	221552	∅						
4	4.2	48	0.051	220546	220547	220548	224064	220549	220550	221562	∅	222376	∅	220892						
6	4.8	68	0.060	220551	220552	220553	224065	221315	221316	221563	∅	224066	∅	∅						
10	6.3	112	0.107	220554	220559	221260	224068	221259	221258	221564	∅	224067	∅	220554						
16	7.8	172	0.143	220555	220560	221263	224070	221262	221261	221565	∅	224069	∅	∅						
25	9.2	264	0.185	220556	220561	214150	∅	∅	∅	∅	∅	∅	∅	∅						
35	10.4	355	0.227	220557	220562	221541	∅	∅	∅	∅	∅	∅	∅	∅						
50	12.2	509	0.328	220558	220563	221542	∅	∅	∅	∅	∅	∅	∅	∅						
70	14.2	707	0.454	221540	220564	221543	∅	∅	∅	∅	∅	∅	∅	∅						
95	16.4	921	0.545	222033	220565	∅	∅	∅	∅	∅	∅	∅	∅	∅						
120	18.4	1162	0.621	∅	224891	∅	∅	∅	∅	∅	∅	∅	∅	∅						
150	20.8	1451	0.807	∅	303197	∅	∅	∅	∅	∅	∅	∅	∅	∅						
185	22.9	1723	0.804	∅	303198	∅	∅	∅	∅	∅	∅	∅	∅	∅						
240	25.8	2268	0.991	∅	303200	∅	∅	∅	∅	∅	∅	∅	∅	∅						

BETAtherm® 110

Single core with increased environmental compatibility



BETAtherm® 110 ≤ 1 mm² H05Z - K
BETAtherm® 110 ≥ 1.5 mm² H07Z - K

Application

Used for laying in tubes, surface wiring, direct in plaster or underneath it, as well in conduits. May not be laid directly in cable trays, cable racks or cable troughs.

Typical areas of application include internal wiring of lamps, heating devices, switchboards and distributors in apparatus, machinery and plant construction. When used above 90 °C and up to maximum 110 °C a minor reduction of their service life is to be expected.

Construction

- Conductor Bare fine copper strands acc. to VDE 0295/IEC 60228, class 5
- Insulation Polyolefine copolymer, electron-beam cross-linked
- Core colour  (further colours upon request)

Electrical properties

Nominal voltage	$U_0/U \leq 1 \text{ mm}^2$	300 / 500 V
	$U_0/U \geq 1.5 \text{ mm}^2$	450 / 750 V
With fixed and protected installation	$U_0/U \geq 1.5 \text{ mm}^2$	600 / 1000 V
Testing voltage		5000 V

Competitive advantage

- Very high resistance to temperature
- Service temperature up to +110 °C
- Resistance to cold down to -40 °C
- Best fire performance, halogen free
- Electron-beam cross-linked
- VDE approval H05Z-K / H07Z-K

Thermal properties

Conductor temperature	fixed installation	+110 °C max.
	occasionally moved	+90 °C max.
Short-circuit temperature		+280 °C max.
Ambient temperature	fixed installation	-40 °C min.
	occasionally moved	-25 °C min.

Bending radius

Fixed installation	> 4 × outer Ø min.
Occasionally moved	> 6 × outer Ø min.

Standards / material properties









- Halogen free: IEC 60754-1, EN 50267-2-1
- No corrosive gases: IEC 60754-2, EN 50267-2-2
- No toxic gases: NF X 70-100
- Low smoke density: IEC 61034, DIN EN 61034-2, EN 50268-2
- Flame retardant: EN/IEC 60332-1-2
- Non-flame propagating: IEC 60332-3, DIN EN 60332-3, EN 50266-2
- Low fire load: DIN 51900

Approvals

- VDE approval no. 98673
- Gost R

Special features

- Special types and UL product range on request
- AWM Style 3666 approval available

Cross-section mm²	Outer Ø mm	Weight kg/km	Fire load kWh/m	Order no. (by Core colour)								
												
0.25	1.7	5	0.011	∅	∅	∅	∅	∅	∅	∅	∅	∅
0.50	2.2	9	0.017	218840	218312	218420	218631	218419	218630	218789	219650	
0.75	2.4	13	0.020	215437	214787	215260	215373	215272	216090	216116	216104	
1	2.5	15	0.021	215274	214788	214789	215261	214790	216307	216117	214785	
1.5	3.0	21	0.030	215334	215270	215264	215014	215263	217854	216118	215998	
2.5	3.7	33	0.043	215188	215035	215190	215374	215189	217855	216115	216114	
4	4.2	48	0.051	215283	215262	215271	218725	216316	218298	216322	220010	
6	4.8	68	0.060	215376	215655	215375	216149	216148	∅	216326	218726	
10	6.3	112	0.107	215277	215279	215281	∅	∅	∅	217213	∅	
16	7.8	172	0.143	215278	215280	215282	∅	∅	∅	∅	∅	
25	9.2	264	0.185	218248	216132	219947	∅	220596	∅	∅	∅	
35	10.4	355	0.227	218564	216318	218563	∅	218562	∅	∅	∅	
50	12.2	509	0.328	219456	216319	∅	∅	∅	∅	∅	∅	
70	14.2	707	0.454	300304	216320	304369	∅	∅	∅	∅	∅	
95	16.4	921	0.545	∅	216321	∅	∅	∅	∅	∅	∅	
120	18.4	1162	0.621	∅	∅	∅	∅	∅	∅	∅	∅	
150	20.8	1451	0.807	∅	∅	∅	∅	∅	∅	∅	∅	
185	22.9	1723	0.804	∅	∅	∅	∅	∅	∅	∅	∅	
240	25.8	2268	0.991	∅	∅	∅	∅	∅	∅	∅	∅	

BETAtrans® GWK R

Single core, volume optimised



Competitive advantage

- High flexibility
- Easy stripping
- Thin, weight and volume optimised
- Durable to mechanical stress
- Flame-retardant, halogen free
- Electron-beam cross-linked

BETAtrans® GWK R

Application

These cables with very small outer diameter are used where space is very limited.

Typical applications are in cabinets and control panels.

Construction

- Conductor Tinned fine copper strands acc. to VDE 0295/IEC 60228, class 5
- Insulation Polyolefine copolymer, electron-beam cross-linked
- Core colour white (other colours available on request)

Electrical properties

Nominal voltage

With fixed and protected installation U_0/U 600 / 1000 V

Testing voltage 3500 V

Thermal properties

Conductor temperature fixed installation +120 °C max.

Short-circuit temperature +280 °C max.

Ambient temperature fixed installation -50 °C min.

Bending radius

Fixed installation $> 3 \times$ outer \varnothing min.

Standards / material properties

- Non fluorine: EN 60684-2
- Halogen free: IEC 60754-1, EN 50267-2-1
- No corrosive gases: IEC 60754-2, EN 50267-2-2
- No toxic gases: NF X 70-100
- Resistance to oil and fuel: EN 50305, EN 60811-2-1
- Low smoke density: IEC 61034, DIN EN 61034-2, EN 50268-2
- Flame retardant: EN/IEC 60332-1-2
- Non-flame propagating: EN 50305
- Low fire load: DIN 51900

Approvals

- Gost R

Cross-section	Outer \varnothing	Weight	Fire load	Order no.
mm ²	mm	kWh / km	kWh / m	white
0.50	1.5	6.0	0.008	223220
0.75	1.7	8.0	0.010	223221
1	1.9	11.0	0.012	223222
1.5	2.3	16.0	0.017	223223
2.5	2.8	26.0	0.023	223224

BETAtherm® 145

Single core with increased environmental compatibility

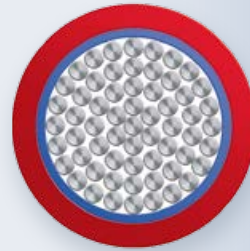

Competitive advantage

- Very high resistance to temperature
- service temperature up to +145 °C
- Resistance to cold down to -55 °C
- Best fire performance, halogen free
- Electron-beam cross-linked
- Different approvals available

BETAtherm® 145 SO 07Z - K

Application

Typical applications are internal wiring in lamps, heating appliances, electric machines (thermal class B) switchboards and distribution boxes in apparatus, mechanical and plant engineering.

Used for laying in tubes, surface wiring, direct in plaster or underneath it, as well in conduits. May not be laid directly in cable trays, cable racks or cable troughs.

Construction

- Conductor Tinned fine copper strands acc. to VDE 0295/IEC 60228, class 5
- Insulation Polyolefine copolymer, electron-beam cross-linked
- Core colour (further colours upon request)

Electrical properties

Nominal voltage	$U_0/U \leq 1 \text{ mm}^2$	300 / 500 V
	$U_0/U \geq 1.5 \text{ mm}^2$	450 / 750 V
With fixed and protected installation	$U_0/U \geq 1.5 \text{ mm}^2$	600 / 1000 V
Testing voltage	5000 V	

Thermal properties

Conductor temperature	fixed installation	+145 °C max.
	occasionally moved	+120 °C max.
Short-circuit temperature		+280 °C max.
Ambient temperature	fixed installation	-55 °C min.
	occasionally moved	-35 °C min.

Bending radius













Fixed installation	> 4 × outer Ø min.
Occasionally moved	> 6 × outer Ø min.

Standards / material properties

- Halogen free: IEC 60754-1, EN 50267-2-1
- No corrosive gases: IEC 60754-2, EN 50267-2-2
- No toxic gases: NF X 70-100
- Low smoke density: IEC 61034, DIN EN 61034-2, EN 50268-2
- Flame retardant: EN/IEC 60332-1-2
- Non-flame propagating: IEC 60332-3, DIN EN 60332-3, EN 50266-2
- Low fire load: DIN 51900

Approvals

- VDE permission no. 9887
- Germanischer Lloyd (GL) certificate no. 96630 - 94 HH
- Lloyd's Register (LR) certificate no. 03 / 20056
- BUREAU VERITAS (BV) certificate no. 13349 / B1 BV
- DNV certificate no. E - 8964
- CHINA CLASSIFICATION SOCIETY (CCS) certificate no. HB11W00001_01
- Gost R

Cross-section mm ²	Outer Ø mm	Weight kg / km	Fire load kWh / m	Order no. (by Core colour)											
															
0.25	1.6	5	0.009	190799	190792	190794	190797	190798	190793	∅	190795	215088	∅	212324	190796
0.33	1.7	6	0.010	∅	213862	∅	∅	212377	214206	∅	∅	∅	∅	∅	∅
0.50	1.9	8	0.012	190815	190808	190810	190813	190814	190809	191558	190811	211454	213414	219356	190812
0.75	2.2	11	0.017	190823	190816	190818	190821	190822	190817	191676	190819	211399	211663	211662	190820
1	2.4	14	0.020	190831	190824	190826	190829	190830	190825	191548	190827	191551	191550	191549	190828
1.5	3.0	20	0.030	190839	190832	190834	190837	190838	190833	191553	190835	191554	191552	191555	190836
2.5	3.7	32	0.043	190847	190840	190842	190845	190846	190841	211700	190843	211400	212277	212276	190844
4	4.2	46	0.051	190855	190848	190850	190853	190854	190849	304349	190851	211401	∅	300694	190852
6	4.7	65	0.060	190863	190856	190858	190861	190862	190857	216824	190859	211864	∅	∅	∅
10	6.1	108	0.097	191557	190864	191556	218311	217184	218511	304234	∅	211865	∅	∅	∅
16	7.2	164	0.127	211335	190865	211334	212169	211333	∅	301297	∅	211866	∅	∅	∅
25	8.6	247	0.168	212373	190866	213563	∅	∅	∅	∅	∅	211867	∅	∅	∅
35	10.1	349	0.225	211496	190867	215266	∅	∅	∅	∅	∅	∅	∅	∅	∅
50	12.5	507	0.348	211574	190868	215265	∅	217185	∅	∅	∅	∅	∅	∅	∅
70	14.0	691	0.404	211984	190869	300541	∅	∅	∅	220111	∅	∅	∅	∅	∅
95	16.0	912	0.500	213697	190870	∅	∅	∅	∅	∅	∅	∅	∅	∅	∅
120	17.8	1138	0.555	∅	210750	∅	∅	∅	∅	∅	∅	∅	∅	∅	∅
150	20.0	1436	0.761	219494	210751	∅	∅	∅	∅	∅	∅	∅	∅	∅	∅
185	21.9	1725	0.838	∅	191675	∅	∅	∅	∅	∅	∅	∅	∅	∅	∅
240	25.1	2278	1.043	∅	210752	∅	∅	∅	∅	∅	∅	∅	∅	∅	∅
300	28.1	2872	1.341	∅	301298	∅	∅	∅	∅	∅	∅	∅	∅	∅	∅

BETAtherm® 145 UL/CSA UL 3266/CSA AWM I A/B 125 °C/300 V | UL 3271 / CSA AWM I A/B 125 °C/600 V

Single core with increased environmental compatibility



Competitive advantage

- Very high resistance to temperature
- Resistance to cold down to -55°C
- Best fire performance, halogen free
- Electron-beam cross-linked

BETAtherm® 145 UL/CSA

Application

Typical applications are internal wiring in lamps, heating appliances, electric machines (thermal class B) switchboards and distribution boxes in apparatus, mechanical and plant engineering.

Used for laying in tubes, surface wiring, direct in plaster or underneath it, as well in conduits. May not be laid directly in cable trays, cable racks or cable troughs.

Construction

- Conductor Tinned fine copper strands acc. to VDE 0295/IEC 60228, class 5 and AWG
- Insulation Polyolefine copolymer, electron-beam cross-linked
- Core colour  (further colours upon request)

Electrical properties

Nominal voltage	U_0/U UL 3266	300 V
	U_0/U UL 3271	600 V
Testing voltage	UL 3266	2000 V
	UL 3271	3500 V

Thermal properties

Conductor temperature	fixed installation	$+125^{\circ}\text{C}$ max.
	occasionally moved	$+120^{\circ}\text{C}$ max.
Short-circuit temperature		$+280^{\circ}\text{C}$ max.
Ambient temperature	fixed installation	-55°C min.
	occasionally moved	-35°C min.

Bending radius

Fixed installation	$> 4 \times$ outer \varnothing min.
Occasionally moved	$> 6 \times$ outer \varnothing min.













Standards / material properties

- Halogen free: IEC 60754-1, EN 50267-2-1
- No corrosive gases: IEC 60754-2, EN 50267-2-2
- No toxic gases: NF X 70-100
- Low smoke density: IEC 61034, DIN EN 61034-2, EN 50268-2
- Flame retardant: EN/IEC 60332-1-2, FT1, FT2
- Non-flame propagating: IEC 60332-3, DIN EN 60332-3, EN 50266-2
- Low fire load: DIN 51900













Approvals

- UL AWM 3266, AWM 3271, File No. E146164
- CSA AWM I A/B (with the exception of AWG 24)
- Gost R

Dimensions, weights acc. to UL 3266 / CSA AWM I A/B 125°C / 300V

Cross-section		Outer Ø	Weight	Fire load	Order no. (by Core colour)											
AWG	(mm ²)	mm	kg/km	kWh/m												
24	(0.24)	1.5	4	0.008	∅	303235	304780	304778	303234	220358	304780	303236	304781	∅	∅	304779
22	(0.38)	1.6	6	0.009	∅	211242	218714	216472	216473	216471	218714	216475	216477	216474	216476	211559
20	(0.61)	1.8	8	0.011	300828	218669	218398	218397	218406	225096	∅	225150	218775	∅	∅	218407
18	(0.96)	2.1	12	0.013	211610	211613	211612	216479	211611	216636	∅	216637	221956	∅	∅	215826
16	(1.34)	2.3	16	0.015	216480	218239	216483	216638	225292	225291	∅	216482	216484	∅	216481	222519
14	(2.38)	2.7	24	0.020	∅	303954	303956	∅	303955	∅	∅	∅	219889	∅	∅	∅
12	(4)	3.3	42	0.023	∅	∅	∅	∅	∅	∅	∅	∅	∅	∅	∅	∅
10	(6)	4.1	61	0.032	∅	∅	∅	∅	∅	∅	∅	∅	∅	∅	∅	∅

Dimensions, weights acc. to UL 3271 / CSA AWM I A/B 125°C / 600V

Cross-section		Outer Ø	Weight	Fire load	Order no. (by Core colour)											
mm ²	(AWG)	mm	kg/km	kWh/m												
0.25	(24)	2.3	8	0.022	∅	304753	∅	∅	225108	∅	225107	∅	∅	∅	∅	∅
0.50	(22)	2.5	11	0.025	∅	221177	222990	∅	222989	302073	306002	∅	221176	∅	302030	301527
0.75	(20)	2.8	14	0.029	∅	217848	∅	∅	∅	219786	∅	∅	303131	∅	∅	∅
1	(18)	2.9	17	0.031	302017	225254	305359	305358	302031	∅	216996	∅	216994	∅	∅	305357
1.5	(16)	3.2	22	0.036	224097	224489	∅	∅	302289	303132	306011	∅	303129	∅	305170	∅
2.5	(14)	3.7	33	0.043	300461	216999	221987	224490	221985	221986	224492	∅	303133	300732	300731	∅
4	(12)	4.2	46	0.051	304777	217676	304756	301052	305633	305579	∅	305640	218909	300734	300733	∅
6	(10)	4.7	65	0.060	217000	216995	302472	300736	224493	305569	∅	305634	300735	300752	300751	∅
10	(8)	6.5	114	0.120	302474	215237	302473	∅	∅	∅	∅	∅	305621	∅	∅	∅
16	(6)	8.2	182	0.198	221578	217350	302481	∅	∅	∅	∅	∅	304879	∅	∅	∅
25	(4)	9.4	264	0.234	304757	218771	∅	∅	∅	∅	∅	∅	305242	∅	∅	∅
35	(2)	10.9	369	0.302	217795	215168	∅	∅	∅	∅	∅	∅	220434	∅	∅	∅
50	(1)	14.1	558	0.543	224713	217892	∅	∅	∅	∅	∅	∅	223143	∅	∅	∅
70	(2/0)	15.6	747	0.621	∅	223144	∅	∅	∅	∅	∅	∅	∅	∅	∅	∅
95	(3/0)	17.2	959	0.682	302018	304688	∅	∅	∅	∅	∅	∅	∅	∅	∅	∅
120	(4/0)	19.0	1190	0.758	∅	300009	∅	∅	∅	∅	∅	∅	∅	∅	∅	∅

BETAtherm® 145 UL/cUL UL 3820 / cUL AWM I A/B 125 °C / 1000 V

Single core with increased environmental compatibility



Competitive advantage

- Very high resistance to temperature
- Resistance to cold down to -55 °C
- Best fire performance, halogen free
- Electron-beam cross-linked
- Nominal voltage 1000 V

BETAtherm® 145 UL/cUL

Application

Typical applications are internal wiring in lamps, heating appliances, electric machines (thermal class B) switchboards and distribution boxes in apparatus, mechanical and plant engineering and inverters.

Used for laying in tubes, surface wiring, direct in plaster or underneath it, as well in conduits. May not be laid directly in cable trays, cable racks or cable troughs.

Construction

- Conductor Tinned fine copper strands acc. to VDE 0295/IEC 60228, class 5 (AWG upon request)
- Insulation Polyolefine copolymer, electron-beam cross-linked
- Core colour  (further colours upon request)

Electrical properties

Nominal voltage	U ₀ /U	1000 V
Testing voltage		3500 V

Thermal properties

Conductor temperature	fixed installation	+125 °C max.
	occasionally moved	+120 °C max.
Short-circuit temperature		+280 °C max.
Ambient temperature	fixed installation	-55 °C min.
	occasionally moved	-35 °C min.

Bending radius











Fixed installation	> 4 × outer Ø min.
Occasionally moved	> 6 × outer Ø min.

Standards / material properties

- Halogen free: IEC 60754-1, EN 50267-2-1
- No corrosive gases: IEC 60754-2, EN 50267-2-2
- No toxic gases: NF X 70-100
- Low smoke density: IEC 61034, DIN EN 61034-2, EN 50268-2
- Flame retardant: EN/IEC 60332-1-2, FT1, FT2
- Non-flame propagating: IEC 60332-3, DIN EN 60332-3, DIN EN 50266-2
- Low fire load: DIN 51900

Approvals

- UL AWM Style 3820, 125° C 1000 V, File no. E146164
- cUL AWM I A/B 125 °C / 1000 V
(cUL approbation is equivalent to CSA)

Cross-section		Outer Ø	Weight	Fire load	Order no. (by Core colour)												
mm ²	(AWG)	mm	kg / km	kWh / m													
0.25	(24)	2.3	8	0.022	Ø	308226	Ø	Ø	Ø	Ø	Ø	Ø	Ø	Ø	Ø	Ø	
0.50	(22)	2.5	11	0.025	Ø	308227	Ø	Ø	Ø	Ø	Ø	Ø	Ø	Ø	Ø	Ø	
0.75	(20)	2.8	14	0.029	Ø	308228	Ø	Ø	Ø	Ø	Ø	Ø	Ø	Ø	Ø	Ø	
1	(18)	2.9	17	0.031	308241	308229	Ø	Ø	Ø	Ø	Ø	Ø	Ø	Ø	Ø	Ø	
1.5	(16)	3.2	22	0.036	308242	308230	Ø	Ø	Ø	Ø	Ø	Ø	Ø	Ø	Ø	Ø	
2.5	(14)	3.7	32	0.043	308243	307908	307897	Ø	Ø	Ø	Ø	Ø	Ø	Ø	Ø	Ø	
4	(12)	4.2	46	0.051	308244	307656	307900	Ø	307899	307898	Ø	Ø	Ø	307901	Ø	Ø	
6	(10)	4.7	65	0.060	308245	307658	308205	Ø	307903	307902	Ø	Ø	Ø	Ø	Ø	Ø	
10	(8)	6.5	114	0.120	308246	307659	Ø	Ø	Ø	Ø	Ø	Ø	Ø	Ø	Ø	Ø	
16	(6)	8.2	182	0.198	308247	308231	Ø	Ø	Ø	Ø	Ø	Ø	Ø	Ø	Ø	Ø	
25	(4)	9.4	264	0.234	308248	308232	Ø	Ø	Ø	Ø	Ø	Ø	Ø	Ø	Ø	Ø	
35	(2)	10.9	369	0.302	308253	308237	Ø	Ø	Ø	Ø	Ø	Ø	Ø	Ø	Ø	Ø	
50	(1)	14.1	555	0.543	308254	308238	Ø	Ø	Ø	Ø	Ø	Ø	Ø	Ø	Ø	Ø	
70	(2/0)	16.6	747	0.621	Ø	308239	Ø	Ø	Ø	Ø	Ø	Ø	Ø	Ø	Ø	Ø	
95	(3/0)	17.2	959	0.682													
120	(4/0)	19.0	1190	0.758													

BETAtherm® 155 – Thermal class F

Single core with increased resistance to temperature



Competitive advantage

- Very high resistance to temperature, service temperature up to +155 °C
- Flame retardant, low smoke density
- Electron-beam cross-linked
- Insensitive to the conventional insulating varnishes

BETAtherm® 155

Application

BETAtherm® 155 is an electron-beam cross-linked and temperature resistant single core for the internal wiring of lamps, heating appliances and electric machines (thermal class F), in apparatus, mechanical and plant engineering.

When laid in a protective casing, they may be subjected to a nominal voltage of up to 1000 V AC or up to 750 V DC to earth.

The single core is insensitive to conventional insulating varnishes and enables high stove enamelling temperatures to be used during the processing.

Construction

- Conductor Tinned fine copper strands acc. to VDE 0295/IEC 60228, class 5
- Insulation Polyolefine copolymer, electron-beam cross-linked
- Core colour (further colours upon request)

Electrical properties

Nominal voltage	$U_0/U \leq 1 \text{ mm}^2$	300 / 500 V
	$U_0/U \geq 1.5 \text{ mm}^2$	450 / 750 V
With fixed and protected installation	$U_0/U \geq 1.5 \text{ mm}^2$	600 / 1000 V
Testing voltage		5000 V

Thermal properties

Conductor temperature	fixed installation	+155 °C max.
	occasionally moved	+120 °C max.
Short-circuit temperature		+280 °C max.
Ambient temperature	fixed installation	-55 °C min.
	occasionally moved	-35 °C min.

Bending radius

Fixed installation	> 4 × outer Ø min.
Occasionally moved	> 6 × outer Ø min.

Standards / material properties

- Flame retardant: EN/IEC 60332-1-2
- Resistance to temperature: IEC 60216-2, 155 °C / 5000 h

Approvals

- Gost R

Cross-section	Outer Ø	Weight	Fire load
mm ²	mm	kg / km	kWh / m
0.25	1.6	4	0.016
0.33	1.7	5	0.012
0.50	1.9	7	0.021
0.75	2.2	10	0.029
1	2.4	13	0.034
1.5	3.0	19	0.051
2.5	3.7	30	0.074
4	4.2	44	0.088
6	4.7	62	0.102
10	6.1	103	0.166
16	7.0	155	0.196
25	8.6	239	0.288
35	10.1	337	0.385
50	12.5	490	0.596
70	14.0	670	0.693
95	16.0	887	0.857
120	17.8	1109	0.952
150	20.0	1396	1.305

Order no. (by Core colour)											
Ø	190151	190153	190154	190152	190155	Ø	Ø	211761	Ø	Ø	190157
Ø	Ø	Ø	Ø	Ø	Ø	Ø	Ø	Ø	Ø	Ø	Ø
190173	190167	190169	190086	190168	190170	Ø	190171	211794	Ø	Ø	190172
190180	190174	190175	190176	190087	190177	Ø	190178	210856	Ø	Ø	190179
190188	190181	190183	190184	190182	190185	Ø	190186	Ø	Ø	Ø	190187
190196	190189	190191	190192	190190	190193	Ø	190195	211597	Ø	Ø	190194
190204	190197	190199	190200	190198	190201	Ø	190203	211795	Ø	Ø	190202
190212	190205	190207	190208	190206	190209	Ø	190211	Ø	Ø	Ø	190210
190714	190347	190717	190718	190348	190716	Ø	190350	Ø	Ø	Ø	190349
211245	190351	191111	Ø	191112	190361	Ø	212048	Ø	Ø	Ø	Ø
211131	190352	Ø	Ø	Ø	Ø	Ø	Ø	Ø	Ø	Ø	Ø
211265	190353	Ø	Ø	Ø	Ø	Ø	Ø	Ø	Ø	Ø	Ø
Ø	190307	Ø	Ø	Ø	Ø	Ø	Ø	Ø	Ø	220080	Ø
Ø	190355	Ø	Ø	Ø	Ø	Ø	Ø	Ø	Ø	Ø	Ø
Ø	191341	Ø	Ø	Ø	Ø	Ø	Ø	Ø	Ø	Ø	Ø
Ø	190691	Ø	Ø	Ø	Ø	Ø	Ø	Ø	Ø	Ø	Ø
Ø	191224	Ø	Ø	Ø	Ø	Ø	Ø	Ø	Ø	Ø	Ø
Ø	211824	Ø	Ø	Ø	Ø	Ø	Ø	Ø	Ø	Ø	Ø

BETAtherm® 155 UL/CSA UL 3289 / CSA CL 1503 150 °C / 600 V

Single core with increased resistance to temperature

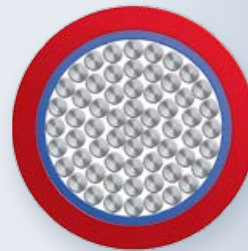

Competitive advantage

- Very high resistance to temperature, service temperature up to +150 °C
- Flame retardant, low smoke density
- Electron-beam cross-linked
- Insensitive to the conventional insulating varnishes

BETAtherm® 155 UL/CSA

Application

BETAtherm® 155 UL / CSA is an electron-beam cross-linked and temperature resistant single core for the internal wiring of lamps, heating appliances and electric machines (thermal class F), in apparatus, mechanical and plant engineering.

When laid in a protective casing, they may be subjected to a nominal voltage of up to 1000 V AC or up to 750 V DC to earth.

The single core is insensitive to conventional insulating varnishes and enables high stove enamelling temperatures to be used during the processing.

Construction

- Conductor Tinned fine copper strands acc. to VDE 0295/IEC 60228, class 5
- Insulation Polyolefine copolymer, electron-beam cross-linked
- Core colour  (further colours upon request)

Electrical properties

Nominal voltage	U_0/U	600 V
Testing voltage		5000 V

Thermal properties

Conductor temperature	fixed installation	+150 °C max.
	occasionally moved	+120 °C max.
Short-circuit temperature		+280 °C max.
Ambient temperature	fixed installation	-55 °C min.
	occasionally moved	-35 °C min.

Bending radius

Fixed installation	> 4 × outer Ø min.
Occasionally moved	> 6 × outer Ø min.













Standards / material properties

- Flame retardant: EN/IEC 60332-1-2
- Resistance to temperature: IEC 60216-2, 155 °C / 5000 h













Approvals

- UL AWM 3289, file no. E146164
- CSA CL 1503

Dimensions, weights according to AWG

Cross-section		Outer Ø	Weight	Fire load	Order no. (by Core colour)												
AWG	(mm ²)	mm	kg/km	kWh/m													
22	(0.38)	2.4	9	0.036	Ø	210883	210885	217233	210884	211833	Ø	Ø	Ø	Ø	Ø	Ø	210882
20	(0.61)	2.6	11	0.041	Ø	210889	210891	217553	210890	211835	Ø	211834	Ø	217554	Ø	Ø	210888
18	(0.96)	2.9	16	0.048	212188	210893	210895	212773	210894	211839	Ø	211840	Ø	219660	Ø	Ø	210892
16	(1.32)	3.1	19	0.053	212389	210897	210899	212772	210898	211841	Ø	Ø	Ø	Ø	Ø	Ø	210896
14	(2.09)	3.5	28	0.065	212434	210901	210903	214478	210902	211843	Ø	Ø	Ø	Ø	Ø	Ø	210900

Dimensions, weights according to mm²

Cross-section		Outer Ø	Weight	Fire load	Order no. (by Core colour)												
mm ²	(AWG)	mm	kg/km	kWh/m													
0.50	(22)	2.5	10	0.041	Ø	218995	Ø	Ø	210889	Ø	Ø	Ø	Ø	Ø	Ø	Ø	Ø
0.75	(20)	2.8	13	0.047	Ø	218997	Ø	Ø	Ø	219786	Ø	Ø	Ø	Ø	Ø	Ø	Ø
1	(18)	2.9	15	0.049	Ø	218999	Ø	Ø	Ø	Ø	Ø	Ø	Ø	Ø	Ø	Ø	Ø
1.5	(16)	3.2	20	0.057	221283	219001	Ø	Ø	Ø	Ø	Ø	Ø	Ø	Ø	Ø	Ø	Ø
2.5	(14)	3.7	30	0.070	Ø	219003	Ø	Ø	Ø	Ø	Ø	Ø	Ø	Ø	Ø	Ø	Ø
4	(12)	4.2	45	0.082	Ø	Ø	Ø	Ø	Ø	Ø	Ø	Ø	Ø	Ø	Ø	Ø	Ø
6	(10)	4.7	64	0.096	Ø	217134	Ø	Ø	Ø	Ø	Ø	Ø	Ø	Ø	Ø	Ø	Ø
10	(8)	6.5	109	0.194	Ø	219535	Ø	Ø	Ø	Ø	Ø	Ø	Ø	Ø	Ø	Ø	Ø
16	(6)	8.2	177	0.341	Ø	217633	Ø	Ø	Ø	Ø	Ø	Ø	Ø	Ø	Ø	Ø	Ø
25	(4)	9.4	259	0.412	Ø	218453	Ø	Ø	Ø	Ø	Ø	Ø	Ø	Ø	Ø	Ø	Ø
35	(2)	10.9	357	0.498	219033	219032	Ø	Ø	Ø	Ø	Ø	Ø	Ø	Ø	Ø	Ø	Ø
50	(1)	14.1	530	0.838	219035	219034	Ø	Ø	Ø	Ø	Ø	Ø	Ø	Ø	Ø	Ø	Ø
70	(2/0)	15.6	716	0.968	Ø	218476	Ø	Ø	Ø	Ø	Ø	Ø	Ø	Ø	Ø	Ø	Ø

BETAtherm® 120 1.8/3 kV

Single core with increased dielectric strength



Competitive advantage

- Excellent oil resistance
- High resistance to fuel
- Good resistance to weathering
- Flame-retardant, halogen free
- Electron-beam cross-linked
- Very durable to mechanical stress
- High short circuit and earth fault safety

BETAtherm® 120

Application

With the two-layered cable structure, which assures high dielectric strength and mechanical resistance, makes them suitable for short circuit and earth fault-proof installation. The thin outer layer offers additional protection against the influences of petroleum, oil and fuels.

Typical applications are the interior wiring of switchboards, converters and distributors.

Construction

- Conductor Tinned fine copper strands acc. to VDE 0295/IEC 60228, class 5
- Insulation Polyolefine copolymer, electron-beam cross-linked
- Outer layer Polyamide
- Core colour ● black (further colours upon request)

Electrical properties

Nominal voltage	U_0/U	1.8/3 kV
	V_0	2.7 kV DC
Testing voltage		6.5 kV

Thermal properties

Conductor temperature	fixed installation	+120 °C max.
	occasionally moved	+90 °C max.
Short-circuit temperature		+280 °C max.
Ambient temperature	fixed installation	-40 °C min.
	occasionally moved	-25 °C min.

Bending radius

Fixed installation	> 4 × outer Ø min.
Occasionally moved	> 6 × outer Ø min.

Standards / material properties

- Halogen free: IEC 60754-1, EN 50267-2-1
- No corrosive gases: IEC 60754-2, EN 50267-2-2
- No toxic gases: NF X 70-100
- Oil resistance: EN 60811-2-1
- Resistance to fuel: EN 60811-2-1
- Low smoke density: IEC 61034, DIN EN 61034-2, EN 50268-2
- Flame retardant: EN/IEC 60332-1-2
- Non-flame propagating: IEC 60332-3, DIN EN 60332-3, EN 50266-2
- Low fire load: DIN 51900

Approvals

- Gost R

Cross-section	Outer Ø	Weight	Fire load	Order no.
mm ²	mm	kg/km	kWh/m	black
1	2.7	15	0.032	212039
1.5	3.0	20	0.054	212040
2.5	3.7	32	0.071	212041
4	4.4	48	0.091	212042
6	5.1	70	0.121	212043
10	6.1	112	0.174	212044
16	7.6	170	0.249	212045

BETAtrans® 4 GKW-AX plus 1.8/3 kV

Single core with increased dielectric strength



Competitive advantage

- Resistance to cold up to -60°C
- Excellent oil resistance
- Best fire performance, halogen free
- Electron-beam cross-linked
- Flexible, thin and weight-optimised
- High short circuit and earth fault safety

BETAtrans® 4 GKW-AX plus

Application

With the two-layered cable structure, which assures high dielectric strength and mechanical resistance, makes them suitable for short circuit and earth fault-proof installation.

The thin outer layer offers additional protection against the influences of petroleum, oil and fuels.

Typical applications are the interior wiring of switchboards, converters and distributors.

Construction

- Conductor Tinned fine copper strands acc. to VDE 0295/IEC 60228, class 5
- Insulation Polyolefine copolymer, electron-beam cross-linked
- Outer layer Electron-beam cross-linked elastomer
- Core colour ● black (further colours upon request)

Electrical properties

Nominal voltage	U_0/U	1.8/3 kV
	V_0	2.7 kV DC
Testing voltage		6.5 kV

Thermal properties

Conductor temperature	fixed installation	$+120^{\circ}\text{C}$ max.
	occasionally moved	$+90^{\circ}\text{C}$ max.
Short-circuit temperature		$+280^{\circ}\text{C}$ max.
Ambient temperature	fixed installation	-60°C min.
	occasionally moved	-35°C min.

Bending radius

Fixed installation	$> 4 \times$ outer \varnothing min.
Occasionally moved	$> 6 \times$ outer \varnothing min.

Standards / material properties

- Non fluorine: EN 50684-2
- Halogen free: IEC 60754-1, EN 50267-2-1
- No corrosive gases: IEC 60754-2, EN 50267-2-2
- No toxic gases: NF X 70-100
- Oil resistance: EN 60811-2-1
- Resistance to fuel: EN 60811-2-1
- Low smoke density: IEC 61034, DIN EN 61034-2, EN 50268-2
- Flame retardant: EN/IEC 60332-1-2
- Non-flame propagating: IEC 60332-3, DIN EN 60332-3, EN 50266-2
- Low fire load: DIN 51900

Approvals

- Gost R

Special features

- EMC shielded design upon request
- FE design with insulation integrity upon request

Cross-section	Outer \varnothing	Weight	Fire load	Order no.
mm ²	mm	kg/km	kWh/m	black
1	2.8	17	0.03	222827
1.5	3.2	23	0.04	222082
2.5	3.7	33	0.05	222083
4	4.5	51	0.06	222084
6	5.1	71	0.08	222085
10	6.1	114	0.10	222086
16	7.8	176	0.17	222087
25	9.6	271	0.24	222088
35	11.4	384	0.34	222089
50	13.4	538	0.44	222090
70	14.9	725	0.51	222091
95	16.9	954	0.60	222092
120	19.2	1205	0.77	222093
150	21.0	1491	0.93	222094
185	22.8	1780	1.00	222095
240	26.1	2347	1.25	222096
300	29.1	2917	1.44	222097
400	33.5	3846	1.74	222098

BETAtrans® 9 GW-AX plus 3.6 / 6 kV

Single core with increased dielectric strength



Competitive advantage

- Resistance to cold up to -60°C
- Excellent oil resistance
- Best fire performance, halogen free
- Electron-beam cross-linked
- Flexible, thin and weight-optimised
- High short circuit and earth fault safety

BETAtrans® 9 GW-AX plus

Application

With the two-layered cable structure, which assures high dielectric strength and mechanical resistance, makes them suitable for short circuit and earth fault-proof installation.

The thin outer layer offers additional protection against the influences of petroleum, oil and fuels.

Typical applications are the interior wiring of switchboards, converters and distributors.

Construction

- Conductor Tinned fine copper strands acc. to VDE 0295/IEC 60228, class 5
- Insulation Polyolefine copolymer, electron-beam cross-linked
- Outer layer Electron-beam cross-linked elastomer
- Core colour ● black (further colours upon request)

Electrical properties

Nominal voltage	U_0/U	3.6 / 6 kV
	V_0	5.4 kV DC
Testing voltage		11 kV

Thermal properties

Conductor temperature	fixed installation	$+120^{\circ}\text{C}$ max.
	occasionally moved	$+90^{\circ}\text{C}$ max.
Short-circuit temperature		$+280^{\circ}\text{C}$ max.
Ambient temperature	fixed installation	-60°C min.
	occasionally moved	-35°C min.

Bending radius

Fixed installation	$> 4 \times$ outer \varnothing min.
Occasionally moved	$> 6 \times$ outer \varnothing min.

Standards / material properties

- Non fluorine: EN 50684-2
- Halogen free: IEC 60754-1, EN 50267-2-1
- No corrosive gases: IEC 60754-2, EN 50267-2-2
- No toxic gases: NF X 70-100
- Oil resistance: EN 60811-2-1
- Resistance to fuel: EN 60811-2-1
- Low smoke density: IEC 61034, DIN EN 61034-2, EN 50268-2
- Flame retardant: EN/IEC 60332-1-2
- Non-flame propagating: IEC 60332-3, DIN EN 60332-3, EN 50266-2
- Low fire load: DIN 51900

Approvals

- Gost R

Special features

- EMC shielded design upon request
- FE design with insulation integrity upon request

Cross-section	Outer \varnothing	Weight	Fire load	Order no.
mm ²	mm	kg / km	kWh / m	black
1.5	4.4	34	0.08	222931
2.5	4.9	46	0.09	222932
4	5.7	66	0.12	222933
6	6.3	88	0.14	222934
10	7.5	136	0.19	222935
16	8.9	198	0.25	222936
25	10.5	293	0.33	222937
35	12.2	407	0.43	222938
50	14.3	568	0.56	222939
70	15.8	759	0.64	222940
95	17.9	994	0.78	222941
120	19.9	1238	0.90	222942
150	21.9	1537	1.11	222943
185	23.6	1824	1.17	222944
240	26.9	2449	1.54	222945
300	29.9	3040	1.78	222946
400	34.7	3942	2.12	222947

Multi-core cables

BETAflam® · BETAtrans® · BETAdrive · ROFLEX®



Multi-core cables			Page
Multi-core cables overview			34
With increased environmental compatibility	BETAflam® INSTAflex	600 / 1000 V	36
	BETAflam® CHEMAflex	600 / 1000 V	38
	BETAflam® CHEMAflex R	300 / 500 V	40
	BETAflam® 145 flex	600 / 1000 V	42
	BETAflam® 145 flex UL/cUL 4486	1000 V	45
	BETAtrans® GKW flex R	600 / 1000 V	48
Shielded cable with increased environmental compatibility	BETAflam® CHEMA C-flex	600 / 1000 V	50
	BETAflam® CHEMA C-flex DR	300 / 500 V	51
	BETAflam® 145 C-flex	600 / 1000 V	53
	BETAflam® 145 C-flex UL 4486	1000 V	56
	BETAtrans® GKW C-flex R	600 / 1000 V	58
Shielded connection cables for motors	BETAdrive® C-flex	600 / 1000 V	60
	BETAdrive® C-flex FE180	600 / 1000 V	62
For rough ambient conditions	ROFLEX®	600 / 1000 V	64
For flexible heavy current connections	BETAflam® TRAFO-FLEX	600 / 1000 V	66

Multi-core cables overview

Flexible BETAflam®, BETAtrans®, BETAdrive® and ROFLEX® cable



With increased environmental compatibility

BETAflam® INSTAflex

600 / 1000 V, CH-N07Z1Z1-F

→ page 36



BETAflam® CHEMAflex

600 / 1000 V oil and chemical resistant
oil and chemical resistant

→ page 38



Shielded cable with increased environmental compatibility

BETAflam® CHEMA C-flex

600 / 1000 V oil and chemical resistant

→ page 50



BETAflam® CHEMA C-flex DR

300 / 500 V oil and chemical resistant

→ page 51



Shielded connection cables for motors

BETAdrive® C-flex

600 / 1000 V

→ page 60



BETAdrive® C-flex FE180

600 / 1000 V

→ page 62



For rough ambient conditions

ROFLEX®

600 / 1000 V, CH-N05BQ-F, CH-N1BQ-F

→ page 64



For flexible heavy current connections

BETAflam® TRAF0-FLEX

600 / 1000 V

→ page 66



**BETAflam® CHEMAflex R**

300 / 500 V oil and
chemical resistant
→ page 40

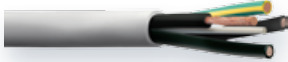
**BETAflam® 145 flex**

600/1000 V
temperature resistant
→ page 42

**BETAflam® 145 flex**

1000 V, UL/cUL AWM 4486
temperature resistant
→ page 45

**BETAtrans® GWK flex R**

600 / 1000 V
temperature resistance
→ page 48

**BETAflam® 145 C-flex**

600/1000 V
temperature resistance
→ page 53

**BETAflam® 145 C-flex**

1000 V, UL/cUL AWM 4486
temperature resistance
→ page 56

**BETAtrans® GWK C-flex R**

600 / 1000 V
temperature resistance
→ page 58



BETAflam® INSTAflex 600/1000 V

Installation cable – non-flame propagating, easy installation

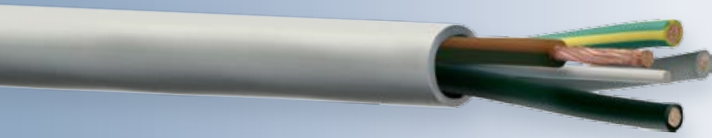

Competitive advantage

- Cost savings thanks to easy installation and laying
- Easy connection in constrained spaces
- Non-flame propagating, halogen free

BETAflam® INSTAflex CH-N07Z1Z1-F

Application

Installation cable with flexible conductor structure, suitable for:

- Systems in civil engineering
- Mechanical engineering
- Heating and air conditioning technology
- Particularly in applications where the absence of halogen, non-flame propagating, the absence of pollutants and a demanding laying mode are required
- Not for unprotected installation in ground or water

Construction

- Conductor Bare fine copper strands in accordance with IEC 60288, class 5
- Insulation BETAflam® copolymer, halogen free
- Core identification ≤ 5 cores acc. to HD 308 S2
≥ 6 cores, ● black with white numbers
- Sheath BETAflam® copolymer, halogen free
- Colour of sheath ● Grey

Electrical properties

Nominal voltage	U ₀ /U	450 / 750 V
With fixed installation	U ₀ /U	600 / 1000 V
Testing voltage		3500 V

Thermal properties

Conductor temperature	fixed installation	+80 °C max.
	occasionally moved	+80 °C max.
Short-circuit temperature		+160 °C max.
Ambient temperature	fixed installation	-40 °C min.
	occasionally moved	-25 °C min.

Bending radius

For fixed installation	> 4 × outer Ø
Occasionally moved	> 8 × outer Ø
Bending test	Medium duty (category 2) acc. to SEV TP 20B/3C

Standards / material properties

- Halogen free: IEC 60754-1, EN 50267-2-1
- No corrosive gases: IEC 60754-2, EN 50267-2-2
- Low smoke density: IEC 61034-2, EN 61034-2
- Flame retardant: IEC 60332-1, EN 60332-1
- Non-flame propagating: IEC 60332-3-24, EN 60332-3-10, -24
- Electrosuisse SEV TP 20B/3C-d

Approvals

- Electrosuisse certificate IK-2087
- ESTI approval no. 12.0695
- Gost R

Cable construction	Core function	Core Ø	Outer Ø	Weight	Cu factor	Order no.
n × mm ²		mm	mm	kg/km	kg/km	
3 G 1.5	LNPE	3.0	7.8	109	43	302518
4 G 1.5	3LPE	3.0	8.6	139	58	302519
5 G 1.5	3LNPE	3.0	9.6	173	72	302520
7 G 1.5	NRPE	3.0	11.7	245	101	302521
3 G 2.5	LNPE	3.7	10.5	160	72	302522
4 G 2.5	3LPE	3.7	11.5	203	96	302523
5 G 2.5	3LNPE	3.7	11.7	254	120	302524
7 G 2.5	NRPE	3.7	14.5	299	168	302525
4 G 4	3LPE	4.2	12.9	281	154	303225
5 G 4	3LNPE	4.2	13.3	349	192	302526
3 G 6	LNPE	4.8	13.6	297	173	303008
4 G 6	3LPE	4.8	14.9	389	230	303226
5 G 6	3LNPE	4.8	16.5	492	288	302527
4 G 10	3LPE	6.3	19.1	619	384	303227
5 G 10	3LNPE	6.3	21.3	779	480	302528
1 × 16	L	7.8	10.3	225	154	302529
1 G 16	PE	7.8	10.3	225	154	302530
4 G 16	3LPE	7.8	23.2	923	614	303228
5 G 16	3LNPE	7.8	25.8	1166	768	302531
1 × 25	L	9.2	11.9	335	240	302532
1 G 25	PE	9.2	11.9	335	240	302534
4 G 25	3LPE	9.2	27.3	1448	960	303229
5 G 25	3LNPE	9.2	30.0	1793	1200	302535

Cable construction	Core function	Core Ø	Outer Ø	Weight	Cu factor	Order no.
n × mm ²		mm	mm	kg/km	kg/km	
1 × 35	L	10.4	13.3	435	336	302536
1 G 35	PE	10.4	13.3	435	336	302537
4 G 35	3LPE	10.4	30.3	1891	1344	303230
5 G 35	3LNPE	10.4	33.7	2353	1680	302538
1 × 50	L	12.2	15.3	609	480	304054
1 G 50	PE	12.2	15.3	609	480	304055
4 G 50	3LPE	12.2	35.0	2644	1920	303231
5 G 50	3LNPE	12.2	39.9	3356	2400	∅
1 × 70	L	14.2	17.8	848	672	304426
1 G 70	PE	14.2	17.8	848	672	304427
1 × 95	L	16.4	20.2	1006	912	303115
1 G 95	PE	16.4	20.2	1006	912	∅
1 × 120	L	18.4	22.4	1362	1152	303116
1 G 120	PE	18.4	22.4	1362	1152	∅
1 × 150	L	20.8	25.2	1699	1440	303117
1 G 150	PE	20.8	25.2	1699	1440	∅
1 × 185	L	22.9	27.5	2007	1776	303119
1 G 185	PE	22.9	27.5	2007	1776	∅
1 × 240	L	25.8	30.6	2600	2304	303118
1 G 240	PE	25.8	30.6	2600	2304	∅
1 × 300	L	28.8	34.0	3223	2880	303120
1 G 300	PE	28.8	34.0	3223	2880	∅

G = with gn/ye core ●
L = phase conductor colour ●/numbered
● ● ●
N = neutral conductor colour ●
NR = phase conductor colour bk
●/numbered
PE = protective earth colour gn/ye ●
Further designs upon request

BETAflam® CHEMAflex 600/1000 V

Connection cable – flexible, crack-resistant, oil and chemical resistant



Competitive advantage

- Oil and chemical resistant
- Best fire performance, halogen free
- High temperature resistance 90°C (fixed installation)
- Good stress crack resistance

BETAflam® CHEMAflex

Application

Fixed and flexible application for average mechanical stress in dry, humid and wet rooms, especially under industrial ambient conditions.

Only outdoors in observance of the temperature range; do not install without UV protection and not in the ground.

Typical applications are:

- Conveying and automation systems
- Chemical industry / food industry
- Washing systems
- Paper industry
- Cheese dairies / butcheries
- Automotive manufacturers, etc.

Resistant to conventional cold cleaners and disinfectants in public buildings, commercial buildings and industry.

Construction

- Conductor Bare fine copper strands acc. to VDE 0295/IEC 60228, class 5
- Insulation Polyolefine copolymer
- Core identification ≤ 5 cores acc. to HD 308 S2 (see page 70)
≥ 6 cores
● black with white numbers or
● black with white numbers and ●
- Dual layer outer sheath Inside: Polyolefine copolymer
Outside: TPE-V
- Colour of sheath ● Grey

Electrical properties

Nominal voltage	$U_0/U \leq 1 \text{ mm}^2$	300 / 500 V
	$U_0/U \geq 1.5 \text{ mm}^2$	450 / 750 V
With fixed and protected installation	$U_0/U \geq 1.5 \text{ mm}^2$	600 / 1000 V
Testing voltage		3500 V

Thermal properties

Conductor temperature	fixed installation	+90°C max.
	occasionally moved	+80°C max.
Short-circuit temperature		+160°C max.
Ambient temperature	fixed installation	-40°C min.
	occasionally moved	-25°C min.

Bending radius

For fixed installation	> 4 × outer Ø
Occasionally moved	> 8 × outer Ø

Standards / material properties

- Halogen free: IEC 60754-1, EN 50267-2-1
- No corrosive gases: IEC 60754-2, EN 50267-2-2
- No toxic gases: NF X 70
- Oil resistance: EN 60811-2-1 (24 h/70°C)
- Chemical resistance: See table on page 76
- Low smoke density: IEC 61034-2, DIN EN 61034-2, EN 50268-2
- Flame retardant: IEC 60332-1, EN 60332-1
- Non-flame propagating: IEC 60332-3-24, DIN EN 60332-3, EN 50266-2-4
- Low fire load: DIN 51900

Approvals

- Gost R

Con- struction	Core function	Core Ø	Outer Ø	Weight	Fire load	Order no.
n × mm ²			mm	kg/km	kWh/m	
2 × 1.5	LN	3.0	8.2	79	0.25	∅
3 G 1.5	LNPE	3.0	8.8	105	0.30	223719
4 G 1.5	3LPE	3.0	9.6	134	0.36	223720
5 G 1.5	3LNPE	3.0	10.7	167	0.44	223721
2 × 2.5	LN	3.7	9.8	115	0.33	224881
3 G 2.5	LNPE	3.7	10.5	154	0.40	223722
4 G 2.5	3LPE	3.7	11.5	196	0.48	223723
5 G 2.5	3LNPE	3.7	12.7	246	0.59	223724
2 × 4	LN	4.2	10.9	153	0.38	∅
3 G 4	LNPE	4.2	11.5	205	0.44	∅
4 G 4	3LPE	4.2	12.9	270	0.57	225260
5 G 4	3LNPE	4.2	14.3	340	0.71	223725
2 × 6	LN	4.8	12.6	272	0.56	∅
3 G 6	LNPE	4.8	13.5	295	0.58	∅
4 G 6	3LPE	4.8	14.8	380	0.70	225261
5 G 6	3LNPE	4.8	16.4	476	0.88	223726
7 G 6	NRPE	4.8	19.8	700	1.00	225829
2 × 10	LN	6.3	16.0	378	0.90	∅
3 G 10	LNPE	6.3	17.3	470	0.94	∅
4 G 10	3LPE	6.3	19.1	612	1.18	223727
5 G 10	3LNPE	6.3	21.3	771	1.47	223728
2 × 16	LN	7.8	19.5	570	1.28	∅
3 G 16	LNPE	7.8	20.9	750	1.46	∅

Con- struction	Core function	Core Ø	Outer Ø	Weight	Fire load	Order no.
n × mm ²			mm	kg/km	kWh/m	
4 G 16	3LPE	7.8	23.2	912	1.62	223729
5 G 16	3LNPE	7.8	25.8	1153	2.05	223730
2 × 25	LN	9.2	22.7	836	1.75	∅
3 G 25	LNPE	9.2	24.3	1098	1.93	∅
4 G 25	3LPE	9.2	27.3	1368	2.15	223731
5 G 25	3LNPE	9.2	30.0	1710	2.66	223732
2 × 35	LN	10.4	25.5	1067	2.05	∅
3 G 35	LNPE	10.4	27.3	1452	2.39	∅
4 G 35	3LPE	10.4	30.3	1876	2.90	223733
5 G 35	3LNPE	10.4	34.0	2342	3.59	223734
2 × 50	LN	12.2	29.5	1480	2.69	∅
3 G 50	LNPE	12.2	31.4	2016	3.11	∅
4 G 50	3LPE	12.2	35.0	2628	3.86	223735
5 G 50	3LNPE	12.2	39.9	3328	5.06	223736
2 × 70	LN	14.2	34.5	2051	3.68	∅
3 G 70	LNPE	14.2	36.7	2799	4.27	∅
4 G 70	3LPE	14.2	41.5	3690	5.56	∅
5 G 70	3LNPE	14.2	45.9	4572	6.73	225576
2 × 95	LN	16.4	35.3	2660	4.68	∅
3 G 95	LNPE	16.4	42.3	3612	5.35	∅
4 G 95	3LPE	16.4	47.0	4747	6.76	∅
5 G 95	3LNPE	16.4	52.8	5957	8.48	∅

G = with gn/ye core ●

L = phase conductor colour

● ● ●

N = neutral conductor colour ●

NR= phase conductor colour bk

● /numbered

PE= protective earth colour gn/ye ●

Further designs upon request

BETAflam® CHEMAflex R 300/500 V

Connection cable – flexible, with reduced wall thickness, crack-resistant, oil and chemical resistant

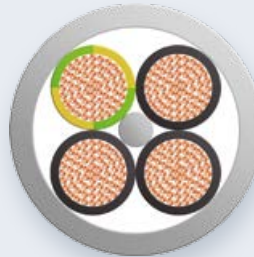

Competitive advantage

- Volume and weight optimised
- Oil and chemical resistant
- Best fire performance, halogen free
- High temperature resistance 90°C (fixed installation)
- Good stress crack resistance

BETAflam® CHEMAflex R

Application

Fixed and flexible application for average mechanical stress in dry, humid and wet rooms, especially under industrial ambient conditions.

Only outdoors in observance of the temperature range; do not install without UV protection and not in the ground.

Typical applications are:

- Conveying and automation systems
- Chemical industry / food industry
- Washing systems
- Paper industry
- Cheese dairies / butcheries
- Automotive manufacturers, etc.

Resistant to conventional cold cleaners and disinfectants in public buildings, commercial buildings and industry.

Construction

- | | |
|---------------------------|---|
| ■ Conductor | Bare fine copper strands
acc. to VDE 0295/IEC 60228, class 5 |
| ■ Insulation | Polyolefine copolymer |
| ■ Core identification | ≤ 2 ● black with white numbers
≥ 3 ● black with white numbers or
● black with white numbers and ● |
| ■ Dual layer outer sheath | Inside: Polyolefine copolymer
Outside: TPE-V |
| ■ Colour of sheath | ● Grey |

Electrical properties

Nominal voltage	300 / 500 V
Testing voltage	3500 V

Thermal properties

Conductor temperature	fixed installation	+90°C max.
	occasionally moved	+80°C max.
Short-circuit temperature		+160°C max.
Ambient temperature	fixed installation	-40°C min.
	occasionally moved	-25°C min.

Bending radius

For fixed installation	> 4 × outer Ø
Occasionally moved	> 8 × outer Ø

Standards / material properties

- Halogen free: IEC 60754-1, EN 50267-2-1
- No corrosive gases: IEC 60754-2, EN 50267-2-2
- No toxic gases: NF X 70 -100
- Oil resistance: EN 60811-2-1 (24 h / 70 °C)
- Chemical resistance: See table on page 76
- Low smoke density: IEC 61034, DIN EN 61034-2, EN 50268-2
- Flame retardant: EN/IEC 60332-1-2
- Non-flame propagating: IEC 60332-3, DIN EN 60332-3, EN 50266-2
- Low fire load: DIN 51900

Approvals

- Gost R

Con- struction	Core function	Core Ø	Outer Ø	Weight	Fire load	Order no.
n × mm ²		mm	mm	kWh/m		
2 × 0.5	NR	1.8	5.1	30	0.11	223678
3 G 0.5	NRPE	1.8	5.4	39	0.12	223679
3 × 0.5	NR	1.8	5.4	39	0.12	223680
4 G 0.5	NRPE	1.8	5.8	49	0.14	223681
4 × 0.5	NR	1.8	5.8	49	0.14	223682
5 G 0.5	NRPE	1.8	6.3	59	0.16	∅
7 G 0.5	NRPE	1.8	7.5	84	0.22	223683
12 G 0.5	NRPE	1.8	9.1	128	0.31	223684
2 × 0.75	NR	2.0	5.6	38	0.12	223685
3 G 0.75	NRPE	2.0	5.9	50	0.13	223686
3 × 0.75	NR	2.0	5.9	50	0.13	223687
4 G 0.75	NRPE	2.0	6.5	63	0.16	223688
4 × 0.75	NR	2.0	6.5	63	0.16	305178
5 G 0.75	NRPE	2.0	7.0	77	0.19	223689
7 G 0.75	NRPE	2.0	8.6	115	0.29	223690
12 G 0.75	NRPE	2.0	10.5	176	0.40	223691
18 G 0.75	NRPE	2.0	12.2	252	0.53	∅
25 G 0.75	NRPE	2.0	14.6	345	0.69	223692
2 × 1	NR	2.1	5.8	44	0.12	223693
3 G 1	NRPE	2.1	6.1	58	0.14	223694
3 × 1	NR	2.1	6.1	58	0.14	223695
4 G 1	NRPE	2.1	6.7	74	0.17	223696
4 × 1	NR	2.1	6.7	74	0.17	223697
5 G 1	NRPE	2.1	7.4	91	0.20	223698
7 G 1	NRPE	2.1	9.0	136	0.31	223699
8 G 1	NRPE	2.1	9.0	156	0.35	223700
8 × 1	NR	2.1	9.6	156	0.35	307317
10 G 1	NRPE	2.1	11.2	208	0.42	304996
12 G 1	NRPE	2.1	10.9	208	0.41	223701

Con- struction	Core function	Core Ø	Outer Ø	Weight	Fire load	Order no.
n × mm ²		mm	mm	kWh/m		
18 G 1	NRPE	2.1	12.8	302	0.56	223702
24 × 1	NR	2.1	15.2	404	0.70	307319
25 G 1	NRPE	2.1	15.2	412	0.73	223703
41 G 1	NRPE	2.1	19.5	700	1.27	304997
2 × 1.5	NR	2.4	6.4	54	0.14	223704
3 G 1.5	NRPE	2.4	6.8	72	0.16	223705
4 G 1.5	NRPE	2.4	7.4	93	0.19	223706
4 × 1.5	NR	2.4	7.4	93	0.19	304999
5 G 1.5	NRPE	2.4	8.6	123	0.27	223707
7 G 1.5	NRPE	2.4	10.4	181	0.40	223708
8 G 1.5	NRPE	2.4	11.2	209	0.46	∅
10 G 1.5	NRPE	2.4	12.5	264	0.49	304998
12 G 1.5	NRPE	2.4	12.2	264	0.48	223709
18 G 1.5	NRPE	2.4	14.2	383	0.64	223710
25 G 1.5	NRPE	2.4	17.7	552	0.96	223711
2 × 2.5	NR	3.1	8.2	89	0.22	305175
3 G 2.5	NRPE	3.1	8.7	119	0.25	223712
4 G 2.5	NRPE	3.1	9.6	153	0.30	223713
5 G 2.5	NRPE	3.1	10.8	198	0.40	223714
7 G 2.5	NRPE	3.1	12.6	277	0.55	223715
12 G 2.5	NRPE	3.1	15.1	412	0.67	305176
4 G 4	NRPE	3.6	11.2	228	0.40	223716
5 G 4	NRPE	3.6	12.2	280	0.47	223717
7 G 4	NRPE	3.6	14.3	394	0.65	305174
4 G 6	NRPE	4.4	13.0	328	0.51	305177
5 G 6	NRPE	4.4	15.0	430	0.71	223718
7 G 6	NRPE	4.4	17.6	605	0.98	224725

G = with gn/ye core ●

NR= phase conductor colour bk ● / numbered

PE= protective earth colour gn/ye ●

Further designs upon request

BETAflam® 145 flex 600/1000 V

Connection and power cable – temperature resistant



Competitive advantage

- Very high resistance to temperature, service temperature up to +145 °C
- Resistance to cold down to -55 °C
- Best fire performance, halogen free
- Good media resistance
- Electron-beam cross-linked

BETAflam® 145 flex

Application

Fixed and flexible application in dry, humid and wet rooms. Good weather and UV resistance. Extensively oil resistant. Intended for installation outdoors. Typical areas of application are connections of:

- Lamps
- Heating units
- Electrical machinery (thermal class B)
- Switchboards / switch cabinets and distributors in apparatus, mechanical or plant engineering

Construction

- Conductor Tinned fine copper strands acc. to VDE 0295/IEC 60228, class 5
- Insulation Polyolefine copolymer electron-beam cross-linked
- Core identification ≤ 5 cores acc. to HD 308 S2 (see page 70)
≥ 6 cores
● black with white numbers or
● black with white numbers and ●
- Outer sheath Polyolefine copolymer electron-beam cross-linked
- Colour of sheath ● black

Electrical properties

Nominal voltage	$U_0/U \leq 1 \text{ mm}^2$	300 / 500 V
	$U_0/U \geq 1.5 \text{ mm}^2$	450 / 750 V
With fixed and protected installation	$U_0/U \geq 1.5 \text{ mm}^2$	600 / 1000 V
Testing voltage		3500 V

Thermal properties

Conductor temperature	fixed installation	+145 °C max.
	occasionally moved	+120 °C max.
Short-circuit temperature		+280 °C max.
Ambient temperature	fixed installation	-55 °C min.
	occasionally moved	-35 °C min.

Bending radius

For fixed installation	> 4 × outer Ø
Occasionally moved	> 8 × outer Ø

Standards / material properties

- Halogen free: IEC 60754-1, EN 50267-2-1
- No corrosive gases: IEC 60754-2, EN 50267-2-2
- No toxic gases: NF X 70-100
- Low smoke density: IEC 61034, DIN EN 61034-2, EN 50268-2
- Flame retardant: EN/IEC 60332-1-2
- Non-flame propagating: IEC 60332-3, DIN EN 60332-3, EN 50266-2, NF C 32-070
- Low fire load: DIN 51900

Approvals

- Germanischer Lloyd (GL)
- Lloyd's Register (LR)
- BUREAU VERITAS (BV)
- DET Norske Veritas (DNV)
- CHINA CLASSIFICATION SOCIETY (CCS)
- ClassNK (Nippon)
- Gost R

Special features

Special types upon request

Con- struction	Core function	Core Ø	Outer Ø	Weight	Fire load	Order no.
n × mm ²			mm	kg / km	kWh / m	
2 × 0.5	LN	1.9	5.1	38	0.11	214001
3 G 0.5	LNPE	1.9	5.5	46	0.13	∅
4 G 0.5	NRPE	1.9	5.9	55	0.14	∅
4 × 0.5	NR	1.9	5.9	55	0.14	219379
5 G 0.5	3LNPE	1.9	6.7	68	0.19	∅
6 G 0.5	NRPE	1.9	7.1	77	0.21	∅
7 G 0.5	NRPE	1.9	7.8	93	0.26	∅
8 G 0.5	NRPE	1.9	8.6	102	0.30	∅
10 G 0.5	NRPE	1.9	9.4	130	0.32	∅
12 G 0.5	NRPE	1.9	9.4	125	0.32	∅
14 G 0.5	NRPE	1.9	10.0	146	0.33	∅
16 G 0.5	NRPE	1.9	10.7	166	0.38	∅
2 × 0.75	LN	2.2	5.9	52	0.15	213874
2 × 0.75	NR	2.2	5.9	52	0.15	217588
3 G 0.75	LNPE	2.2	6.2	61	0.16	216630
3 × 0.75	NR	2.2	6.2	61	0.16	223848
4 × 0.75	NR	2.2	6.9	75	0.19	220752
4 G 0.75	3LPE	2.2	6.9	75	0.19	222788
4 G 0.75	2LNPE	2.2	6.9	69	0.19	216328
5 G 0.75	3LNPE	2.2	7.7	94	0.25	222910
5 × 0.75	NR	2.2	7.7	94	0.25	223774
6 G 0.75	NR	2.2	8.3	107	0.28	222161
6 G 0.75	NRPE	2.2	8.3	107	0.28	226089
7 G 0.75	NRPE	2.2	9.1	127	0.35	218510
8 G 0.75	NRPE	2.2	10.2	144	0.35	213641
10 G 0.75	NR	2.2	11.1	186	0.75	214566
10 G 0.75	NRPE	2.2	11.1	186	0.75	302843
12 G 0.75	NRPE	2.2	11.1	178	0.38	221971
14 G 0.75	NRPE	2.2	11.7	203	0.43	∅
16 G 0.75	NRPE	2.2	12.5	233	0.51	302844
1 × 1	L	2.4	3.9	25	0.06	∅
2 × 1	LN	2.4	6.3	48	0.12	219674
2 × 1	NR	2.4	6.3	48	0.12	218860
3 G 1	LNPE	2.4	6.8	65	0.15	214075
3 × 1	NR	2.4	6.8	65	0.15	301676
4 G 1	3LPE	2.4	7.4	82	0.19	222969
4 × 1	NR	2.4	7.4	82	0.19	224018
4 G 1	2LNPE	2.4	7.4	82	0.19	218509
5 G 1	3LNPE	2.4	8.3	104	0.25	222911
5 G 1	NRPE	2.4	8.3	104	0.25	218863
5 × 1	NR	2.4	8.3	104	0.25	220309
6 G 1	NRPE	2.4	8.9	124	0.30	∅
7 G 1	NRPE	2.4	9.9	151	0.39	218864
8 G 1	NRPE	2.4	11.0	177	0.40	∅
10 G 1	NRPE	2.4	12.1	222	0.47	∅
12 G 1	NRPE	2.4	12.1	221	0.46	218859
14 G 1	NRPE	2.4	12.7	252	0.50	∅
16 G 1	NRPE	2.4	13.6	290	0.59	∅
19 G 1	NRPE	2.4	15.1	338	0.74	223244
21 G 1	NRPE	2.4	16.0	380	0.78	∅
24 G 1	NRPE	2.4	17.1	437	1.28	∅
25 G 1	NRPE	2.4	17.1	497	1.36	218861

Con- struction	Core function	Core Ø	Outer Ø	Weight	Fire load	Order no.
n × mm ²			mm	kg / km	kWh / m	
27 G 1	NRPE	2.4	17.1	468	1.40	∅
30 G 1	NRPE	2.4	17.7	514	1.57	∅
33 G 1	NRPE	2.4	18.9	582	1.75	224020
37 G 1	NRPE	2.4	20.3	714	2.02	∅
1 × 1.5	L	3.0	4.3	32	0.07	∅
2 × 1.5	LN	3.0	7.6	89	0.25	211350
2 × 1.5	NR	3.0	7.6	89	0.25	217256
3 G 1.5	LNPE	3.0	8.1	106	0.26	211351
3 × 1.5	NR	3.0	8.1	106	0.26	217180
4 × 1.5	NR	3.0	8.8	129	0.31	215037
4 G 1.5	3LPE	3.0	8.8	129	0.31	222789
4 G 1.5	2LNPE	3.0	8.8	129	0.31	211352
5 G 1.5	3LNPE	3.0	9.8	161	0.40	222778
5 × 1.5	NR	3.0	9.8	161	0.40	221932
6 G 1.5	NRPE	3.0	10.9	190	0.48	211354
7 G 1.5	NRPE	3.0	12.0	228	0.53	211355
10 G 1.5	NRPE	3.0	14.6	322	0.64	211357
12 G 1.5	NRPE	3.0	14.6	316	0.65	211358
14 G 1.5	NRPE	3.0	15.4	366	0.74	∅
16 G 1.5	NRPE	3.0	16.2	415	0.84	211359
19 G 1.5	NRPE	3.0	18.3	486	0.99	∅
21 G 1.5	NRPE	3.0	19.7	562	1.18	214968
24 G 1.5	NRPE	3.0	21.1	644	1.39	220314
25 G 1.5	NRPE	3.0	21.1	731	1.38	212866
27 G 1.5	NRPE	3.0	21.1	693	1.36	217181
30 G 1.5	NRPE	3.0	21.8	760	1.48	∅
33 G 1.5	NRPE	3.0	22.6	831	1.62	∅
37 G 1.5	NRPE	3.0	24.8	1032	2.83	302217
1 × 2.5	L	3.7	5.0	45	0.10	∅
2 × 2.5	LN	3.7	9.0	129	0.34	211360
2 G 2.5	NR	3.7	9.0	129	0.34	216689
3 G 2.5	LNPE	3.7	9.8	160	0.37	211361
4 G 2.5	3LPE	3.7	10.8	197	0.46	222790
4 × 2.5	NR	3.7	10.8	247	0.58	218979
4 G 2.5	2LNPE	3.7	10.8	197	0.46	211362
5 G 2.5	3LNPE	3.7	12.0	247	0.58	222779
6 G 2.5	NRPE	3.7	13.2	288	0.62	∅
7 G 2.5	NRPE	3.7	14.6	346	0.76	211365
8 G 2.5	NRPE	3.7	15.7	379	0.80	216500
10 G 2.5	NRPE	3.7	17.7	482	0.89	∅
12 G 2.5	NRPE	3.7	17.7	483	0.89	211366
14 G 2.5	NRPE	3.7	19.0	572	1.09	301167
16 G 2.5	NRPE	3.7	20.1	651	1.25	∅
19 G 2.5	NRPE	3.7	20.7	765	1.48	∅
21 G 2.5	NRPE	3.7	22.7	857	1.49	∅
24 G 2.5	NRPE	3.7	25.8	984	2.21	∅
25 G 2.5	NRPE	3.7	25.8	1121	2.38	∅
27 G 2.5	NRPE	3.7	25.8	1069	1.94	∅
30 G 2.5	NRPE	3.7	26.7	1175	2.12	∅
33 G 2.5	NRPE	3.7	28.0	1301	2.35	∅
37 G 2.5	NRPE	3.7	30.6	1599	3.41	∅

Con- struction	Core function	Core Ø	Outer Ø	Weight	Fire load	Order no.
n × mm ²		mm	mm	kg/km	kWh/m	
1 × 4	L	4.2	5.6	62	0.12	Ø
2 × 4	LN	4.2	10.2	161	0.36	212870
2 × 4	NR	4.2	10.2	161	0.36	300782
3 G 4	LNPE	4.2	10.9	217	0.45	216165
4 G 4	3LPE	4.2	12.2	276	0.54	223188
5 G 4	3LNPE	4.2	13.5	340	0.66	222913
6 G 4	NRPE	4.2	14.9	398	0.75	Ø
7 G 4	NRPE	4.2	16.4	458	0.85	Ø
8 G 4	NRPE	4.2	17.6	523	0.96	Ø
10 G 4	NRPE	4.2	20.1	674	1.67	Ø
12 G 4	NRPE	4.2	20.1	688	1.10	302379
14 G 4	NRPE	4.2	21.5	805	1.29	302380
1 × 6	L	4.7	6.1	83	0.13	222433
2 × 6	LN	4.7	11.6	213	0.52	Ø
2 × 6	NR	4.7	11.6	213	0.52	301418
3 G 6	LNPE	4.7	12.4	279	0.56	219627
4 G 6	3LPE	4.7	13.8	341	0.56	222791
4 G 6	2LNPE	4.7	13.8	341	0.56	213672
4 × 6	NR	4.7	13.8	341	0.56	224652
5 G 6	3LNPE	4.7	15.4	431	0.75	222780
6 × 6	NR	4.7	16.7	519	0.83	219613
7 G 6	NRPE	4.7	18.3	616	1.00	214964
1 × 10	L	6.1	7.7	133	0.20	Ø
2 × 10	LN	6.1	14.7	355	0.68	Ø
3 × 10	NR	6.1	15.7	448	0.88	219628
4 G 10	3LPE	6.1	17.5	577	1.10	223189
4 G 10	2LNPE	6.1	17.5	577	1.10	214969
5 G 10	3LNPE	6.1	19.6	730	1.33	222912
6 G 10	NRPE	6.1	21.7	856	1.38	Ø
7 G 10	NRPE	6.1	23.7	1002	1.61	Ø
1 × 16	L	7.2	8.8	194	0.24	Ø
2 × 16	LN	7.2	17.1	489	0.87	213749
3 G 16	LNPE	7.2	19.7	757	1.04	Ø
4 G 16	3LPE	7.2	20.6	857	1.28	303609
4 G 16	2LNPE	7.2	20.6	857	1.28	214979
5 G 16	3LNPE	7.2	23.2	1084	1.64	223190
6 G 16	NRPE	7.2	25.6	1295	1.95	Ø
7 G 16	NRPE	7.2	28.3	1494	2.20	Ø

Con- struction	Core function	Core Ø	Outer Ø	Weight	Fire load	Order no.
n × mm ²		mm	mm	kg/km	kWh/m	
1 × 25	L	8.6	10.4	287	0.33	Ø
2 × 25	LN	8.6	20.4	730	1.24	Ø
3 × 25	NR	8.6	21.8	972	1.37	223541
4 G 25	3LPE	8.6	24.4	1281	1.78	303610
5 G 25	3LNPE	8.6	27.1	1584	2.16	Ø
6 G 25	NRPE	8.6	30.3	1917	2.65	Ø
7 G 25	NRPE	8.6	33.5	2205	2.95	Ø
1 × 35	L	10.1	12.1	405	0.53	Ø
2 × 35	LN	10.1	23.7	1008	1.63	223191
3 G 35	LNPE	10.1	25.5	1353	1.83	301141
4 G 35	NRPE	10.1	28.4	1767	2.29	301143
5 G 35	3LNPE	10.1	31.3	2186	2.77	301144
1 × 50	L	12.5	14.7	578	0.62	Ø
2 × 50	LN	12.5	28.9	1419	2.23	Ø
3 G 50	LNPE	12.5	31.1	1965	2.71	Ø
4 G 50	3LPE	12.5	34.9	2578	3.44	302205
5 G 50	3LNPE	12.5	38.7	3193	4.19	306276
1 × 70	L	14.0	16.4	777	0.74	Ø
2 × 70	LN	14.0	32.3	1889	2.73	Ø
3 G 70	LNPE	14.0	34.7	2629	3.29	Ø
4 G 70	3LPE	14.0	38.6	3429	4.08	Ø
5 G 70	3LNPE	14.0	43.1	4253	4.97	Ø
1 × 95	L	16.0	18.4	1010	0.88	308543
2 × 95	LN	16.0	36.7	2459	3.39	Ø
3 × 95	NRPE	16.0	39.2	3374	3.86	303871
4 G 95	3LPE	16.0	44.1	4492	5.11	303913
5 G 95	3LNPE	16.0	49.9	5648	6.52	306423

BETAflam® 145 flex UL/cUL AWM 4486, 125 °C 1000 V

Connection and power cable – temperature resistant

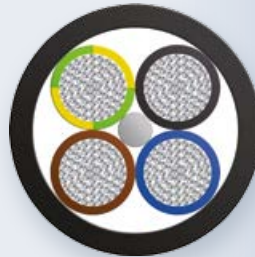
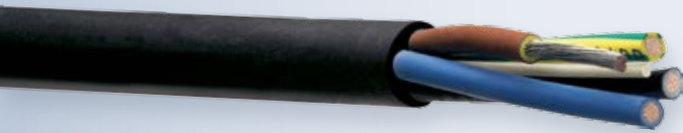

Competitive advantage

- Very high resistance to temperature, service temperature up to +145 °C
- Resistance to cold down to –55 °C
- Best fire performance, halogen free
- Good media resistance
- Electron-beam cross-linked
- Nominal voltage 1000 V

BETAflam® 145 flex UL/cUL

Application

Fixed and flexible application in dry, humid and wet rooms. Good weather, ozone and UV resistance. Extensively oil resistant. Intended for installation outdoors. Typical areas of application are connections of:

- Conveyor and assembly lines
- Conveying / production lines
- Power plants / switchgears

Construction

- Conductor Tinned fine copper strands acc. to VDE 0295/IEC 60228, class 5
- Insulation Polyolefine copolymer electron-beam cross-linked
- Core identification ≤ 5 cores acc. to HD 308 S2 (see page 70)
≥ 6 cores
 - black with white numbers or
 - black with white numbers and ●
- Outer sheath Polyolefine copolymer electron-beam cross-linked
- Colour of sheath ● black

Electrical properties

Nominal voltage	U ₀ /U	1000 V
Testing voltage		3500 V

Thermal properties

Conductor temperature	fixed installation	+145 °C max.
	occasionally moved	+120 °C max.
Short-circuit temperature		+280 °C max.
Ambient temperature	fixed installation	–55 °C min.
	occasionally moved	–35 °C min.

Bending radius

For fixed installation	> 4 × outer Ø
Occasionally moved	> 8 × outer Ø

Standards / material properties

- Halogen free: IEC 60754-1, EN 50267-2-1
- No corrosive gases: IEC 60754-2, EN 50267-2-2
- No toxic gases: NF X 70-100
- Low smoke density: IEC 61034
- Flame retardant: EN/IEC 60332-1-2, FT 1, FT 2
- Non-flame propagating: IEC 60332-3, NF C 32-070
- Low fire load: DIN 51900

Approvals

- UL AWM Style 4486, 125 °C 1000 V, file no. E146164
- cUL AWM I/II AB, 125 °C 1000 V (cUL is equivalent to approbation according to CSA)
- Germanischer Lloyd (GL) certificate no. 96627-94HH
- Lloyd's Register (LR) certificate no. 03/20057
- BUREAU VERITAS (BV) certificate no. 13348/B1 BV
- DET Norske Veritas (DNV) *
- CHINA CLASSIFICATION SOCIETY (CCS) certificate no. HB11 W00001T_02

Special features

Special types upon request

* only valid for cross-section range 0.5-4 mm²

Con- struction	Core function	Core Ø	Outer Ø	Weight	Fire load	Order no.
n×mm ²			mm	kg/km	kWh/m	
2×0.5	LN	1.9	5.8	43	0.12	Ø
3G0.5	LNPE	1.9	6.1	51	0.14	Ø
4G0.5	NRPE	1.9	6.5	60	0.15	Ø
4×0.5	NR	1.9	6.5	60	0.15	Ø
5G0.5	3LNPE	1.9	7.2	73	0.20	Ø
6G0.5	NRPE	1.9	7.6	82	0.22	Ø
7G0.5	NRPE	1.9	8.2	97	0.27	Ø
8G0.5	NRPE	1.9	9.0	107	0.31	Ø
10G0.5	NRPE	1.9	9.8	135	0.33	Ø
12G0.5	NRPE	1.9	9.8	130	0.33	Ø
14G0.5	NRPE	1.9	10.2	148	0.34	Ø
16G0.5	NRPE	1.9	10.9	169	0.39	Ø
2×0.75	LN	2.2	6.5	57	0.16	Ø
2×0.75	NR	2.2	6.5	57	0.16	Ø
3G0.75	LNPE	2.2	6.8	66	0.18	308568
3×0.75	NR	2.2	6.8	66	0.18	Ø
4×0.75	NR	2.2	7.4	80	0.20	308569
4G0.75	3LPE	2.2	7.4	80	0.20	308570
5G0.75	3LNPE	2.2	8.1	99	0.26	308571
5×0.75	NR	2.2	8.1	99	0.26	Ø
6G0.75	NR	2.2	8.7	112	0.29	Ø
6G0.75	NRPE	2.2	8.7	112	0.29	Ø
7G0.75	NRPE	2.2	9.5	132	0.36	Ø
8G0.75	NRPE	2.2	10.4	146	0.36	Ø
10G0.75	NR	2.2	11.2	187	0.75	Ø
10G0.75	NRPE	2.2	11.2	187	0.75	Ø
12G0.75	NRPE	2.2	11.2	179	0.38	Ø
14G0.75	NRPE	2.2	11.7	203	0.43	Ø
16G0.75	NRPE	2.2	12.5	233	0.51	Ø
1×1	L	2.4	4.4	28	0.07	Ø
2×1	LN	2.4	6.9	52	0.13	308572
2×1	NR	2.4	6.9	52	0.13	Ø
3G1	LNPE	2.4	7.3	66	0.16	308573
3×1	NR	2.4	7.3	66	0.16	Ø
4×1	NR	2.4	7.9	87	0.20	Ø
4×1	NRPE	2.4	7.9	87	0.20	Ø
5G1	3LNPE	2.4	8.7	109	0.26	308574
5×1	NR	2.4	8.7	109	0.26	Ø
6G1	NRPE	2.4	8.9	124	0.30	Ø
7G1	NRPE	2.4	10.1	153	0.40	308575
8G1	NRPE	2.4	11.1	178	0.41	Ø
10G1	NRPE	2.4	12.1	222	0.47	Ø
12G1	NRPE	2.4	12.1	221	0.46	Ø
14G1	NRPE	2.4	12.7	252	0.50	Ø
16G1	NRPE	2.4	13.6	290	0.59	Ø
19G1	NRPE	2.4	15.1	338	0.74	Ø
21G1	NRPE	2.4	16.0	380	0.78	Ø
24G1	NRPE	2.4	17.1	437	1.28	Ø
25G1	NRPE	2.4	17.1	497	1.36	Ø
27G1	NRPE	2.4	17.1	468	1.40	Ø

Con- struction	Core function	Core Ø	Outer Ø	Weight	Fire load	Order no.
n×mm ²			mm	kg/km	kWh/m	
30G1	NRPE	2.4	17.7	514	1.57	Ø
33G1	NRPE	2.4	18.9	582	1.75	Ø
37G1	NRPE	2.4	20.3	714	2.02	Ø
1×1.5	L	3.0	5.0	37	0.08	Ø
2×1.5	LN	3.0	8.0	93	0.26	Ø
2×1.5	NR	3.0	8.0	93	0.26	Ø
3G1.5	LNPE	3.0	8.5	111	0.27	308576
3×1.5	NR	3.0	8.5	111	0.27	Ø
4×1.5	NR	3.0	9.2	134	0.32	308577
4G1.5	3LPE	3.0	9.2	134	0.32	308578
5G1.5	3LNPE	3.0	10.0	164	0.41	308579
5×1.5	NR	3.0	10.0	164	0.41	Ø
6G1.5	NRPE	3.0	10.9	190	0.48	Ø
7G1.5	NRPE	3.0	12.0	228	0.53	308580
10G1.5	NRPE	3.0	14.6	322	0.64	Ø
12G1.5	NRPE	3.0	14.6	316	0.65	308581
14G1.5	NRPE	3.0	15.4	366	0.74	Ø
16G1.5	NRPE	3.0	16.2	415	0.84	Ø
19G1.5	NRPE	3.0	18.3	486	0.99	Ø
21G1.5	NRPE	3.0	19.7	562	1.18	Ø
24G1.5	NRPE	3.0	21.1	644	1.39	Ø
25G1.5	NRPE	3.0	21.1	731	1.38	Ø
27G1.5	NRPE	3.0	21.1	693	1.36	Ø
30G1.5	NRPE	3.0	21.8	760	1.48	Ø
33G1.5	NRPE	3.0	22.6	831	1.62	Ø
37G1.5	NRPE	3.0	24.8	1032	2.83	Ø
1×2.5	L	3.7	5.7	50	0.11	Ø
2×2.5	LN	3.7	9.4	134	0.35	308582
2G2.5	NR	3.7	9.4	134	0.35	Ø
3G2.5	LNPE	3.7	10.0	163	0.38	308583
4G2.5	3LPE	3.7	11.0	199	0.47	308584
4×2.5	NR	3.7	11.0	199	0.59	Ø
5G2.5	3LNPE	3.7	12.0	247	0.58	308586
6G2.5	NRPE	3.7	13.2	288	0.62	Ø
7G2.5	NRPE	3.7	14.6	346	0.76	308587
8G2.5	NRPE	3.7	15.7	379	0.80	Ø
10G2.5	NRPE	3.7	17.7	482	0.89	Ø
12G2.5	NRPE	3.7	17.7	483	0.89	Ø
14G2.5	NRPE	3.7	19.0	572	1.09	Ø
16G2.5	NRPE	3.7	20.1	651	1.25	Ø
19G2.5	NRPE	3.7	20.7	765	1.48	Ø
21G2.5	NRPE	3.7	22.7	857	1.49	Ø
24G2.5	NRPE	3.7	25.8	984	2.21	Ø
25G2.5	NRPE	3.7	25.8	1121	2.38	Ø
27G2.5	NRPE	3.7	25.8	1069	1.94	Ø
30G2.5	NRPE	3.7	26.7	1175	2.12	Ø
33G2.5	NRPE	3.7	28.0	1301	2.35	Ø
37G2.5	NRPE	3.7	30.6	1599	3.41	Ø
1×4	L	4.2	6.2	62	0.13	Ø
2×4	LN	4.2	10.4	164	0.36	Ø
2×4	NR	4.2	10.4	164	0.44	Ø

Con- struction	Core function	Core Ø	Outer Ø	Weight	Fire load	Order no.
n × mm ²			mm	kg/km	kWh/m	
3 G4	LNPE	4.2	11.0	219	0.46	Ø
4 G4	3LPE	4.2	12.2	276	0.56	308588
5 G4	3LNPE	4.2	13.5	340	0.71	308589
6 G4	NRPE	4.2	14.9	398	0.75	Ø
7 G4	NRPE	4.2	16.4	458	0.85	Ø
8 G4	NRPE	4.2	17.6	523	0.96	Ø
10 G4	NRPE	4.2	20.1	674	1.67	Ø
12 G4	NRPE	4.2	20.1	688	1.10	Ø
14 G4	NRPE	4.2	21.5	805	1.29	Ø
1 × 6	L	5.0	7.0	95	0.14	Ø
2 × 6	LN	5.0	12.3	225	0.55	Ø
2 × 6	NR	5.0	12.3	225	0.55	Ø
3 G6	LNPE	5.0	13.1	294	0.59	Ø
4 G6	3LPE	5.0	14.7	363	0.59	Ø
4 G6	2LNPE	5.0	14.7	363	0.59	Ø
4 × 6	NR	5.0	14.7	363	0.59	Ø
5 G6	3LNPE	5.0	16.2	453	0.78	Ø
6 × 6	NR	5.0	17.6	546	0.87	Ø
7 G6	NRPE	5.0	19.7	663	1.07	Ø
1 × 10	L	6.9	8.9	157	0.23	Ø
2 × 10	LN	6.9	16.1	384	0.74	Ø
3 × 10	NR	6.9	17.5	509	0.98	Ø
4 G10	3LPE	6.9	19.9	670	1.25	Ø
4 G10	2LNPE	6.9	19.9	670	1.25	Ø
5 G10	3LNPE	6.9	22.0	1001	1.49	Ø
7 G10	NRPE	6.9	26.6	1149	1.61	Ø
1 × 16	L	8.3	10.3	230	0.30	Ø
2 × 16	LN	8.3	19.7	589	1.08	Ø
3 G16	LNPE	8.3	21.3	780	1.45	Ø
4 G16	3LPE	8.3	23.7	1002	1.84	Ø
4 G16	2LNPE	8.3	23.7	1002	1.84	Ø
5 G16	3LNPE	8.3	26.3	1263	2.18	Ø
1 × 25	L	9.4	11.4	322	0.42	Ø
2 × 25	LN	9.4	22.1	821	1.48	Ø
3 × 25	NR	9.4	23.8	1020	1.42	Ø
4 G25	3LPE	9.4	26.4	1350	1.87	Ø
5 G25	3LNPE	9.4	29.2	1693	2.34	Ø
1 × 35	L	10.5	12.5	427	0.48	Ø
2 × 35	LN	10.5	24.5	1085	1.79	Ø
3 G35	LNPE	10.5	26.4	1371	1.74	Ø
4 G35	NRPE	10.5	29.4	1808	2.24	Ø
5 G35	3LNPE	10.5	32.6	2263	2.77	Ø

Con- struction	Core function	Core Ø	Outer Ø	Weight	Fire load	Order no.
n × mm ²			mm	kg/km	kWh/m	
1 × 50	L	13.2	15.2	600	0.62	Ø
2 × 50	LN	13.2	30.5	1531	2.38	Ø
3 G50	LNPE	13.2	32.8	1971	2.37	Ø
4 G50	3LPE	13.2	36.7	2613	3.10	Ø
5 G50	3LNPE	13.2	40.9	3277	3.85	Ø
1 × 70	L	15.2	17.6	823	0.77	Ø
2 × 70	LN	15.2	34.5	2229	2.96	Ø
3 G70	LNPE	15.2	37.5	2663	2.99	Ø
4 G70	3LPE	15.2	42.4	3565	3.83	Ø
5 G70	3LNPE	15.2	47.0	4470	4.76	Ø
1 × 95	L	16.5	19.2	1054	0.96	Ø
2 × 95	LN	16.5	37.5	2565	3.57	Ø
3 × 95	NRPE	16.5	40.2	3342	3.43	Ø
4 G95	3LPE	16.5	45.6	4480	4.62	Ø
5 G95	3LNPE	16.5	51.0	5635	5.88	Ø

BETAtrans® GKW flex R 600/1000 V

Control cable – temperature-resistant, with reduced wall thickness



Competitive advantage

- Volume and weight optimised
- Very high resistance to temperature, service temperature up to +120 °C
- Resistance to cold up to –50 °C
- Best fire performance, halogen free
- Resistance to oil and fuel
- Electron-beam cross-linked

BETAflam® GKW flex R

Application

For protected installation within and outside of rolling stock and buses. These cables with very small outer diameter are used wherever space is very limited.

Construction

- Conductor Tinned fine copper strands acc. to VDE 0295/IEC 60228, class 5
- Insulation Polyolefine copolymer electron-beam cross-linked
- Core identification ○ white with black
- Outer sheath Electron-beam cross-linked elastomer
- Colour of sheath ● black

Electrical properties

Nominal voltage		
With fixed and protected installation	U_0/U	600/1000 V
Testing voltage		3500 V

Thermal properties

Conductor temperature	fixed installation	+120 °C max.
Short-circuit temperature		+280 °C max.
Ambient temperature	fixed installation	–50 °C min.

Bending radius

For fixed installation	> 4 × outer Ø
------------------------	---------------

Standards / material properties

- Halogen free: EN 50267-2-1, IEC 60754-1
- No corrosive gases: EN 50267-2-2, IEC 60754-2
- No toxic gases: NF X 70-100
- Low smoke density: IEC 61034
- Flame retardant: EN 50265-2-1, IEC 60332-1
- Non-flame propagating: IEC 60332-3, NF C 32-070
- Low fire load: DIN 51900
- Resistance to oil and fuel: EN 50306-4, EN 60811-2-1

Approvals

- Gost R

Special features

Special types upon request

Con- struction	Core function	Core Ø	Outer Ø	Weight	Fire load	Order no.
n × mm ²			mm	kg / km	kWh / m	
2 × 0.5	NR	1.45	4.3	29	0.08	223370
3 × 0.5	NR	1.45	4.5	35	0.08	223371
4 × 0.5	NR	1.45	4.9	43	0.09	224427
5 × 0.5	NR	1.45	5.3	51	0.11	224428
6 × 0.5	NR	1.45	5.8	58	0.14	224429
7 × 0.5	NR	1.45	6.6	70	0.15	224430
8 × 0.5	NR	1.45	6.7	81	0.18	224443
10 × 0.5	NR	1.45	6.8	87	0.17	303311
12 × 0.5	NR	1.45	7.2	101	0.19	∅
14 × 0.5	NR	1.45	7.6	114	0.21	∅
16 × 0.5	NR	1.45	8.0	129	0.24	∅
19 × 0.5	NR	1.45	9.0	155	0.26	∅
24 × 0.5	NR	1.45	9.8	180	0.31	224566
2 × 0.75	NR	1.7	4.8	38	0.09	223372
3 × 0.75	NR	1.7	5.1	47	0.10	223373
4 × 0.75	NR	1.7	5.5	57	0.12	223791
5 × 0.75	NR	1.7	6.0	68	0.14	223792
6 × 0.75	NR	1.7	6.6	83	0.17	224431
7 × 0.75	NR	1.7	7.3	92	0.18	224432
8 × 0.75	NR	1.7	7.6	109	0.22	224433
10 × 0.75	NR	1.7	7.8	119	0.21	∅
12 × 0.75	NR	1.7	8.3	138	0.24	∅
14 × 0.75	NR	1.7	8.7	157	0.27	∅
16 × 0.75	NR	1.7	9.2	177	0.30	224434
19 × 0.75	NR	1.7	10.2	212	0.32	∅
24 × 0.75	NR	1.7	11.3	249	0.38	∅
2 × 1	NR	1.9	5.2	47	0.10	223374
3 × 1	NR	1.9	5.5	58	0.12	223375
4 × 1	NR	1.9	6.1	72	0.14	223527
5 × 1	NR	1.9	6.6	86	0.17	223585
6 × 1	NR	1.9	7.2	104	0.20	307163
7 × 1	NR	1.9	8.1	117	0.21	∅
8 × 1	NR	1.9	8.3	137	0.26	∅

Con- struction	Core function	Core Ø	Outer Ø	Weight	Fire load	Order no.
n × mm ²			mm	kg / km	kWh / m	
10 × 1	NR	1.9	8.6	152	0.26	∅
12 × 1	NR	1.9	9.1	176	0.29	244435
14 × 1	NR	1.9	9.7	202	0.33	∅
16 × 1	NR	1.9	10.2	228	0.37	∅
19 × 1	NR	1.9	11.4	273	0.40	∅
24 × 1	NR	1.9	12.5	320	0.46	∅
2 × 1.5	NR	2.3	6.0	63	0.14	223376
3 × 1.5	NR	2.3	6.4	79	0.15	223377
4 × 1.5	NR	2.3	7.0	99	0.19	224436
5 × 1.5	NR	2.3	7.6	120	0.21	224437
6 × 1.5	NR	2.3	8.4	144	0.26	224438
7 × 1.5	NR	2.3	9.3	160	0.28	224439
8 × 1.5	NR	2.3	9.7	192	0.35	224440
10 × 1.5	NR	2.3	10.2	214	0.34	224441
12 × 1.5	NR	2.3	10.8	249	0.39	224442
14 × 1.5	NR	2.3	11.4	285	0.44	∅
16 × 1.5	NR	2.3	12.0	323	0.49	223528
19 × 1.5	NR	2.3	13.3	385	0.53	∅
24 × 1.5	NR	2.3	14.9	454	0.62	∅
2 × 2.5	NR	2.8	7.0	92	0.18	223378
3 × 2.5	NR	2.8	7.4	116	0.19	223379
4 × 2.5	NR	2.8	8.2	147	0.24	∅
5 × 2.5	NR	2.8	9.0	181	0.28	∅
6 × 2.5	NR	2.8	9.8	215	0.33	∅
7 × 2.5	NR	2.8	11.0	243	0.36	∅
8 × 2.5	NR	2.8	11.6	293	0.47	∅
10 × 2.5	NR	2.8	12.2	328	0.44	∅
12 × 2.5	NR	2.8	12.8	382	0.49	∅
14 × 2.5	NR	2.8	13.6	438	0.55	∅
16 × 2.5	NR	2.8	14.4	495	0.61	∅
19 × 2.5	NR	2.8	16.1	596	0.70	∅
24 × 2.5	NR	2.8	17.9	706	0.78	∅

BETAflam® CHEMA C-flex 600/1000 V

Shielded motor connection cable – oil and chemical resistant

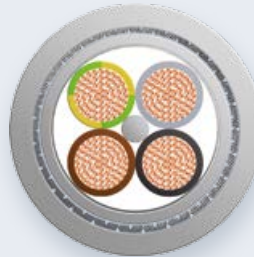

Competitive advantage

- Oil and chemical resistant
- Best fire performance, halogen free
- High temperature resistance 90 °C (fixed installation)
- Good stress crack resistance
- EMC-optimised braided shield

BETAflam® CHEMA C-flex

Application

Fixed and flexible application for average mechanical stress in dry, humid and wet rooms.

Only outdoors in observance of the temperature range; do not install without UV protection and not in the ground.

This conductor is specially designed for the electrical supply between frequency converters and servo motors in industrial applications

Construction

- Conductor Bare fine copper strands acc. to VDE 0295/IEC 60228, class 5
- Insulation Polyolefine copolymer
- Core identification acc. to HD 308 S2 (see page 70)
3LPE 4 × = ● ● ● ●
2LNPE 4 × = ● ● ● ●
- Inner sheath Polyolefine copolymer
- Shield Tinned fine copper braid
- Dual layer outer sheath Inside: Polyolefine copolymer
Outside: TPE-V
- Colour of sheath ● Grey

Electrical properties

Nominal voltage

With fixed and protected installation U_0/U 600/1000 V

Testing voltage Conductor / Conductor 3500 V
Conductor / Shielding 2500 V

Thermal properties

Conductor temperature fixed installation +90 °C max.
occasionally moved +80 °C max.

Short-circuit temperature +160 °C max.

Ambient temperature fixed installation -40 °C min.
occasionally moved -25 °C min.

Bending radius

For fixed installation $> 4 \times \text{outer } \varnothing$
Occasionally moved $> 12 \times \text{outer } \varnothing$

Standards / material properties

- Halogen free: IEC 60754-1, EN 50267-2-1
- No corrosive gases: IEC 60754-2, EN 50267-2-2
- No toxic gases: NF X 70-100
- Oil resistance: EN 60811-2-1 (24 h / 70 °C)
- Chemical resistance: See table on page 76
- Low smoke density: IEC 61034, DIN EN 61034-2, EN 50268-2
- Flame retardant: EN/IEC 60332-1-2
- Non-flame propagating: IEC 60332-3, DIN EN 60332-3, EN 50266-2
- Low fire load: DIN 51900

Approvals

- Gost R

Special features

Special types upon request

Con- struction n × mm ²	Core function	Core Ø	Outer Ø	Weight kg / km	Fire load kWh / m	Order no.
4G 1.5	2LNPE	3.0	11.2	196	0.47	223754
4G 2.5	2LNPE	3.7	13.6	285	0.68	223755
4G 2.5	3LPE	3.7	13.6	285	0.68	223746
4G 4	3LPE	4.2	15.2	376	0.81	223747
4G 6	3LPE	4.8	17.1	515	0.96	223748
4G 10	3LPE	6.3	22.1	823	1.64	223749
4G 16	3LPE	7.8	26.5	1183	2.21	223750
4G 25	3LPE	9.2	31.0	1815	3.24	223751
4G 35	3LPE	10.4	34.3	2299	3.86	∅
4G 50	3LPE	12.2	39.6	3168	5.17	223752
4G 70	3LPE	14.2	45.7	4282	6.84	∅
4G 95	3LPE	16.4	51.2	5430	8.26	223753

BETAflam® CHEMA C-flex DR 300/500 V

Shielded connection cable – flexible, with reduced wall thickness, oil and chemical resistant

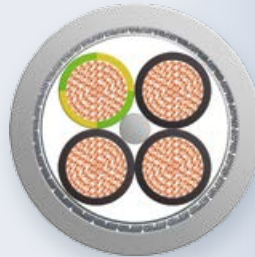

Competitive advantage

- Volume and weight optimised
- Oil and chemical resistant
- Best fire performance, halogen free
- High temperature resistance 90 °C (fixed installation)
- Good stress crack resistance
- EMC-optimised braided shield

BETAflam® CHEMA C-flex DR

Application

Fixed and flexible application for average mechanical stress in dry, humid and wet rooms, especially under industrial ambient conditions.

Only outdoors in observance of the temperature range; do not install without UV protection and not in the ground.

Typical applications are:

- Conveying and automation systems
- Chemical industry / food industry
- Washing systems
- Paper industry
- Cheese dairies / butcheries
- Automotive manufacturers, etc.

Resistant to conventional cold cleaners and disinfectants in public buildings, commercial buildings and industry.

Construction

- | | |
|---------------------------|---|
| ■ Conductor | Bare fine copper strands
acc. to VDE 0295/IEC 60228, class 5 |
| ■ Insulation | Polyolefine copolymer |
| ■ Core identification | ● black with white numbers or
● black with white numbers and ● |
| ■ Shield | Tinned fine copper braid |
| ■ Dual layer outer sheath | Inside: Polyolefine copolymer
Outside: TPE-V |
| ■ Colour of sheath | ● Grey |

Electrical properties

Nominal voltage	U ₀ /U	300 / 500 V
Testing voltage	Conductor / Conductor	3500 V
	Conductor / Shielding	2500 V

Thermal properties

Conductor temperature	fixed installation	+90 °C max.
	occasionally moved	+80 °C max.
Short-circuit temperature		+160 °C max.
Ambient temperature	fixed installation	-40 °C min.
	occasionally moved	-25 °C min.

Bending radius

For fixed installation	> 4 × outer Ø
Occasionally moved	> 12 × outer Ø

Standards / material properties

- Halogen free: IEC 60754-1, EN 50267-2-1
- No corrosive gases: IEC 60754-2, EN 50267-2-2
- No toxic gases: NF X 70-100
- Oil resistance: EN 60811-2-1 (24 h / 70 °C)
- Chemical resistance: See table on page 76
- Low smoke density: IEC 61034, DIN EN 61034-2, EN 50268-2
- Flame retardant: EN/IEC 60332-1-2
- Non-flame propagating: IEC 60332-3, DIN EN 60332-3, EN 50266-2
- Low fire load: DIN 51900

Approvals

- Gost R

Special features

Special types upon request

Con- struction	Core function	Core Ø	Outer Ø	Weight	Fire load	Order no.
n × mm ²		mm	mm	kg/km	kWh/m	
2 × 0.5	NR	1.8	5.6	44	0.14	Ø
3 G 0.5	NRPE	1.8	6.1	58	0.14	Ø
4 G 0.5	NRPE	1.8	6.5	69	0.16	Ø
5 G 0.5	NRPE	1.8	7.0	83	0.18	Ø
7 G 0.5	NRPE	1.8	8.2	114	0.25	Ø
12 G 0.5	NRPE	1.8	9.4	152	0.29	Ø
18 G 0.5	NRPE	1.8	11.3	223	0.45	Ø
2 × 0.75	NR	2.0	6.3	60	0.16	Ø
3 G 0.75	NRPE	2.0	6.6	71	0.16	305115
4 G 0.75	NRPE	2.0	7.2	87	0.18	Ø
4 × 0.75	NR	2.0	7.2	87	0.18	305116
5 G 0.75	NRPE	2.0	7.7	102	0.21	305117
7 G 0.75	NRPE	2.0	8.9	140	0.28	305118
12 G 0.75	NRPE	2.0	10.8	205	0.38	305119
18 G 0.75	NRPE	2.0	12.5	288	0.52	Ø
25 G 0.75	NRPE	2.0	14.6	384	0.67	Ø
2 × 1	NR	2.1	6.5	68	0.17	305122
3 G 1	NRPE	2.1	6.8	80	0.17	305123
4 G 1	NRPE	2.1	7.4	98	0.19	305124
5 G 1	NRPE	2.1	8.1	120	0.23	305125
7 G 1	NRPE	2.1	9.3	162	0.30	Ø
10 G 1	NRPE	2.1	10.7	209	0.37	Ø
12 G 1	NRPE	2.1	11.2	239	0.41	305127
18 G 1	NRPE	2.1	13.1	340	0.55	Ø
25 G 1	NRPE	2.1	15.6	467	0.78	Ø

Con- struction	Core function	Core Ø	Outer Ø	Weight	Fire load	Order no.
n × mm ²		mm	mm	kg/km	kWh/m	
2 × 1.5	NR	2.4	7.1	84	0.18	305129
3 G 1.5	NRPE	2.4	7.5	97	0.18	305130
4 G 1.5	NRPE	2.4	8.1	122	0.21	305131
5 G 1.5	NRPE	2.4	8.9	146	0.25	305132
7 G 1.5	NRPE	2.4	10.7	210	0.39	305133
10 G 1.5	NRPE	2.4	11.9	262	0.42	Ø
12 G 1.5	NRPE	2.4	12.5	298	0.46	305135
18 G 1.5	NRPE	2.4	14.5	424	0.63	Ø
25 G 1.5	NRPE	2.4	18.3	635	1.0	Ø
2 × 2.5	NR	3.1	8.5	121	0.24	Ø
3 G 2.5	NRPE	3.1	9.0	142	0.24	305138
4 G 2.5	NRPE	3.1	10.3	188	0.34	305139
5 G 2.5	NRPE	3.1	11.1	227	0.39	305140
7 G 2.5	NRPE	3.1	12.9	314	0.55	Ø
12 G 2.5	NRPE	3.1	15.8	471	0.72	Ø
2 × 4	NR	3.6	9.5	173	0.34	Ø
3 G 4	NRPE	3.6	10.5	207	0.32	Ø
4 G 4	NRPE	3.6	11.5	262	0.40	305142
5 G 4	NRPE	3.6	12.5	317	0.47	305143
7 G 4	NRPE	3.6	14.6	461	0.74	Ø
2 × 6	NR	4.4	11.5	232	0.41	Ø
3 G 6	NRPE	4.4	12.2	285	0.41	Ø
4 G 6	NRPE	4.4	13.3	362	0.48	Ø
5 G 6	NRPE	4.4	14.7	447	0.59	305144
7 G 6	NRPE	4.4	18.5	693	1.0	Ø

BETAflam® 145 C-flex 600/1000 V

Shielded connection and power cable – temperature resistant



Competitive advantage

- Very high resistance to temperature, service temperature up to +145 °C
- Resistance to cold up to –55 °C
- Best fire performance, halogen free
- EMC-optimised braided shield
- Good media resistance
- Electron-beam cross-linked

BETAflam® 145 C-flex

Application

Fixed and flexible application in dry, humid and wet rooms. Good weather, ozone and UV resistance. Extensively oil resistant. Intended for installation outdoors. Typical areas of application are connections of:

- Lamps
- Heating units
- Electrical machinery (thermal class B)
- Switchboards / switch cabinets and distributors in apparatus, mechanical or plant engineering

Construction

- Conductor Tinned fine copper strands acc. to VDE 0295/IEC 60228, class 5
- Insulation Polyolefine copolymer electron-beam cross-linked
- Core identification ● black with white numbers
- Shield Tinned fine copper braid
- Colour of sheath ● black

Electrical properties

Nominal voltage	$U_0/U \leq 1 \text{ mm}^2$	300/500 V
	$U_0/U \geq 1.5 \text{ mm}^2$	450/750 V
With fixed and protected installation	$U_0/U \geq 1.5 \text{ mm}^2$	600/1000 V
Testing voltage	Conductor / Conductor	3500 V
	Conductor / Shielding	2500 V

Thermal properties

Conductor temperature	fixed installation	+145 °C max.
	occasionally moved	+120 °C max.
Short-circuit temperature		+280 °C max.
Ambient temperature	fixed installation	–55 °C min.
	occasionally moved	–35 °C min.

Bending radius

For fixed installation	$> 4 \times \text{outer } \varnothing$
Occasionally moved	$> 8 \times \text{outer } \varnothing$

Standards / material properties

- Halogen free: IEC 60754-1, EN 50267-2-1
- No corrosive gases: IEC 60754-2, EN 50267-2-2
- No toxic gases: NF X 70-100
- Low smoke density: IEC 61034, DIN EN 61034-2, EN 50268-2
- Flame retardant: EN/IEC 60332-1-2
- Non-flame propagating: IEC 60332-3, DIN EN 60332-3, EN 50266-2, NF C 32-070
- Low fire load: DIN 51900

Approvals

- Germanischer Lloyd (GL) certificate no. 96627-94HH
- Lloyd's Register (LR) certificate no. 03/20057
- BUREAU VERITAS (BV) certificate no. 13348/B1 BV
- DET Norske Veritas (DNV) certificate no. E-8949/8951
- CHINA CLASSIFICATION SOCIETY (CCS) certificate no. HB11W00001_02
- Gost R

Special features

Special types upon request

Con- struction	Core function	Core Ø	Outer Ø	Weight	Fire load	Order no.
n×mm ²		mm	mm	kg/km	kWh/m	
2×0.5	NR	1.9	5.6	45	0.11	217371
3×0.5	NR	1.9	6.1	59	0.11	∅
4×0.5	NR	1.9	6.7	72	0.14	221012
5×0.5	NR	1.9	7.3	86	0.17	∅
6×0.5	NR	1.9	7.9	102	0.20	∅
7×0.5	NR	1.9	8.4	118	0.23	∅
8×0.5	NR	1.9	9.0	133	0.26	∅
10×0.5	NR	1.9	10.0	157	0.31	∅
12×0.5	NR	1.9	10.0	164	0.30	∅
1×0.75	L	2.2	4.0	28	0.06	∅
2×0.75	LN	2.2	6.6	66	0.15	217638
2×0.75	NR	2.2	6.6	66	0.15	211367
3×0.75	NR	2.2	6.9	78	0.15	211368
3G0.75	NRPE	2.2	6.9	78	0.15	304100
4×0.75	NR	2.2	7.6	94	0.17	211369
4G0.75	NRPE	2.2	7.6	94	0.17	304645
5×0.75	NR	2.2	8.3	113	0.22	211370
5G0.75	NRPE	2.2	8.3	113	0.22	304101
6×0.75	NR	2.2	8.9	132	0.24	211371
7×0.75	NR	2.2	9.9	158	0.31	211372
7G0.75	NRPE	2.2	9.9	158	0.31	304102
8×0.75	NR	2.2	10.6	181	0.36	∅
10×0.75	NR	2.2	11.5	209	0.41	218891
12×0.75	NR	2.2	11.5	219	0.40	214971
14×0.75	NR	2.2	12.2	251	0.46	∅
16×0.75	NR	2.2	12.9	279	0.52	218512
19×0.75	NR	2.2	14.5	347	0.66	304932
21×0.75	NR	2.2	15.3	385	0.74	∅
1×1	L	2.4	4.2	33	0.07	∅
2×1	NR	2.4	7.0	79	0.16	212661
3×1	NR	2.4	7.4	89	0.17	218841
3G1	NRPE	2.4	7.4	89	0.17	300812
4×1	NR	2.4	8.1	113	0.20	221126
4G1	NRPE	2.4	8.1	113	0.20	218185
5×1	NR	2.4	8.9	134	0.25	218790
5G1	NRPE	2.4	8.9	134	0.25	218852
6×1	NR	2.4	9.5	156	0.30	225248
7×1	NR	2.4	10.5	187	0.40	218786
7G1	NRPE	2.4	10.5	187	0.40	218868
8×1	NR	2.4	11.4	218	0.41	∅
10×1	NR	2.4	12.5	253	0.48	∅
12×1	NR	2.4	12.5	266	0.47	224022
1×1.5	L	3.0	4.8	43	0.09	∅
2×1.5	NR	3.0	8.2	105	0.22	211373
3×1.5	NR	3.0	8.7	119	0.22	211374
3G1.5	NRPE	3.0	8.7	119	0.22	221809
4×1.5	NR	3.0	9.4	146	0.23	211375
4G1.5	2LNPE	3.0	9.4	146	0.23	213934
4G1.5	NRPE	3.0	9.4	146	0.23	219673
5×1.5	NR	3.0	10.5	183	0.31	211376
5G1.5	NRPE	3.0	10.5	183	0.31	221047

Con- struction	Core function	Core Ø	Outer Ø	Weight	Fire load	Order no.
n×mm ²		mm	mm	kg/km	kWh/m	
6×1.5	NR	3.0	11.5	219	0.42	∅
7×1.5	NR	3.0	12.6	260	0.50	211378
7G1.5	NRPE	3.0	12.6	260	0.50	214030
8×1.5	NR	3.0	13.7	305	0.60	304226
10×1.5	NR	3.0	15.0	309	0.60	∅
12×1.5	NR	3.0	15.0	371	0.64	222149
14×1.5	NR	3.0	16.0	455	0.75	216957
16×1.5	NR	3.0	17.0	502	0.85	∅
19×1.5	NR	3.0	19.3	627	1.15	226401
21×1.5	NR	3.0	20.3	698	1.28	215657
25G1.5	NRPE	3.0	21.7	737	1.33	214031
1×2.5	L	3.7	5.6	61	0.11	∅
2×2.5	NR	3.7	9.8	148	0.32	211379
3×2.5	NR	3.7	10.4	171	0.33	211380
3G2.5	LNPE	3.7	10.4	171	0.33	217068
3G2.5	NRPE	3.7	10.4	171	0.29	218770
4×2.5	NR	3.7	11.5	216	0.38	211381
4G2.5	2LNPE	3.7	11.5	216	0.38	214028
4G2.5	NRPE	3.7	11.5	216	0.38	225386
5×2.5	NR	3.7	12.6	267	0.46	211382
5G2.5	NRPE	3.7	12.6	267	0.46	221810
6×2.5	NR	3.7	13.8	321	0.57	∅
7G2.5	NRPE	3.7	15.3	385	0.72	217278
8×2.5	NR	3.7	16.5	461	0.84	∅
10×2.5	NR	3.7	18.3	534	0.93	∅
12×2.5	NR	3.7	18.3	569	0.90	304333
14×2.5	NR	3.7	19.6	664	1.10	∅
16×2.5	NR	3.7	20.7	753	1.23	∅
19×2.5	NR	3.7	23.5	934	1.65	226045
21×2.5	NR	3.7	24.4	1022	1.80	304334
1×4	L	4.2	6.3	84	0.12	∅
2×4	NR	4.2	10.9	174	0.34	217057
3×4	NR	4.2	11.5	226	0.34	∅
3G4	NRPE	4.2	11.5	226	0.34	226254
4×4	NR	4.2	12.8	290	0.44	214029
5G4	NRPE	4.2	14.2	362	0.57	221811
6×4	NR	4.2	15.6	436	0.70	∅
7×4	NR	4.2	17.0	531	0.85	304726
8×4	NR	4.2	18.3	610	0.99	304335
10×4	NR	4.2	20.7	736	1.17	∅
12×4	NR	4.2	20.7	791	1.12	304228
14×4	NR	4.2	22.1	910	1.31	304727
1×6	L	4.7	6.9	109	0.14	∅
2×6	NR	4.7	12.1	250	0.41	217828
3×6	NR	4.7	12.8	316	0.40	215519
4×6	NR	4.7	14.3	404	0.53	213135
4G6	2LNPE	4.7	14.3	404	0.53	214972
5×6	NR	4.7	16.0	518	0.67	∅
6×6	NR	4.7	17.4	595	0.82	∅
7×6	NR	4.7	19.3	716	1.06	∅

Con- struction	Core function	Core Ø	Outer Ø	Weight	Fire load	Order no.
n × mm ²			mm	kg / km	kWh / m	
1 × 10	L	6.1	8.4	165	0.21	Ø
2 × 10	NR	6.1	15.1	383	0.64	305813
3 × 10	NR	6.1	16.4	517	0.76	221677
4 × 10	NR	6.1	18.1	653	0.92	222976
5 × 10	NR	6.1	20.2	821	1.20	301723
6 × 10	NR	6.1	22.3	953	1.36	Ø
7 × 10	NR	6.1	24.3	1109	1.59	Ø
1 × 16	L	7.2	9.5	229	0.26	Ø
2 × 16	NR	7.2	18.2	574	0.88	224005
3 × 16	NR	7.2	19.7	757	1.04	221678
4 × 16	NR	7.2	21.8	960	1.30	226254
5 G 16	NRPE	7.2	24.4	1195	1.65	304166
1 × 25	L	8.6	11.2	331	0.35	Ø
2 × 25	NR	8.6	21.2	824	1.21	Ø
3 × 25	NR	8.6	22.4	1064	1.33	Ø
4 × 25	NR	8.6	25.0	1369	1.68	Ø
5 G 25	NRPE	8.6	27.8	1713	2.16	Ø
1 × 35	L	10.1	12.8	448	0.45	Ø
2 × 35	NR	10.1	24.3	1101	1.55	Ø
3 × 35	NR	10.1	26.1	1459	1.76	Ø
4 × 35	NR	10.1	29.2	1937	2.22	Ø
5 G 35	NRPE	10.1	32.4	2377	2.77	Ø



BETAflam® 145 C-flex UL/cUL AWM 4486, 125 °C 1000 V

Shielded connection and power cable – temperature resistant



Competitive advantage

- Very high resistance to temperature, service temperature up to +145 °C
- Resistance to cold up to –55 °C
- Best fire performance, halogen free
- EMC-optimised braided shield
- Good media resistance
- Electron-beam cross-linked
- Nominal voltage 1000 V

BETAflam® 145 C-flex UL/cUL

Application

Fixed and flexible application in dry, humid and wet rooms. Good weather, ozone and UV resistance. Extensively oil resistant. Intended for installation outdoors. Typical areas of application are connections of:

- Conveyor and assembly lines
- Conveying / production lines
- Power plants / switchgears

Construction

- | | |
|-----------------------|--|
| ■ Conductor | Tinned fine copper strands acc. to VDE 0295/IEC 60228, class 5 |
| ■ Insulation | Polyolefine copolymer electron-beam cross-linked |
| ■ Core identification | ● black with white numbers |
| ■ Shield | Tinned fine copper braid |
| ■ Colour of sheath | ● black |

Electrical properties

Nominal voltage	U ₀ /U	1000 V
Testing voltage	Conductor / Conductor	3500 V
	Conductor / Shielding	2500 V

Thermal properties

Conductor temperature	fixed installation	+145 °C max.
	occasionally moved	+120 °C max.
Short-circuit temperature		+280 °C max.
Ambient temperature	fixed installation	–55 °C min.
	occasionally moved	–35 °C min.

Bending radius

For fixed installation	> 4 × outer Ø
Occasionally moved	> 12 × outer Ø

Standards / material properties

- Halogen free: IEC 60754-1, EN 50267-2-1
- No corrosive gases: IEC 60754-2, EN 50267-2-2
- No toxic gases: NF X 70-100
- Low smoke density: IEC 61034
- Flame retardant: EN/IEC 60332-1-2, FT 1, FT 2
- Non-flame propagating: IEC 60332-3, NF C 32-070
- Low fire load: DIN 51900

Approvals

- UL AWM Style 4486, 125 °C 1000 V, file no. E146164
- cUL AWM I/II A/B, 125 °C 1000 V (cUL is equivalent to approbation according to CSA)
- Germanischer Lloyd (GL) certificate no. 96627-94HH
- Lloyd's Register (LR) certificate no. 03/20057
- BUREAU VERITAS (BV) certificate no. 13348/B1 BV
- DET Norske Veritas (DNV) *
- CHINA CLASSIFICATION SOCIETY (CCS) certificate no. HB11W00001_02

Special features

Special types upon request

* only valid for cross-section range 0.5 - 4 mm²

Con- struction	Core function	Core Ø	Outer Ø	Weight	Fire load	Order no.
n × mm ²		mm	mm	kg / km	kWh / m	
2 × 0.5	NR	1.9	6.2	49	0.12	∅
3 × 0.5	NR	1.9	6.7	64	0.12	∅
4 × 0.5	NR	1.9	7.2	77	0.15	∅
5 × 0.5	NR	1.9	7.8	91	0.18	∅
6 × 0.5	NR	1.9	8.3	107	0.21	∅
7 × 0.5	NR	1.9	8.8	123	0.24	∅
8 × 0.5	NR	1.9	9.4	138	0.27	∅
10 × 0.5	NR	1.9	10.2	160	0.32	∅
12 × 0.5	NR	1.9	10.2	167	0.31	∅
1 × 0.75	L	2.2	4.7	33	0.07	∅
2 × 0.75	LN	2.2	7.1	71	0.16	∅
2 × 0.75	NR	2.2	7.1	71	0.16	308592
3 × 0.75	NR	2.2	7.4	83	0.16	308593
3 G 0.75	NRPE	2.2	7.4	83	0.16	∅
4 × 0.75	NR	2.2	8.0	98	0.18	308594
4 G 0.75	NRPE	2.2	8.0	98	0.18	∅
5 × 0.75	NR	2.2	8.7	118	0.23	308595
5 G 0.75	NRPE	2.2	8.7	118	0.23	∅
6 × 0.75	NR	2.2	9.3	137	0.24	∅
7 × 0.75	NR	2.2	10.1	161	0.32	∅
7 G 0.75	NRPE	2.2	10.1	161	0.32	∅
8 × 0.75	NR	2.2	10.8	184	0.37	∅
10 × 0.75	NR	2.2	11.6	210	0.42	∅
12 × 0.75	NR	2.2	11.6	220	0.41	∅
14 × 0.75	NR	2.2	12.2	251	0.46	∅
16 × 0.75	NR	2.2	12.9	279	0.52	∅
19 × 0.75	NR	2.2	14.5	347	0.66	∅
21 × 0.75	NR	2.2	15.3	385	0.74	∅
1 × 1	L	2.4	4.9	38	0.08	∅
2 × 1	NR	2.4	7.5	84	0.17	308596
3 × 1	NR	2.4	7.9	95	0.18	308597
3 G 1	NRPE	2.4	7.9	95	0.18	∅
4 × 1	NR	2.4	8.5	118	0.21	308598
4 G 1	NRPE	2.4	8.5	118	0.21	∅
5 × 1	NR	2.4	9.3	140	0.26	∅
5 G 1	NRPE	2.4	9.3	140	0.26	∅
6 × 1	NR	2.4	9.9	162	0.31	∅
7 × 1	NR	2.4	10.7	190	0.41	∅
7 G 1	NRPE	2.4	10.7	190	0.41	∅
8 × 1	NR	2.4	11.5	219	0.41	∅
10 × 1	NR	2.4	12.5	253	0.48	∅
12 × 1	NR	2.4	12.5	266	0.47	∅
1 × 1.5	L	3.0	5.5	49	0.09	∅
2 × 1.5	NR	3.0	8.6	110	0.23	308608
3 × 1.5	NR	3.0	9.1	124	0.23	308609
3 G 1.5	NRPE	3.0	9.1	124	0.23	308610
4 × 1.5	NR	3.0	9.8	152	0.24	∅
4 G 1.5	NRPE	3.0	9.8	152	0.24	308612
5 × 1.5	NR	3.0	10.7	186	0.32	∅
5 G 1.5	NRPE	3.0	10.7	186	0.32	308613
6 × 1.5	NR	3.0	11.6	220	0.43	∅
7 × 1.5	NR	3.0	12.6	260	0.50	∅
7 G 1.5	NRPE	3.0	12.6	260	0.50	308614
8 × 1.5	NR	3.0	13.7	305	0.60	∅
10 × 1.5	NR	3.0	15.0	309	0.60	∅
12 × 1.5	NR	3.0	15.0	371	0.64	∅
14 × 1.5	NR	3.0	16.0	455	0.75	∅
16 × 1.5	NR	3.0	17.0	502	0.85	∅
19 × 1.5	NR	3.0	19.3	627	1.15	∅
21 × 1.5	NR	3.0	20.3	698	1.28	∅
25 G 1.5	NRPE	3.0	21.7	737	1.33	∅

Con- struction	Core function	Core Ø	Outer Ø	Weight	Fire load	Order no.
n × mm ²		mm	mm	kg / km	kWh / m	
1 × 2.5	L	3.7	6.2	67	0.12	∅
2 × 2.5	NR	3.7	10.0	151	0.33	308615
3 × 2.5	NR	3.7	10.6	174	0.34	308616
3 G 2.5	LNPE	3.7	10.6	174	0.34	∅
3 G 2.5	NRPE	3.7	10.6	174	0.29	308617
4 × 2.5	NR	3.7	11.6	217	0.38	308618
4 G 2.5	NRPE	3.7	11.6	217	0.38	∅
5 × 2.5	NR	3.7	12.6	267	0.46	∅
5 G 2.5	NRPE	3.7	12.6	267	0.46	308620
6 × 2.5	NR	3.7	13.8	321	0.57	∅
7 G 2.5	NRPE	3.7	15.3	385	0.72	308621
8 × 2.5	NR	3.7	16.5	461	0.84	∅
10 × 2.5	NR	3.7	18.3	534	0.93	∅
12 × 2.5	NR	3.7	18.3	569	0.90	∅
14 × 2.5	NR	3.7	19.6	664	1.10	∅
16 × 2.5	NR	3.7	20.7	753	1.23	∅
19 × 2.5	NR	3.7	23.5	934	1.65	∅
21 × 2.5	NR	3.7	24.4	1022	1.80	∅
1 × 4	L	4.2	6.9	92	0.13	∅
2 × 4	NR	4.2	11.0	175	0.34	∅
3 × 4	NR	4.2	11.6	227	0.34	∅
3 G 4	NRPE	4.2	11.6	227	0.34	∅
4 × 4	NR	4.2	12.8	290	0.44	308623
5 G 4	NRPE	4.2	14.2	362	0.57	308624
6 × 4	NR	4.2	15.6	436	0.70	∅
7 × 4	NR	4.2	17.0	531	0.85	∅
8 × 4	NR	4.2	18.3	610	0.99	∅
10 × 4	NR	4.2	20.8	737	1.17	∅
12 × 4	NR	4.2	20.8	794	1.12	∅
14 × 4	NR	4.2	22.1	910	1.31	∅
1 × 6	L	5.0	7.7	121	0.15	∅
2 × 6	NR	5.0	12.9	266	0.43	∅
3 × 6	NR	5.0	13.7	338	0.42	∅
4 × 6	NR	5.0	15.3	432	0.56	∅
5 × 6	NR	5.0	17.0	550	0.70	∅
6 × 6	NR	5.0	18.4	629	0.86	∅
7 × 6	NR	5.0	20.5	759	1.12	∅
1 × 10	L	6.9	9.6	191	0.23	∅
2 × 10	NR	6.9	16.5	425	0.68	∅
3 × 10	NR	6.9	17.9	576	0.68	∅
4 × 10	NR	6.9	20.8	767	0.90	∅
5 × 10	NR	6.9	22.7	943	1.20	∅
6 × 10	NR	6.9	24.9	1085	1.49	∅
7 × 10	NR	6.9	27.2	1264	1.75	∅
1 × 16	L	8.3	11.0	295	0.33	∅
2 × 16	NR	8.3	20.1	653	0.99	∅
3 × 16	NR	8.3	22.0	844	0.97	∅
4 × 16	NR	8.3	24.3	1110	1.32	∅
5 G 16	NRPE	8.3	26.9	1375	1.69	∅
1 × 25	L	9.4	12.1	370	0.42	∅
2 × 25	NR	9.4	22.9	904	1.37	∅
3 × 25	NR	9.4	24.6	1198	1.36	∅
4 × 25	NR	9.4	27.2	1537	1.77	∅
5 G 25	NRPE	9.4	30.4	1957	2.27	∅
1 × 35	L	10.5	13.2	475	0.49	∅
2 × 35	NR	10.5	25.3	1169	1.67	∅
3 × 35	NR	10.5	27.2	1552	1.62	∅
4 × 35	NR	10.5	30.6	2075	2.14	∅
5 G 35	NRPE	10.5	33.6	2523	2.70	∅

BETAtrans® GKW C-flex R 600/1000 V

Shielded control cable – temperature-resistant, with reduced wall thickness



Competitive advantage

- Volume and weight optimised
- Very high resistance to temperature, service temperature up to +120 °C
- Resistance to cold down to –50 °C
- Best fire performance, halogen free
- Resistance to oil and fuel
- Electron-beam cross-linked
- EMC-optimised braided shield

BETAflam® 145 C-flex

Application

For protected installation within and outside of rolling stock and buses. These cables with very small outer diameter are used wherever space is very limited.

Construction

- | | |
|-----------------------|--|
| ■ Conductor | Tinned fine copper strands acc. to VDE 0295/IEC 60228, class 5 |
| ■ Insulation | Polyolefine copolymer electron-beam cross-linked |
| ■ Core identification | ○ white with white numbers |
| ■ Shield | Tinned fine copper braid |
| ■ Outer sheath | Electron-beam cross-linked elastomer |
| ■ Colour of sheath | ● black |

Electrical properties

Nominal voltage

With fixed and protected installation U_0/U 600 / 1000 V

Testing voltage Conductor / Shielding 3500 V

Thermal properties

Conductor temperature fixed installation +120 °C max.

Short-circuit temperature +280 °C max.

Ambient temperature fixed installation –50 °C min.

Bending radius

For fixed installation $> 4 \times \text{outer } \varnothing$

Standards / material properties

- Halogen free: EN 50267-2-1, IEC 60754-1
- No corrosive gases: EN 50267-2-2, IEC 60754-2
- No toxic gases: NF X 70-100,
- Low smoke density: DIN EN 61034-2, IEC 61034
- Flame retardant: EN 50265-2-1, IEC 60332-1
- Non-flame propagating: EN/IEC 60332-3, NF C 32-070
- Low fire load: DIN 51900
- Resistance to oil and fuel: EN 50306-4, EN 60811-2-1

Approvals

- Gost R

Special features

Special types upon request

Con- struction	Core function	Core Ø	Outer Ø	Weight	Fire load	Order no.
n × mm ²		mm	mm	kg / km	kWh / m	
2 × 0.5	NR	1.45	4.8	39	0.08	223380
3 × 0.5	NR	1.45	5.0	44	0.08	223381
4 × 0.5	NR	1.45	5.4	52	0.09	223382
5 × 0.5	NR	1.45	6.0	69	0.11	224444
6 × 0.5	NR	1.45	6.5	80	0.14	223383
7 × 0.5	NR	1.45	7.0	93	0.15	305250
8 × 0.5	NR	1.45	7.4	104	0.17	225727
10 × 0.5	NR	1.45	7.5	110	0.16	224445
12 × 0.5	NR	1.45	7.9	128	0.18	224446
14 × 0.5	NR	1.45	8.3	142	0.21	224447
16 × 0.5	NR	1.45	8.7	157	0.24	224494
18 × 0.5	NR	1.45	9.2	173	0.27	∅
24 × 0.5	NR	1.45	10.2	216	0.30	∅
2 × 0.75	NR	1.7	5.3	47	0.09	223386
3 × 0.75	NR	1.7	5.6	56	0.09	223387
4 × 0.75	NR	1.7	6.2	74	0.11	223388
5 × 0.75	NR	1.7	6.7	90	0.14	∅
6 × 0.75	NR	1.7	7.3	104	0.16	224450
7 × 0.75	NR	1.7	7.7	118	0.18	224451
8 × 0.75	NR	1.7	8.3	136	0.21	224028
10 × 0.75	NR	1.7	8.5	145	0.20	303474
12 × 0.75	NR	1.7	9.0	165	0.22	224452
14 × 0.75	NR	1.7	9.4	186	0.25	∅
16 × 0.75	NR	1.7	9.9	209	0.29	224453
18 × 0.75	NR	1.7	10.5	234	0.32	∅
24 × 0.75	NR	1.7	11.7	292	0.38	∅
2 × 1.0	NR	1.9	5.9	62	0.12	223389
3 × 1.0	NR	1.9	6.2	74	0.11	223390
4 × 1.0	NR	1.9	6.8	92	0.14	223391
5 × 1.0	NR	1.9	7.3	107	0.16	223583
6 × 1.0	NR	1.9	7.9	129	0.19	∅
7 × 1.0	NR	1.9	8.5	146	0.22	∅
8 × 1.0	NR	1.9	9.0	163	0.25	∅

Con- struction	Core function	Core Ø	Outer Ø	Weight	Fire load	Order no.
n × mm ²		mm	mm	kg / km	kWh / m	
10 × 1.0	NR	1.9	9.3	179	0.25	∅
12 × 1.0	NR	1.9	9.8	205	0.26	224455
14 × 1.0	NR	1.9	10.3	232	0.30	∅
16 × 1.0	NR	1.9	10.9	261	0.35	303951
18 × 1.0	NR	1.9	11.5	294	0.39	∅
24 × 1.0	NR	1.9	12.9	367	0.46	∅
2 × 1.5	NR	2.3	6.7	81	0.15	223392
3 × 1.5	NR	2.3	7.1	97	0.13	223393
4 × 1.5	NR	2.3	7.7	119	0.17	223394
5 × 1.5	NR	2.3	8.3	143	0.20	224457
6 × 1.5	NR	2.3	9.1	169	0.24	224458
7 × 1.5	NR	2.3	9.7	194	0.28	306218
8 × 1.5	NR	2.3	10.4	222	0.33	302824
10 × 1.5	NR	2.3	10.9	243	0.30	∅
12 × 1.5	NR	2.3	11.5	283	0.35	224459
14 × 1.5	NR	2.3	12.1	319	0.39	∅
16 × 1.5	NR	2.3	12.7	360	0.45	∅
18 × 1.5	NR	2.3	13.5	403	0.51	∅
24 × 1.5	NR	2.3	15.5	530	0.62	∅
2 × 2.5	NR	2.8	7.7	112	0.16	225732
3 × 2.5	NR	2.8	8.1	136	0.16	225733
4 × 2.5	NR	2.8	8.9	168	0.21	225734
5 × 2.5	NR	2.8	9.7	205	0.25	225735
6 × 2.5	NR	2.8	10.5	242	0.29	∅
7 × 2.5	NR	2.8	11.4	285	0.36	305064
8 × 2.5	NR	2.8	12.3	326	0.43	307140
10 × 2.5	NR	2.8	12.9	358	0.38	∅
12 × 2.5	NR	2.8	13.5	416	0.43	∅
14 × 2.5	NR	2.8	14.3	476	0.49	∅
16 × 2.5	NR	2.8	15.3	560	0.57	∅
18 × 2.5	NR	2.8	16.1	624	0.64	∅
24 × 2.5	NR	2.8	18.5	805	0.77	∅

BETAdrive® Motor connection cable

shielded, non-flame propagation



Competitive advantage

- EMC optimised shield
- Multi-core and flexible
- Symmetrical arrangement of the conductors
- Oil and chemical resistant
- Very high fire performance, halogen free
- UV and weather resistant

BETAdrive® C-flex

Application

This cable has been specially designed and electrically optimised for frequency-converter-controlled electric motors:

- suitable for fixed and flexible installation with average mechanical stress in dry and temporarily humid rooms
- Weather and UV resistant

Construction

- Conductor Bare fine copper strands acc. to VDE 0295 / IEC 60228, class 5
- Insulation Polyolefine copolymer, core identification acc. to HD 308 S2
- Earth conductor Bare fine copper strands
Green-yellow insulation, 3 conductors
- Tape Halogen free plastic tape
- Shield Alu tape, above it tinned fine copper braid
- Dual layer outer sheet Inside → Polyolefine copolymer
Outside → TPE-V
- Colour of sheath ● black

Electrical properties

Nominal voltage	U ₀ /U 600 V / 1000 V	
Testing voltage	Conductor / Conductor	3500 V
	Conductor / Shielding	2500 V

Thermal properties

Continuous operation +90 °C max.
Short-circuit temperature +160 °C max.

Bending radius

	Cable Ø < 30 mm	Cable Ø > 30 mm
during installation	> 12 × outer Ø	> 15 × outer Ø
after installation	> 8 × outer Ø	> 10 × outer Ø

Pull on the conductor

Max. 40 N/mm² ((3 + 3) × conductor cross section × 40 N/mm²)

Standards / material properties

- Halogen free: IEC 60754-1, EN 50267-2-1
- No corrosive gases: IEC 60754-2, EN 50267-2-2
- No toxic gases: NF X 70-100
- Oil resistance: EN 60811-2-1 (24 h / 70 °C), SEV TP 20 B/3 C (72 h / 70 °C)
- Chemical resistance: see table on page 76
- Low smoke density: IEC 61034, EN 61034
- Flame retardant: IEC 60332-1, EN 60332-1
- Non-flame propagating: IEC 60332-3, EN 60332-3
- Low fire load: DIN 51900



Approvals

- Gost R

Construction	Core function	Outer Ø	Weight	Shielding cross-section	Fire load	Cu factor	Order no.
n × mm ²		mm	kg / km	kg / km	kWh / m	kg / km	
3 × 1.5 + 3 × 0,25	3L+3PE	9.7	151	2.8	0.33	90	302799
3 × 2.5 + 3 × 0,5	3L+3PE	11.4	216	4.2	0.44	126	302800
3 × 4 + 3 × 0,75	3L+3PE	13.0	294	4.2	0.54	182	302801
3 × 6 + 3 × 1	3L+3PE	13.8	372	4.2	0.60	250	302802
3 × 10 + 3 × 2,5	3L+3PE	19.1	661	8	1.05	452	302270
3 × 16 + 3 × 2,5	3L+3PE	20.8	862	10	1.23	640	301017
3 × 25 + 3 × 4	3L+3PE	24.4	1253	10	1.63	951	301018
3 × 35 + 3 × 6	3L+3PE	27.6	1650	10	2.01	1301	302271
3 × 50 + 3 × 10	3L+3PE	32.7	2412	19	2.78	1981	301019
3 × 70 + 3 × 16	3L+3PE	36.6	3291	19	3.65	2721	302272
3 × 95 + 3 × 16	3L+3PE	41.4	4013	19	4.18	3459	302273
3 × 120 + 3 × 25	3L+3PE	46.3	5416	19	5.91	4491	301020
3 × 150 + 3 × 25	3L+3PE	51.5	6391	19	6.80	5383	301021
3 × 185 + 3 × 35	3L+3PE	56.7	7653	19	7.61	6705	302274
3 × 240 + 3 × 50	3L+3PE	62.8	9984	19	9.17	8766	302275

Further designs upon request

Current rating

Type	Construction	Installation in conduit in the ground ⁴ 			Installation on trays 		
		Continuous load ¹ / Industrial load ²	Emergency operation ³		Continuous load ¹	Emergency operation ³	
	3 × n + 3 × n mm ²	60 °C / A	90 °C / A	130 °C / A	60 °C / A	90 °C / A	130 °C / A
BETAdrive C-flex	3 × 1.5 + 3 × 0,25	17 / 19	21 / 25	25	16	24	30
BETAdrive C-flex	3 × 2.5 + 3 × 0,5	22 / 26	28 / 33	33	22	32	41
BETAdrive C-flex	3 × 4 + 3 × 0,75	29 / 34	37 / 43	43	30	43	55
BETAdrive C-flex	3 × 6 + 3 × 1	36 / 43	46 / 54	54	37	54	69
BETAdrive C-flex	3 × 10 + 3 × 2,5	52 / 61	65 / 77	77	55	79	101
BETAdrive C-flex	3 × 16 + 3 × 2,5	67 / 79	84 / 99	100	72	103	132
BETAdrive C-flex	3 × 25 + 3 × 4	87 / 103	110 / 129	130	95	137	174
BETAdrive C-flex	3 × 35 + 3 × 6	105 / 124	132 / 156	157	116	166	212
BETAdrive C-flex	3 × 50 + 3 × 10	132 / 156	167 / 196	197	149	214	272
BETAdrive C-flex	3 × 70 + 3 × 16	164 / 193	207 / 244	245	189	270	344
BETAdrive C-flex	3 × 95 + 3 × 16	190 / 224	240 / 282	283	219	314	399
BETAdrive C-flex	3 × 120 + 3 × 25	222 / 261	280 / 329	331	261	373	474
BETAdrive C-flex	3 × 150 + 3 × 25	252 / 296	318 / 374	376	299	428	545
BETAdrive C-flex	3 × 185 + 3 × 35	281 / 331	355 / 418	421	337	482	613
BETAdrive C-flex	3 × 240 + 3 × 50	330 / 388	417 / 491	495	403	576	733

¹ Load over 24 h, 100% nominal current (use primarily for power generating systems)

² Load over 10 h, 100% and 14 h, 60% nominal current (standard use)

³ Maximum over 8 h per day and max. 100 h per year

⁴ Conduit inside diameter at least 1.5 × cable diameter

BETAdrive® Motor connection cable

shielded, with insulation integrity



Competitive advantage

- EMC optimised shield
- Multi-core and flexible
- Symmetrical arrangement of the conductors
- Oil and chemical resistant
- Very high fire performance, halogen free
- UV and weather resistant
- Insulation integrity in case of fire

BETAdrive® FE180 C-flex

Application

This cable has been specially designed and electrically optimised for frequency-converter-controlled electric motors:

- suitable for fixed and flexible installation with average mechanical stress in dry and temporarily humid rooms
- Weather and UV resistant
- Insulation integrity in case of fire

Construction

- | | |
|---------------------------|--|
| ■ Conductor | Bare fine copper strands
acc. to VDE 0295 / IEC 60228, class 5 |
| ■ Insulation | Polyolefine copolymer,
core identification acc. to. HD 308 S2 |
| ■ Earth conductor | Bare fine copper strands,
green-yellow insulation, 3 conductors |
| ■ Tape | Halogen free plastic tape |
| ■ Shield | Alu tape, above it tinned fine copper
braid |
| ■ Dual layer outer sheath | Inside → Polyolefine copolymer
Outside → TPE-V |
| ■ Colour of sheath | ● black |

Electrical properties

Nominal voltage	U ₀ /U 600V/1000V	
	Conductor / Conductor	3500V
Testing voltage	Conductor / Shielding	2500V

Thermal properties

Continuous operation	+ 90 °C max.
Short circuit temperature	+160 °C max.

Bending radius

	Cable Ø < 30 mm	Cable Ø > 30 mm
during installation	> 12 × outer Ø	>15 × outer Ø
after installation	> 8 × outer Ø	>10 × outer Ø

Pull on the conductor

Max. 40 N/mm² ((3 + 3) × conductor cross section × 40 N/mm²)

Standards / material properties

- Halogen free: IEC 60754-1, EN 50267-2-1
- No corrosive gases: IEC 60754-2, EN 50267-2-2
- No toxic gases: NF X 70-100
- Oil resistance: EN 60811-2-1 (24 h / 70 °C),
SEV TP 20 B/3 C (72 h / 70 °C)
- Chemical resistance: see table on page 76
- Low smoke density: IEC 61034, EN 61034
- Flame retardant: IEC 60332-1, EN 60332-1
- Non-flame propagating: IEC 60332-3, EN 60332-3
- Low fire load: DIN 51900
- Insulation integrity FE180: IEC 60331-11 and -21, VDE 0472-814

Construction	Core function	Outer Ø	Weight	Shielding cross-section	Fire load	Cu factor	Order no.
n × mm ²		mm	kg / km	kg / km	kWh / m	kg / km	
3 × 1.5 + 3 × 0.25	3L+3PE	12.7	232	2.8	0.33	102	304973
3 × 2.5 + 3 × 0.5	3L+3PE	13.7	277	4.2	0.44	133	304974
3 × 4 + 3 × 0.75	3L+3PE	14.5	∅	4.2	0.54	182	∅
3 × 6 + 3 × 1	3L+3PE	15.2	427	4.2	0.66	250	∅
3 × 10 + 3 × 2.5	3L+3PE	20.0	∅	8	1.08	452	∅
3 × 16 + 3 × 2.5	3L+3PE	22.7	967	10	1.36	641	∅
3 × 25 + 3 × 4	3L+3PE	26.2	1371	10	1.76	964	306758
3 × 35 + 3 × 6	3L+3PE	29.9	1885	19	2.25	1381	307266
3 × 50 + 3 × 10	3L+3PE	26.3	2714	19	2.86	1941	∅
3 × 70 + 3 × 16	3L+3PE	43.6	3757	19	4.03	2735	∅
3 × 95 + 3 × 16	3L+3PE	44.9	4388	19	5.00	3480	305181
3 × 120 + 3 × 25	3L+3PE	50.4	∅	19	5.42	4492	∅
3 × 150 + 3 × 25	3L+3PE	54.0	6698	19	6.94	5385	304103
3 × 185 + 3 × 35	3L+3PE	60.8	8244	19	8.23	6711	∅
3 × 240 + 3 × 50	3L+3PE	66.0	∅	19	9.53	8779	∅

Further designs upon request

ROFLEX® connecting cable, robust, flexible

CH-N05BQ-F / CH-N1BQ-F

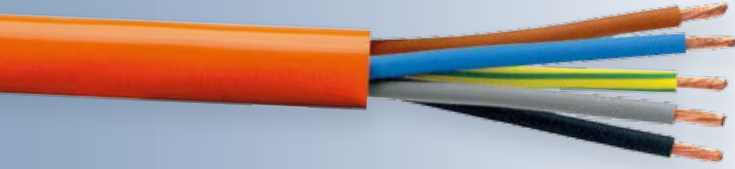

Competitive advantage

- Good abrasion resistance
- Resistance to cold down to -40°C
- Halogen free
- Resistance to oil and fuel
- Good weather, ozone and UV resistance
- Resistant to hydrolysis

ROFLEX®

Application

Suitable for all flexible applications under extreme ambient conditions. Also distinguished by a very high resistance to UV radiation, ozone and mineral oil. Typical applications are:

- Construction sites
- Machinery industry
- Chemical industry
- Food industry
- Agriculture and forestry
- Municipal operations
- Traffic
- Electric hand tools
- Lamps, etc.

Construction

- Conductor Bare fine copper strands acc. to VDE 0295 / IEC 60228, class 5
- Insulation Ethylene propylene rubber (EPR), cross-linked
- Core identification ≤ 5 cores acc. to HD 308 S2 (see page 70)
 ≥ 6 ● cores, black with white numbers and ●
- Outer sheath Polyether polyurethane (PUR)
- Colour of sheath ● Orange (further colours upon request)

Electrical properties

Nominal voltage	$U_0/U \leq 1 \text{ mm}^2$	300 / 500 V
	$U_0/U \geq 1.5 \text{ mm}^2$	600 / 1000 V
Testing voltage		3500 V

Thermal properties

Conductor temperature	fixed installation	$+90^{\circ}\text{C}$ max.
	occasionally moved	$+80^{\circ}\text{C}$ max.
Short-term	fixed installation	$+120^{\circ}\text{C}$ max.
	Ambient temperature	fixed installation -55°C min.
	occasionally moved	-40°C min.

Bending radius

For fixed installation	$> 4 \times \text{outer } \varnothing$
Occasionally moved	$> 8 \times \text{outer } \varnothing$

Standards / material properties

- Halogen free: IEC 60754-1, EN 50267-2-1
- No corrosive gases: IEC 60754-2, EN 50267-2-2
- Oil resistance: EN 60811-2-1 (24 h / 100°C)
- Good abrasion resistance

Special features

- Assembled and shielded cables upon request
- Cable with customer imprint:
Minimum order quantities 300 m $\leq 10 \text{ mm}^2$, 100 m $\geq 16 \text{ mm}^2$
- Upon request acc. to VDE H05BQ-F / H07BQ-F

Con- struction	Core function	Core Ø	Outer Ø	Weight	Fire load	Cu factor	Order no.
n × mm ²		mm	mm	kg/km	kWh/m	kg/km	
2 × 1	LN	2.6	7.0	55	0.25	19.2	188903
3 G 1	LNPE	2.6	7.4	69	0.26	28.8	188918
4 G 1	2LNPE	2.6	8.1	85	0.30	38.0	188917
4 G 1	3LPE	2.6	8.1	85	0.30	38.0	300278
5 G 1	3LNPE	2.6	9.0	105	0.36	48.0	188916
7 G 1	NRPE	2.6	10.9	146	0.46	67.0	211769
2 × 1.5	LN	2.9	7.6	70	0.29	28.8	188761
3 G 1.5	LNPE	2.9	8.2	85	0.32	43.2	188762
4 G 1.5	2LNPE	2.9	9.0	107	0.36	58.0	188763
4 G 1.5	3LPE	2.9	9.0	107	0.36	58.0	300279
5 G 1.5	3LNPE	2.9	10.0	130	0.45	72.0	188764
7 G 1.5	NRPE	2.9	11.9	190	0.60	101.0	188765
8 G 1.5	NRPE	2.9	13.0	212	0.72	115.0	300010
10 G 1.5	NRPE	2.9	14.4	310	0.73	144.0	
12 G 1.5	NRPE	2.9	14.4	280	0.76	173.0	191603
16 G 1.5	NRPE	2.9	16.2	450	0.98	230.0	188914
2 × 2.5	LN	3.5	8.9	98	0.39	48.0	303396
3 G 2.5	LNPE	3.5	9.4	120	0.41	72.0	188766
4 G 2.5	2LNPE	3.5	10.6	158	0.49	96.0	188767
4 G 2.5	3LPE	3.5	10.6	158	0.49	96.0	222884
5 G 2.5	3LNPE	3.5	11.7	200	0.59	120.0	188768
7 G 2.5	NRPE	3.5	14.4	280	0.85	168.0	188769
2 × 4	LN	4.3	12.1	158	0.54	76.8	303398
3 G 4	LNPE	4.3	13.0	208	0.65	115.2	300280
4 G 4	3LPE	4.3	14.4	277	0.77	153.6	300954
5 G 4	3LNPE	4.3	15.8	320	0.93	192.0	188771
7 G 4	NRPE	4.3	18.9	440	1.29	268.8	∅
2 × 6	LN	5.0	13.5	234	0.66	115.2	∅
3 G 6	LNPE	5.0	14.5	300	0.83	172.8	188773
4 G 6	3LPE	5.0	16.1	367	0.97	230.4	222885
5 G 6	3LNPE	5.0	17.8	488	1.18	288.0	188775
7 G 6	NRPE	5.0	21.1	643	1.68	403.2	303368
4 G 10	3LPE	6.2	19.6	570	2.25	384.0	222891
5 G 10	3LNPE	6.2	21.6	694	2.64	480.0	188912
3 G 16	LNPE	7.8	21.9	661	1.182	461.0	218978
4 G 16	3LPE	7.8	23.6	833	3.00	614.4	222892
5 G 16	3LNPE	7.8	26.2	1016	3.54	768.9	188777
3 G 25	LNPE	9.2	24.9	1017	3.50	720.0	305882
4 G 25	3LPE	9.2	27.3	1311	4.46	960.0	222893
5 G 25	3LNPE	9.2	30.1	1525	4.63	1200.0	188778
4 G 35	3LPE	10.5	30.8	1634	4.62	1344.0	305811
5 G 35	3LNPE	10.5	34.1	2050	5.53	1680.0	188779

Con- struction	Core function	Core Ø	Outer Ø	Weight	Fire load	Cu factor	Order no.
n × mm ²		mm	mm	kg/km	kWh/m	kg/km	
1 × 50	L	12.4	16.2	575	1.53	480.0	191705
1 G 50	PE	12.4	16.2	575	1.53	480.0	191707
4 G 50	3LPE	12.4	36.3	2355	6.82	1920.0	222894
5 G 50	3LNPE	12.4	40.5	2990	8.57	2400.0	188780
4 G 70	3LPE	14.2	40.7	3195	8.43	2688.0	305828
5 G 70	3LNPE	14.2	46.0	4021	10.57	3360.0	188781
1 × 95	L	16.4	20.4	984	2.20	912.0	221534
1 G 95	PE	16.4	20.4	984	2.20	912.0	223542
5 G 95	3LNPE	16.4	52.2	5356	12.56	4560.0	188782
1 × 120	L	18.4	22.6	1238	2.55	1152.0	221535
1 G 120	PE	18.4	22.6	1238	2.55	1152.0	223543
1 × 150	L	20.8	25.2	1531	3.15	1440.0	221536
1 G 150	PE	20.8	25.2	1531	3.15	1440.0	223544
1 × 185	L	22.9	27.5	1845	3.51	1776.0	221537
1 G 185	PE	22.9	27.5	1845	3.51	1776.0	223545
1 × 240	L	25.8	30.6	2389	4.01	2304.0	221538
1 G 240	PE	25.8	30.6	2389	4.01	2304.0	223546

Further designs upon request

G = with gr/ye buffered fiber ●●



BETAflam® TRAFO-FLEX 600 / 1000 V

Single-core cable – flexible

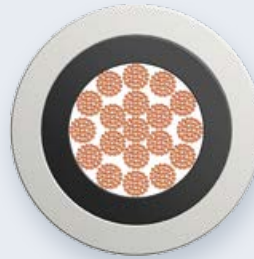
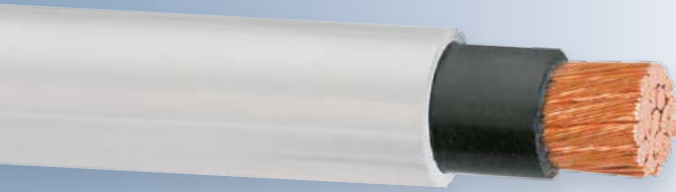

Competitive advantage

- Flame-retardant, halogen free
- Compact strand structure suitable for standard or DIN cable shoes
- Cross-linked EPR isolation

BETAflam® TRAFO-FLEX

Application

Fixed or flexible installation with average mechanical stress in dry, humid and wet rooms. Special strand structure enables problem-free connection with standard or DIN cable shoes. Safe electrical connection thanks to ethylene propylene caoutchouc insulation.

Construction

- Conductor Bare fine copper strands acc. to VDE 0295 / IEC 60228, class 5
- Insulation Ethylene propylene rubber (EPR), cross-linked
- Outer sheath Polyolefine copolymer
- Core identification ● Grey (further colours upon request)

Electrical properties

Nominal voltage	U_0/U with fixed installation 600 / 1000V
Testing voltage	3500V

Thermal properties

Conductor temperature	fixed installation	+90 °C max.
	occasionally moved	+80 °C max.
Short-term	fixed installation	+120 °C max.
	Ambient temperature	fixed installation
	occasionally moved	-25 °C min.

Bending radius

For fixed installation	> 6 × outer Ø
Occasionally moved	> 8 × outer Ø

Standards / material properties

- Halogen free: IEC 60754-1, EN 50267-2-1
- No corrosive gases: IEC 60754-2, EN 50267-2-2
- No toxic gases: NF X 70-100
- Flame retardant: EN/IEC 60332-1-2

Approvals

- Gost R





Special features

- For connection and fixing systems please request our matching accessories
- Shielded single core cable upon request
- Multi-core cable upon request

Construction	Core function	Strand structure	Strand \varnothing	Outer \varnothing	Weight	Bending radius	Pulling force	Order no.
$n \times \text{mm}^2$		$n \times \text{mm}^2 \varnothing$	mm	mm	kg/km	mm	kN	
1 × 95	L	437 × 0.5	13.0	20.4	1038	122	5.7	221227
1 G 95	PE/PEN	437 × 0.5	13.0	20.4	1038	122	5.7	221891
1 × 120	L	570 × 0.5	14.8	22.6	1302	136	7.2	221532
1 G 120	PE/PEN	570 × 0.5	14.8	22.6	1302	136	7.2	221894
1 × 150	L	702 × 0.5	17.0	25.2	1606	151	9.0	221029
1 G 150	PE/PEN	702 × 0.5	17.0	25.2	1606	151	9.0	221896
1 × 185	L	864 × 0.5	18.6	27.5	1930	165	11.0	221239
1 G 185	PE/PEN	864 × 0.5	18.6	27.5	1930	165	11.0	221897
1 × 240	L	1147 × 0.5	21.4	30.6	2489	184	14.4	221030
1 G 240	PE/PEN	1147 × 0.5	21.4	30.6	2489	184	14.4	221210
1 × 300	L	1431 × 0.5	23.7	33.8	3075	203	18.0	221533
1 G 300	PE/PEN	1431 × 0.5	23.7	33.8	3075	203	18.0	∅
1 × 400	L	1887 × 0.5	27.2	38.4	4053	235	24.0	221976

Further designs upon request

Current rating, alternating current values

Construction	Installation in conduit in the ground		Installation in air		R 20 °C [Ω]/km
					
$n \times \text{mm}^2$	A / 60°C	A / 90°C	A / 60°C	A / 90°C	
1 × 95	235	296	277	400	0.206
1 × 120	272	343	326	472	0.161
1 × 150	312	393	383	553	0.129
1 × 185	349	441	435	628	0.106
1 × 240	409	516	520	751	0.080
1 × 300	462	584	599	865	0.064
1 × 400	539	682	722	1042	0.048

max. current rating in industrial load (10 h 100 %, 14 h 60 %)

Reduction factor with parallel conductors

Conductors per phase	Factor
1	1.00
2	0.93
3	0.90
4	0.88
5	0.86
6	0.85
8	0.82
10	0.78

Technical information

Fire behaviour
Electron-beam cross-linking
fire performance
Construction
Electron-beam cross-linking
Halogen-free
Chemical resistance
Current rating
Atherm[®]
Core identification

Technical information	68
Dimensions and weights	70
Core identification acc. to HD 308 S2	70
Current rating 120 °C	71
Current rating 90 °C	72
Ambient conditions	74
Electron-beam cross-linking	75
Chemical resistance	76
Halogen-free	77
Corrosive effects of combustion gases	77
Smoke density	78
Flame retardant	78
No flame propagation	79
Insulation integrity under fire	79
Insulation integrity with mechanical shock	80
System integrity	80
Duration of system insulation integrity in the building	81
Further products	82

Dimensions / Weights

Fine Cu-strands for single core and multi core cables

Dimensions, weights for conductor construction acc. to DIN VDE 0295, IEC 60228 class 5

Construction	Single wire max.	Cu-factor max.	Conductor Ø		Max. resistance at 20 °C	
			Bare Cu	Tinned Cu		
mm ²	Ø mm	kg / km	~ mm	[Ω] / km	~ mm	[Ω] / km
0.25	0.16	2.4	0.7	75.0	0.7	77.5
0.33	0.16	3.2	0.8	55.5	0.8	57.2
0.50	0.20	4.8	1.0	39.0	0.9	40.1
0.75	0.20	7.2	1.2	26.0	1.2	26.7
1	0.20	9.6	1.3	19.5	1.3	20.0
1.5	0.25	14.4	1.6	13.3	1.6	13.7
2.5	0.25	24.0	2.1	7.98	2.1	8.21
4	0.30	38.4	2.6	4.95	2.6	5.09
6	0.30	57.6	3.2	3.30	3.2	3.39
10	0.40	96.0	4.1	1.91	4.1	1.95
16	0.40	154.0	5.4	1.21	5.5	1.24
25	0.40	240.0	7.3	0.780	6.6	0.795
35	0.40	336.0	7.6	0.554	7.7	0.565
50	0.40	480.0	9.2	0.386	9.9	0.393
70	0.50	672.0	11.0	0.272	11.9	0.277
95	0.50	912.0	13.0	0.206	13.2	0.210
120	0.50	1152.0	14.8	0.161	15.0	0.164
150	0.50	1440.0	17.0	0.129	17.3	0.132
185	0.50	1776.0	18.6	0.106	18.9	0.108
240	0.50	2304.0	21.4	0.0801	21.4	0.0817
300	0.50	2880.0	23.7	0.0641	23.5	0.0654
400	0.50	3840.0	27.5	0.0486	27.5	0.0495

Core identification

acc. to HD 308 S2

Cable with green-yellow core

Number of cores	Core function	Core colour
1	PE	green-yellow
3	LNPE	brown, light blue, green-yellow
4*	2LNPE	brown, light blue, black, green-yellow
4	3LPE	brown, black, grey, green-yellow
5	3LNPE	brown, black, grey, light blue, green-yellow
> 5	NRPE	black with printed numbers, green-yellow

* no standard, but permissible for certain applications

Cables without green-yellow core,





Cables with concentric external conductor

Number of cores	Core function	Core colour
1	L	black
2	LN	brown, light blue
3	3L	brown, black, grey
4	3LN	brown, black, grey, light blue
> 5	NR	black with printed numbers

Current rating 120 °C

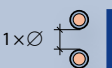
Ambient temperature 30 °C

BETAtherm® 145

Construction mm ²	Free in air	On surfaces without opposite contact	On surfaces with opposite contact	In conduit, duct, housing
	 1 × Ø	 1 × Ø		
	A	A	A	A
0.25	13	12	9	7
0.33	17	16	11	9
0.50	19	18	13	10
0.75	24	23	16	13
1	31	29	21	16
1.5	39	37	26	21
2.5	51	48	34	27
4	68	65	45	36
6	88	84	59	47
10	121	115	80	64
16	160	152	106	85
25	211	200	140	112
35	261	248	174	139
50	320	304	213	170
70	411	390	273	219
95	502	477	334	267
120	587	558	390	312
150	680	646	452	362
185	781	742	519	415
240	931	884	619	495
300	1091	1036	726	580
400	1305	1240	868	694
500	1539	1462	1023	819
630	1790	1701	1190	952

Conversion factors for grouping





Number*	Current rating at 120 °C			
		Factor	Factor	Factor
1	–	× 1.00	× 1.00	× 1.00
2	–	× 0.94	× 0.85	× 0.80
3	–	× 0.90	× 0.79	× 0.70
4	–	× 0.90	× 0.75	× 0.65
5	–	× 0.90	× 0.73	× 0.60
6	–	× 0.90	× 0.72	× 0.57
7	–	× 0.90	× 0.72	× 0.54
8	–	× 0.90	× 0.71	× 0.52
9	–	× 0.90	× 0.70	× 0.50
10	–	× 0.90	–	× 0.48
12	–	× 0.90	–	× 0.45

* Number of alternating or three phase currents consisting of single-core cables.
 Continuous operation with the current ratings according to table above.
 This gives a conductor temperature of 120 °C. (Calculation acc. IEC 60287)

Current rating 90 °C

Ambient temperature 30 °C

BETAtherm® 90 | BETAtherm® 110 | BETAtherm® 145





Construction	Free in air	On surfaces without opposite contact	On surfaces with opposite contact	In conduit, duct, housing
				
mm ²	A	A	A	A
0.25	12	11	8	6
0.33	15	14	10	8
0.50	17	16	11	9
0.75	22	21	15	12
1	28	27	19	15
1.5	35	33	23	19
2.5	46	44	31	24
4	62	59	41	33
6	80	76	53	43
10	110	105	73	59
16	145	138	96	77
25	192	182	128	102
35	237	225	158	126
50	291	276	194	155
70	374	355	249	199
95	456	433	303	243
120	534	507	355	284
150	618	587	411	329
185	710	675	472	378
240	846	804	563	450
300	995	945	662	529
400	1214	1153	807	646
500	1414	1343	940	752
630	1657	1574	1102	882

Conversion factors for grouping

Number*	Current rating at 90 °C			
		Factor	Factor	Factor
1	–	× 1.00	× 1.00	× 1.00
2	–	× 0.94	× 0.85	× 0.80
3	–	× 0.90	× 0.79	× 0.70
4	–	× 0.90	× 0.75	× 0.65
5	–	× 0.90	× 0.73	× 0.60
6	–	× 0.90	× 0.72	× 0.57
7	–	× 0.90	× 0.72	× 0.54
8	–	× 0.90	× 0.71	× 0.52
9	–	× 0.90	× 0.70	× 0.50
10	–	× 0.90	–	× 0.48
12	–	× 0.90	–	× 0.45

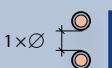
* Number of alternating or three phase currents consisting of single-core cables.
Continuous operation with the current ratings according to table above. This gives a conductor temperature of 90 °C. (Calculation acc. IEC 60287)

BETAtherm® 120 1.8 / 3 kV

Construction	Free in air	On surfaces without opposite contact	On surfaces with opposite contact	In conduit, duct, housing
				
mm ²	A	A	A	A
0.25	–	–	–	–
0.33	–	–	–	–
0.50	17	16	11	9
0.75	23	22	15	12
1	27	26	18	14
1.5	34	32	23	18
2.5	45	43	30	24
4	60	57	40	32
6	76	72	51	40
10	107	102	71	57
16	146	139	97	78
25	195	185	130	104
35	240	228	160	128
50	306	291	203	163
70	384	365	255	204
95	464	441	309	247
120	546	519	363	290
150	630	599	419	335
185	719	683	478	383
240	845	803	562	450
300	991	941	659	527
400	1207	1147	803	642
500	1412	1341	939	751
630	1655	1572	1101	880

Conversion factors for grouping

Number*	Current rating at 90°C			
		Factor	Factor	Factor
1	–	× 1.00	× 1.00	× 1.00
2	–	× 0.94	× 0.85	× 0.80
3	–	× 0.90	× 0.79	× 0.70
4	–	× 0.90	× 0.75	× 0.65
5	–	× 0.90	× 0.73	× 0.60
6	–	× 0.90	× 0.72	× 0.57
7	–	× 0.90	× 0.72	× 0.54
8	–	× 0.90	× 0.71	× 0.52
9	–	× 0.90	× 0.70	× 0.50
10	–	× 0.90	–	× 0.48
12	–	× 0.90	–	× 0.45

* Number of alternating or three phase currents consisting of single-core cables.
 Continuous operation with the current ratings according to table above.
 This gives a conductor temperature of 90°C. (Calculation acc. IEC 60287)

Ambient conditions

Current rating 90 °C and 120 °C

Ambient temperature 30 °C

Rooms which are sufficiently large or well ventilated, in which the ambient temperature does not increase noticeably as a result of heat loss from the wires.

Protection against direct heat from sun rays etc.

Conversion factors for deviating ambient temperatures (basis 30 °C)

Temperature	Current rating at 90 °C	Current rating at 120 °C
°C	Factor	
20	× 1.08	× 1.05
30	× 1.00	× 1.00
40	× 0.91	× 0.94
50	× 0.81	× 0.88
60	× 0.71	× 0.82
70	× 0.57	× 0.75
80	× 0.41	× 0.67
90		× 0.58
95		× 0.53
100		× 0.47
105		× 0.41
110		× 0.33
115		× 0.24

Electron-beam cross-linking

Physical irradiation cross-linking

We cross-link our cable insulations with high energy electrons (betarays) in our own state-of-the-art irradiation centre. These electrons cede their kinetic energy when slowed down in the polymer. Through the impact of the electrons radicals are built, which with chemical reaction interlink the molecules.

Cross-linked insulation materials

Cross-linking binds together the polymer chains by means of a chemical linking (in the amorphous phase). This leads to a three-dimensional network. The polymer chain can no longer move freely (irrespective the temperature). Above the melting temperature the material can no longer flow but it goes into a rubber-like elastic state.

Advantages of cross-linked insulation materials

- Increased shear and compressive strength
- Improved integrity in case of electrical failures (overload, short circuit)
- Improved resistance to chemicals
- Infusible, soldering iron resistance
- Improved impact strength and crack resistance
- Better weather and abrasion resistance

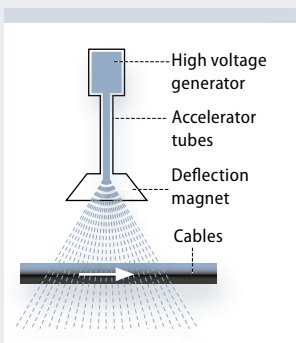

With the electron-beam accelerators the insulation materials can be cross-linked within a few seconds. The homogeneous irradiation and implicit the homogeneous cross-linking are ensured by therefore especially adapted handling systems. Other than in the chemical cross-linking in the irradiation cross-linking no peroxides or hydro-silicones are incorporated into the synthetic mixtures.

BEFORE cross-linking:

Schematic representation of the chain-forming macromolecules before the cross-linking. Free movement of the polymer chains (in the melt and in the solution).



AFTER cross-linking:

Schematic representation of the chain-forming macromolecules after the cross-linking. Three-dimensional cross-linking of polymer chains (very limited freedom of movement).

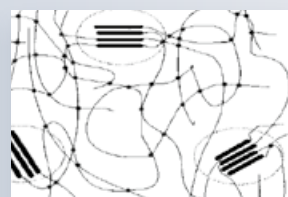

Temperature index as per IEC 60216 / VDE 0304 part 21

The temperature index describes the long-term performance of plastics. The temperature index defines the ageing temperature (in °C), at which the material still has an absolute elongation at break of 50% after 20,000 hours. A 10 °C higher temperature index results in approximately doubling the service life expectation of the plastic.

In order to determine the long term temperature stability of an insulation material the different ageing times corresponding to different temperatures are measured and recorded in a so called Arrhenius-Diagram (ordinate-axis: log time, abscissa axis: the reciprocal absolute temperature). A straight line is drawn to connect the various recorded points.

By prolonging the straight line until it intersects the 20,000 h axis it is possible to determine the service life or the temperature index.

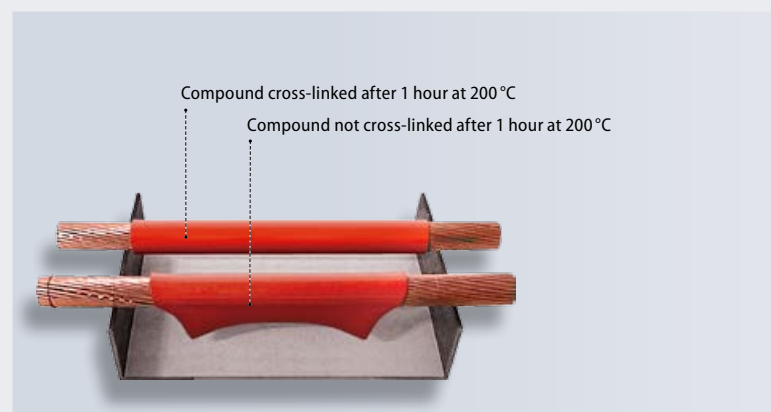
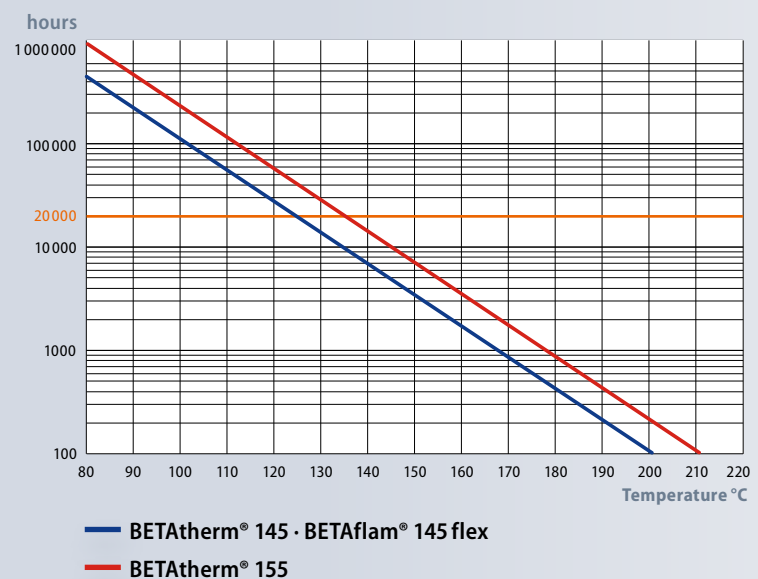

Chemical resistance

CHEMAflex / BETAdrive outer sheath

Tested in our laboratory

- ≤ 3% compatible
- ≤ 15% casual contact
- ≤ 25% casual contact, limited compatible



Medium	Fluids	Time	Temperature	Max. ultimate elongation	Change Tensile strength	
		Days	°C	%	%	
Automotive fluid	Battery acid 37 %	7	23	-2	■	-2
	Hydraulic Brake Fluid	3	50	± 0	■	-2
		7	23	+1	■	-4
	Antifreeze 50 %	3	50	-1	■	-2
		7	23	± 0	■	-1
Automatic Transmissions Fluid	3	50	-4	■	-11	
Industrial fluids	Skydrol LD4	3	50	-5	■	± 0
		7	23	-10	■	-3
Petroleum, oils, fuels	IRM 902	1	70	+23	■	-14
		3	50	-5	■	-11
	IRM 903	1	70	-18	■	-25
Organic solvents	Alcohol 96 %	7	23	+1	■	+1
	Methylethylketone	7	23	+1	■	-4
	Xylol	7	23	+11	■	-11
Acids, alkalis	Sodium hydroxide 10 %	7	23	+1	■	-5
	Sulphuric acid 35 %	7	23	-2	■	-2
Aqueous solutions	Sodium chloride 15 %	7	23	+12	■	-3
	Water	7	23	+5	■	+1

Please be advised that those values are without obligation. For final evaluation, a test under real conditions would be necessary. Further tests could be also made in our laboratory.



Halogen-free

The halogens are the elements of the 7th group in the Periodic Table of Elements:

- Chlorine (Cl) ■ Fluorine (F)
- Bromine (Br) ■ Iodine (I)

Halogen free cables do not have any of these elements. They are called halogens because they form salts when combined with alkalis (hals: Greek for salt); chlorine combined with sodium forms salt (NaCl).

The halogens are an integrated component of many acids

- HCl = Hydrochloric acid, salt acid
- HF = Hydrogen fluoride
- HBr = Hydrogen bromide

The most popular plastic containing halogens is PVC (polyvinylchloride). In case of fire or at high temperature PVC starts to degrade. Hydrochloric acid and other fission products are generated and leads to extremely aggressive corrosion. Therefore the current trend is to replace the halogen containing plastics with halogen-free ones. For instance PVC is currently being replaced at a large scale with polyolefin i.e. polyethylene. Thanks to halogen-free cables the formation of corrosive and toxic gases can be prevented.

Test method

Between 0.5 g and 1.0 g of material is placed into a tube furnace. Over a period of 40 minutes, the temperature inside of the tube furnace is steadily increased to $800\text{ °C} \pm 10\text{ °C}$, the temperature is then maintained for a further 20 minutes. The gases produced are absorbed into a defined catch solution. The test is considered to be passed if the amount of halogen acid evolved does not exceed 0.5 % or 5 mg/g.

Test standards

IEC 60754-1, EN 50267-2-1

Corrosive effects of combustion gases

Corrosive gases act with moisture to produce aggressive acids which corrode metal parts and cause extensive long-term damage, even though the fire damage may only be limited; this is because corrosive gases often spread throughout a building through the ventilation system or within whole installations. The damage may not be limited to the area immediately affected by the fire. Electronic units and electronic contacts are particularly vulnerable, as are free-standing or concrete enclosed steel constructions.

Test method

1000 mg insulation material is burned in a combustion furnace at $\geq 935\text{ °C}$ with pre-defined air supply for over 30 minutes. By means of two gas washing containers, held in the airflow the conductivity and the pH-value are measured. Like that even small quantities of halogen containing substances can be detected and proven.

The test is considered to be passed if

- the pH-value > 4.3
- the conductivity $< 10\ \mu\text{S}/\text{mm}$.

Test standards

IEC 60754-2, EN 50267-2-2

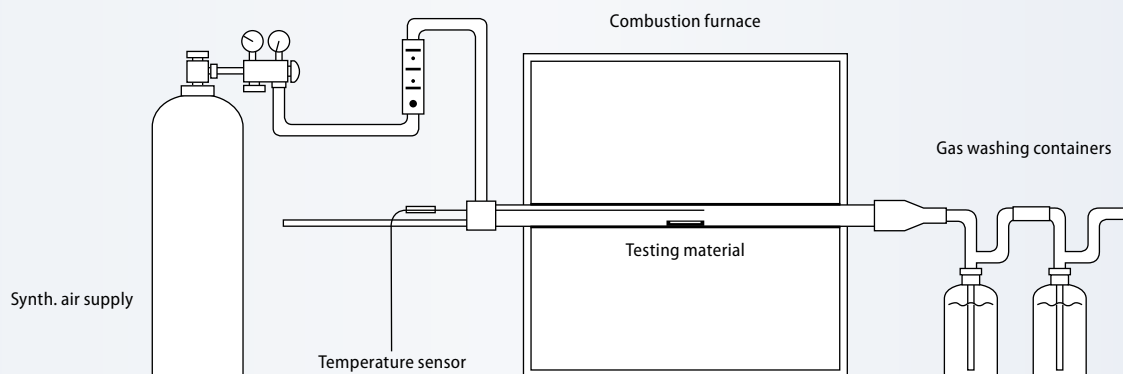

Smoke density

The formation of smoke has several unpleasant consequences. On one hand it considerably lowers the visibility in a fire event, thus impeding the people trapped inside closed rooms escape of and the efforts of the firemen to carry on their rescue and fire fighting actions. Regarding the formation of the combustion gases the PVC comes off quite badly. Regarding the formation of the combustion gases the PVC comes off quite badly. However, this cannot be blamed on the PVC, as frequently assumed. In fact, it is caused by the additives included in the PVC – particularly the softening agents, which normally lead to considerable smoke production.

Test method

The density of smoke emission can be determined by measuring of the light penetrability. Cable samples are lit with alcohol in a test chamber (cubical with an edge length of 3 m). The so formed smoke is uniformly spread by a ventilator and influences the light measuring section.

The test is considered to be passed when the following light penetrability is reached:

Dangerous level	Requirements
■ HL 1	–
■ HL 2 and HL 3	60 %
■ HL 4	70 %

Test standards

IEC 61034, EN 61034

IEC 61034, EN 61034

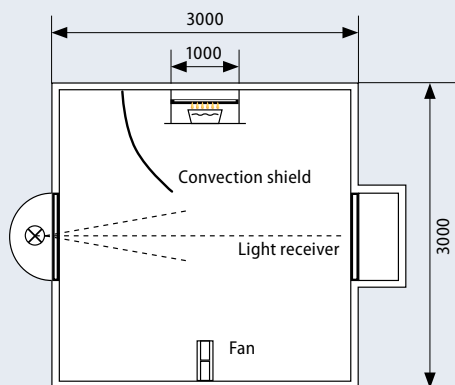

Flame retardant

Flame retardant cables are cables which, when installed as a single cable, although ignitable on exposure to flame source, will greatly reduce flame spread and self extinguish once the flame source is removed.

However in a vertical cable bundle, e.g. in vertical risers, fire can spread along the cables (chimney effect). In order to avoid this danger, the so called «no flame propagating» cables should be used.

Test method

This test procedure describes the minimum requirement on flame-retardant conductors. This only applies for individual cores or individual cables.

A lead wire or a cable is flame treated with a propane-air-burner (1 kW flame).

Test duration

- $\varnothing \leq 25$ = 60 s
- $\varnothing 25 \dots 50$ = 120 s
- $\varnothing 50 \dots 75$ = 240 s
- $\varnothing > 75$ = 480 s

The burning cable should self-extinguish as soon as the fire source has been removed. The fire damage may not be higher than 60 cm.

The test is considered to be passed if the sample has not burned and the damage (carbonisation) has not reached any of the terminations of the sample (> 50 mm)..

Test standards

IEC 60332-1, EN 60332-1

IEC 60332-1-2, EN 60332-1

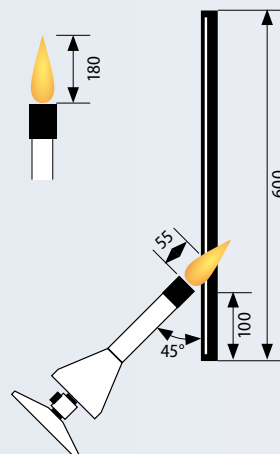

No flame propagation

No flame propagating cables are those cables which can be ignited by a flame source, however they do not allow the fire to spread even if the cable bundle is placed vertically; they are self extinguishing once the fire source is removed.

Test method

This test simulates the chimney effect in vertical cable installations. In a standardized cabinet the cable bundle is kept in a burner fire for 20 - 40 minutes (gas burner 75 ± 5 MJ/h). Thereby the temperature is kept constant to 750°C . Depending on the volume of the non-metal (combustible) materials per running meter it can be differentiated in the categories A F/R, A, B, C and D as follows.

Category	A F/R	A	B	C	D
■ Litres (dm ³) of insulation material per 1 m sample	7	7	3.5	1.5	0.5
■ Flame treatment (min)	40	40	40	20	20

The cables must self-extinguish after removing the fire source. The fire may not have propagated any further than 2.5 m from the burner. With the BETA-flam® safety cables cables this often reaches no further than 50 to 60 cm.

Category	IEC	EN	VDE0482
A F/R	60332-3-21	60332-3-21	part 332-3-21
A	60332-3-22	60332-3-22	part 332-3-22
B	60332-3-23	60332-3-23	part 332-3-23
C	60332-3-24	60332-3-24	part 332-3-24
D	60332-3-25	60332-3-25	part 332-3-21
Apparatus	60332-3-10	60332-3-10	part 332-3-10

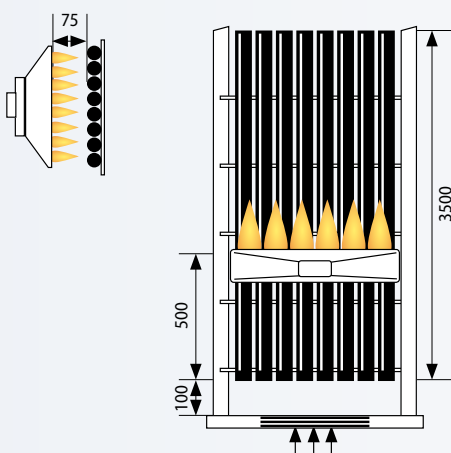

Insulation integrity under fire

The insulation integrity indicates, how long a free cable retains its isolation in a fire without causing a short-circuit. According to its international standard, a cable is laid horizontally over a burner for three hours. The insulation integrity is identified with FE (e.g. FE180 = insulation integrity of 180 minutes): BETAflam® FE180 / E30

Test method

The sample is fastened at specific distances above the burner. The conductor is connected to a power source at nominal voltage via an 2 A fuse.

The test is considered to be passed, if during the test no short circuit or circuit interruption occurs.

Test standards

IEC 60331-11 and -21, DIN VDE 0472-814

IEC 60331-11 and -21, DIN VDE 0472-814

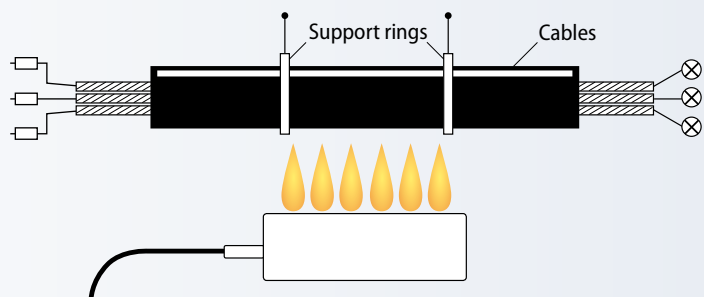

Insulation integrity with mechanical shock

EN 50200, EN 50362, VDE 0482 part 200

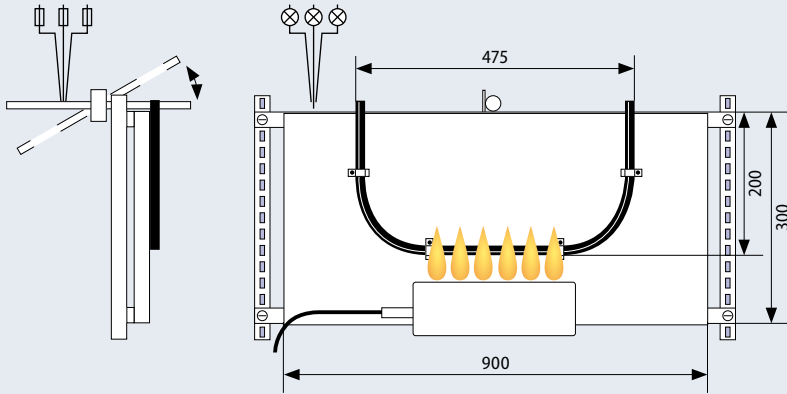

Cables for emergency circuits up to 20 mm diameter are subjected to fire with mechanical shock during a survival time of maximum 90 minutes.

Test method

A single cable is fastened to a test wall under conditions of minimum bending radii and is tested at a minimum test temperature of 830 °C and impacts on the cable support. During the test no rupture of conductors shall appear and voltage must be maintained.

For the purposes of the European Construction Products Directive the survival time serves to classify the cables into PH classes from PH15 to PH90. The test is considered to be passed, if during the test no short circuit occurred.

Test standards

EN 50200, EN 50362, VDE 0482 part 200

Total system integrity under fire

DIN 4102 part 12:1998-11

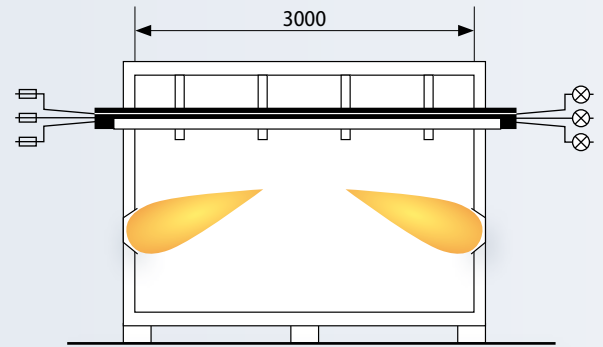

The evidence of the conservation of the functionality of cable installations in event of fire. The test involves the cable as well as the fastening resp. the laying system.

Test method

The profiles are installed together with the fastening system in a testing oven with a minimum length of 3 m. The testing temperature increases according to a specific curve to 850 °C up to 1000 °C. The conductor is connected to a power source at nominal voltage (110 or 400 V) via a 2 A fuse.

The test is considered to be passed, if during the test there is no Short circuit or circuit interruption in the cable system. The classification E30, E60, E90 bases on the least favourable result obtained on at least two identical specimens. The heat-induced increase in conductor resistance is not taken into account during the test.

Test standards

DIN 4102 part 12:1998-11

Duration of system insulation integrity in the building



The duration of the total system integrity of the cable system is based on how long the connected electrical consumer must continue to perform their function in the event of a fire. For this purpose, there are requirements for safety equipment in nearly all national laws, which must be adhered to.

Evacuation

In many countries a period of 30 minutes is sufficient for the alerting and evacuation of people. This functional duration of the systems (e.g. fire alarm systems, safety lighting systems, lifts, natural smoke extraction systems, systems for acoustic signalling and announcement) can be achieved with cable systems of the class E30.

Particularly in buildings like high-rises, hospitals, tunnels and prisons, a functional duration of 60 or 90 minutes may be necessary. Class E60 and E90 cable systems are required for these purposes (e.g. for the supply of bed lifts, etc.).

Fire fighting

After the evacuation of persons, an additional time must be calculated for the work of the fire brigade. Usually a period of 90 minutes from the time of the outbreak of fire applies as sufficient for the fire fighting. The supply of the electrical systems required for this purpose (e.g. water pressure increasing systems, firefighting lifts, mechanical smoke extraction systems) can be achieved with class E90 cable systems.

Planning

Planning an electrical safety system means finding answers to the questions:

- Which parts of the building requires which level of safety?
- Which electrical consumers are to be supplied over which total system integrity duration?
- Which supply cables are affected (safety current circuits)?
- Over which routes must these cables be installed?
- Are there limitations, e.g. with respect to fire load, etc.?

Only then can the selection of the appropriate supporting systems and cable begin.

Further products

BETAtherm[®]

- High-quality, halogen free and flame-retardant industrial cables
- Temperature resistant, high dielectric strength, good properties for processing by machine

BETAflam[®] flex

- High-quality flexible industrial cable
- Excellent media resistance, halogen free and flame-retardant

BETAflam[®] CHEMAflex[®]

- Oil and chemical resistant connecting cables
- Temperature-resistant, halogen free, flame-retardant, easy to process

BETAtrans[®]

- Premium flexible halogen free connection and power cables
- Excellent mechanical and dielectric strength

BETAflam[®] Solar

- Double insulated lead wires
- Electron-beam cross-linked, halogen free
- For solar power applications

BETAjet[®]

- 400 Hz ground power cable systems for external power supply of aircraft on the ground
- For mobile and static applications

BETAlux[®]

- Media resistance 5 kV-primary cables and secondary cables
- Feeder cables for airfield lighting

BETAflam[®]

- Conductors and cables for the highest safety requirements
- Flame-retardant, reduced smoke gas emission, non-fire-propagating

BETAfixss[®]

- Cable supporting system with total system integrity during a fire

BETApower

- Medium voltage power cable TRI-DELTA[®] and Fireprotec
- Low voltage cables GKN and GN-CLN
- Flexible single core cable BETAflam[®] TRAF0-FLEX
- Accessories for cables

BETAsolution[®]

- The solution for cable system engineering
- Everything from one place for energy and communications transmission

MegaLine[®]

- High-quality solutions for passive cabling infrastructure in copper data, patch and trunk cable
- Innovative MegaLine[®] Connect connection technology

GigaLine[®]

- Fiber optic data cable, patch and trunk cable for extremely high bandwidths and long transmission lengths
- Perfectly attuned GigaLine[®] connection technology - powerful components for the construction of a fiber optic cable infrastructure

VarioLine[®]

- Modular system periphery with collecting point and subfloor programmes
- For simple and fast integration in various areas of application

Find out more:

Business Unit Traffic
traffic@leoni.com
www.leoni-traffic.com

LEONI Studer AG

Herrenmattstrasse 20
4658 Däniken
Switzerland
Phone +41 (0) 62 288 82 82
Fax +41 (0) 62 288 83 83

LEONI Kerpen GmbH

Zweifaller Strasse 275–287
52224 Stolberg
Germany
Phone +49 (0)2402 17 1
Fax +49 (0)2402 75154