



**BETAflam® Safety cables
for highest demands**

The Quality Connection

LEONI



**For solutions
that will still
be standard
tomorrow.**

BETAflam® Safety cables

Thanks to their proven quality, BETAflam® safety cables are accepted and used throughout the world.

Produced to international standards, they meet the most demanding quality requirements. The minimal fume emissions and excellent fire resistance characteristics of halogen-free BETAflam® safety cables are compelling for their performance in the event of fire.

Issue: March 2016 © LEONI Studer AG

The contents of this brochure are protected by copyright.
All rights reserved.

We reserve the right to make technical modifications, typographical errors and mistakes.

The current version of the catalogue is downloadable under www.leoni-studer.ch

Safety instructions

Cables are to be used for the designated applications only. In case of failure or damage to the cable or connector, switch off power immediately and replace all damaged parts. Maintenance, repair and replacement of the cables and connectors may only be carried out by authorised and trained personnel.

Waiver

While the information contained in this document has been carefully compiled to the best of our knowledge, it is not intended as a representation or warranty of any kind on our part regarding the suitability of the products concerned for any particular use or purpose and neither shall any statement contained herein be construed as a recommendation to infringe any industrial property rights or as a license to use any such rights. The suitability of each product for any particular purpose must be checked beforehand with our specialists. Our policy is one of continuous material and product development. We reserve the right to offer alternatives consistent with our manufacturing programme at the time of enquiry. All information concerning material properties, fire performance, construction, electrical and technical data, prices etc. reflects our current level of knowledge and is provided without obligation. Dimensions and weights are only given as a guide. The specifications may change any time without prior notice.

General conditions of sale and delivery

We refer to the currently valid General conditions of sale and delivery which can be obtained from the respective companies.



	page
The LEONI Group	4
Future-proof all-in solutions	5
Great brands, great service	6
Green Technology	8
Technologies – investments in sustainable safety	10

Safety cables	12
Safety cables at a glance	14
Safety cables	16
Signal and fire alarm cables	26
Swiss standard cables	34
Connection cables	45
Connection cables for motors	48
Medium voltage single-core cables	53
Signal and fire alarm cables	55
Power cables	57
Installation cables	62

Technical informations	64
Current rating	66
Fire load	68
Core identification acc. to HD 308 S2	70
Halogen-free	71
Degree of acidity of combustion gases	71
Smoke density	72
Flame retardant	72
No flame propagation	73
Circuit integrity under fire	73
Fire performance according to CPR (Construction Product Regulation)	74
Circuit integrity with mechanical shock	76
System integrity	76
Duration of system circuit integrity in the building	77
BETAflam® Approvals	78

BETAfixss® Cable support system at a glance	80
Further products	81

The LEONI Group

Cable expertise for the most various industrial markets



LEONI is a leading supplier of cable systems and related services for the automotive industry and various other industrial sectors.

Our group of companies employs more than 59,000 people in 32 countries. Corporate vision, highest quality and innovative power have made us one of the leading cable manufacturers in Europe. LEONI develops and produces technically sophisticated products ranging from wire and optical fibers to cables through to complete cable systems and also offers the related services. Moreover, the product portfolio comprises strands, standardised cables, hybrid cables, glass fiber as well as special cables, cable harnesses, wiring systems components and fully assembled systems for applications in various industrial markets.

Your markets – our strength.

As diverse as our product and service range are the markets and sectors LEONI is supplying. We focus our activities on customers in the fields of Automotive & Commercial Vehicles, Industry & Healthcare, Communication & Infrastructure, Electrical Appliances and Conductors & Copper Solutions.

We are among the leading European suppliers in the Communication & Infrastructure market to which at LEONI as a cable manufacturer also belong activities in the fields of Infrastructure & Data Communications, Industrial Plant Projects, Solar & Wind-power, Energy & Telecommunications, Irradiation Cross-Linking and Traffic Engineering. Our customers benefit worldwide from innovative as well as reliable and long-lasting products of high quality. LEONI – we create the best connection for your future.

For further information www.leoni.com

Products and services portfolio at a glance

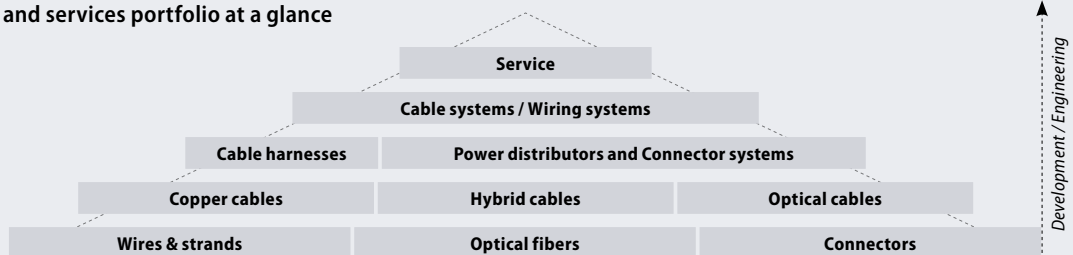

LEONI's core markets



Future-proof complete solutions

For building infrastructure cabling in energy and data technology



Business Unit Energy & Infrastructure

The demands on traffic, data and infrastructure networks will rise in the future. Larger data bandwidths, global networking and increasing individual traffic are associated with constraints on resources, cost pressures and environmental protection. Providing efficient, sustainable and safe power supply as well as energy and data distribution in buildings is the demand of tomorrow. LEONI's business unit Infrastructure & Datacom has realised these insights for quite some time and produces the quality connections of the future today already. Together with the Datacom business unit, LEONI offers future-proof complete solutions for building infrastructure cabling in energy and data technology.

The innovative energy supply of tomorrow

The exponentially increasing energy consumption is rising along with the growing urbanisation and mobility and also determines the trends in the energy industry. We try to face these insights successfully today already. With our products and services for energy production and distribution we want to make an active contribution to the prevention of today's energy loss in the future. Energy and communication will inevitably merge in the future. With the focus on intelligent energy grids we contribute to sparing the environment, resources and costs.

For maximum safety in building cabling

As a leading supplier in the market of structured building cabling, we combine competencies – in energy and communications networks, public buildings, civil engineering, offices, data centres and industry. While increasingly complex applications confront the infrastructure with new challenges, we are obligated to provide maximum safety everywhere. Flexible system and connection solutions also make it possible to be prepared for tomorrow's connections today.

Data networks of the future

In order to do justice to the future exchange of data, we already offer cabling systems that are structured and a safe investment. Bigger volumes of data, global linking and easily scalable data networks will shape the future. Requirements that we are confronting with innovative, safe and sustainable high-grade glass fibre and copper cables and modular cabling and connection systems.

Cost-efficiency in every stage of the project

Our service package BETAsolution® provides on-site consulting from planning, projecting to logistics and installation all the way to project acceptance. Rising costs and time pressures combined with ever-higher requirements for materials and sustainability call for increasingly efficient project management. Major projects like the Gotthard Base Tunnel in Switzerland benefit not only from the comprehensive range but also from our knowledge and skill. BETAsolution® reduces interfaces and considerably increases project efficiency. Specialists ensure comprehensive complete solutions worldwide and thus create a true competitive edge for our clients.

Our long-standing tradition of producing innovative cable products is our pledge to constant peak performance. Starting with our competence centres in Däniken (Switzerland) and Stolberg (Germany), it is necessary to always plan ahead in the fields of development and research for our products.

Connecting tomorrow's world today already then also means looking ahead. Constant advancement and research is our claim in this. We see complexity as a challenge. Being innovative to us means moving forward and simultaneously trusting in our competencies. We create connections that link people safely, quickly and convincingly – today and tomorrow.

For further information www.leoni-energy-Infrastructure.com

Great brands, great service

Put your trust in the best partner to suit your needs

Our commitment to developing innovative products proves our dedication to our responsibility. In conjunction with our consulting services, we create trust and help our partners accomplish maximum safety for people and infrastructure in their projects.

Investors, integrators, designers, installers and the trade – you can now get all your cabling, connectivity and complete cabling solutions from a single source – from copper and fibre optic technology to halogen-free energy cables, with or without circuit integrity. Constant safety, environmental compatibility and energy efficiency innovations complete the list of customer benefits.

Global presence, consulting on site during all stages of a project as well as extensive experience gained in numerous projects and far-reaching synergies inside and outside the LEONI Group makes us international one of the most accredited partners in the field of building and infrastructure cabling.



Infrastructure –

for maximum safety in cabling for buildings

Our products set the standard worldwide – in buildings, in underground construction and in traffic infrastructure. Our cables based on our proprietary patented design and production processes ensure maximum safety and performance. The halogen-free, fire-resistant insulation materials meet all the relevant standards while their extended service life also presents a compelling advantage. Whether as laying systems or highly complex network systems, our full infrastructure range convinces customers worldwide.

- **BETAflam®** according to the VDE standard
Safety and installation cables
- **BETAflam®** according to the British Standard BS 6387
Safety and installation cables
- **BETAfixss®** with circuit integrity under fire acc. to DIN 4102
Certified installation systems



Datacom – for maximum data integrity and bandwidth

From the very beginning of the digital data era, we have fulfilled data networking requirements for both the short term and the far future by using great innovation and a forward-looking approach. The profound expertise of the Infrastructure & Datacom BU in copper and fibre optical cabling technologies represents a powerful advantage in structured cabling systems for industry, data centres and offices – the sustainable copper and glass fibre cables of our own production are among the safest and most innovative products in the primary to tertiary cabling market.

- **MegaLine®**
Copper cables and passive system components
- **GigaLine®**
Fiber optical cables and passive system components
- **VarioLine®**
Modular system peripherals

Energy – the best connection for energy supply

With innovative and sustainable solutions we face the dynamic development in the energy and communication market today already. As one of the leading system and development partners for energy production, transmission and distribution, we accept the responsibility for safe and sustainable energy supply. Our low- and medium-voltage power cables provide convincing durability and resist even the most adverse conditions.

- **BETApower®**
Cable for power generation
- **BETAsolution®**
The total-service-provider for the energy and ICT infrastructure.

Green technology

Our company aim is to combine innovation with sustainability.



Our vision is to create sustainable connections in technological harmony with the natural resources. The cycle of nature gives us the best model to emulate. It is our responsibility to learn from nature and make use of it while conserving it and treating it with care. The growing scarcity of the natural resources and the increasing burden on the environment require a rethink on all levels of society. For LEONI, sustainability is an integral part of group policy. We are the first cable manufacturer in the world to develop a holistic concept for “green technology”.

While trends like globalisation, mobility and urbanisation also determine the markets, sustainability and global responsibility are a central credo. To be considered an innovative cable manufacturer for environmentally friendly technologies – that is our goal. At that, it is of vital interest to us to detect the needs and requirements of tomorrow today and supply the markets of the future with sustainable, future-proof solutions.

Green technology stands for the resource-conserving and low-emission production of sustainable quality cables made with low-pollution elements. We constantly work at optimising the efficiency with which resources are used in the manufacturing process by deploying energy-efficient machines or taking heat recovery measures. More and more locations in our global production network are environmentally certified according to the ISO 14001 standard.

As a worldwide active and leading European supplier of wires, optical fibres, cables and cable systems for communication and infrastructure projects it is our responsibility to constantly optimise the sustainability and durability of our products, system solutions and services and thus lower the environmental load. We have to increase the amount of environmentally compatible raw materials in our cable products as well as the recyclability of processed materials or components and in doing so create end products that are developed for the environmental standard of tomorrow today.

In conjunction with the ecological compatibility, future technologies are measured in terms of efficiency, service life, emission reduction and the conservation of natural resources. Innovative cable products and systems, holistic solutions and maximum performance in project management are the added value which we offer to our customers and business partners. These are also our cornerstones for strong connections into the future.



There are various environmental directives in the European Union (EU). Directive 2012/19/EU WEEE (Waste Electrical and Electronic Equipment) regulates the disposal of electrical and electronic equipment and components. The use of certain hazardous materials in electrical and electronic devices is defined by Directive 2011/65/EU RoHS 2 (Restriction of Hazardous Substances). Chemicals and materials in general are regulated by the law on chemical substances 1907/2006/EC RECh (Registration, Evaluation, Authorisation and Restriction of Chemicals).

This means avoiding the following substances, among others:

- Polybrominated diphenyl ether (PBDE)
- Decabromodiphenyl ether (DecaBDE)
- Perfluorooctane sulfonate (PFOS)
- Pentabromodiphenyl ether (PentaBDE)
- Octabromodiphenyl ether (OctaBDE)
- Lead (Pb)
- Mercury (Hg)
- Cadmium (Cd)
- Hexavalent chromium (Cr VI)
- Polybrominated biphenyls (PBB)



Cables and conductors and their associated connectors are only affected by Directive 2012/19/EU WEEE insofar as they are an internal part of the listed equipment and components.

Cables and conductors have now been included in 2011/65/EU RoHS 2 since 2013 for the first time (Category 11 or as an internal component of the respective product). Fiber optic cables, power cables (>250 V) and installed fixed cables e.g. in premises are not concerned. The only permissible marking according to RoHS 2 is the CE marking, which is printed on the product package.

EU Directive 2012/19/EU on waste electrical and electronic equipment.

EU Directive 2011/65/EU for restriction of the use of certain hazardous substances in electrical and electronic equipment.

EU Regulation 1907/2006/EC (RECh) the chemical regulation of the European Union.



What does RECh mean?

RECh stands for Registration, Evaluation, Authorisation and Restriction of Chemicals.

With RECh, the previous chemical law is basically harmonised, simplified and valid in all EU Member States.

Under RECh, there is a so-called candidate list with substance of very high concern (SVHC), which are subject to obligatory information and should be substituted in the long run. The list of candidate materials is updated twice per year by the European Chemicals Agency (ECHA) in Helsinki.

Technologies – investments in sustainable safety

Universal use with extremely high functional integrity



Our development and production centres LEONI Studer (Switzerland) and LEONI Kerpen (Germany) are linked by one thing in particular: competence. In extensive production areas, we work with state-of-the-art methods and systems in plastics processing, materials processing, extrusion technology, electron beam cross-linking and the testing of all products.

We use state-of-the-art production equipment in order to offer our customers a maximum of safety and quality. New and innovative plastics mixtures and cables are constantly being developed in modern laboratories. The focus is on improved insulating properties, higher temperature tolerances, longer lifetimes, easy handling and better safety features. Our test laboratories for flammability tests, HF technology and optical measurement technology safeguard our quality standards and promote innovation.

This is demonstrated by the large number of approvals and certificates coming from well-known independent testing institutes worldwide.

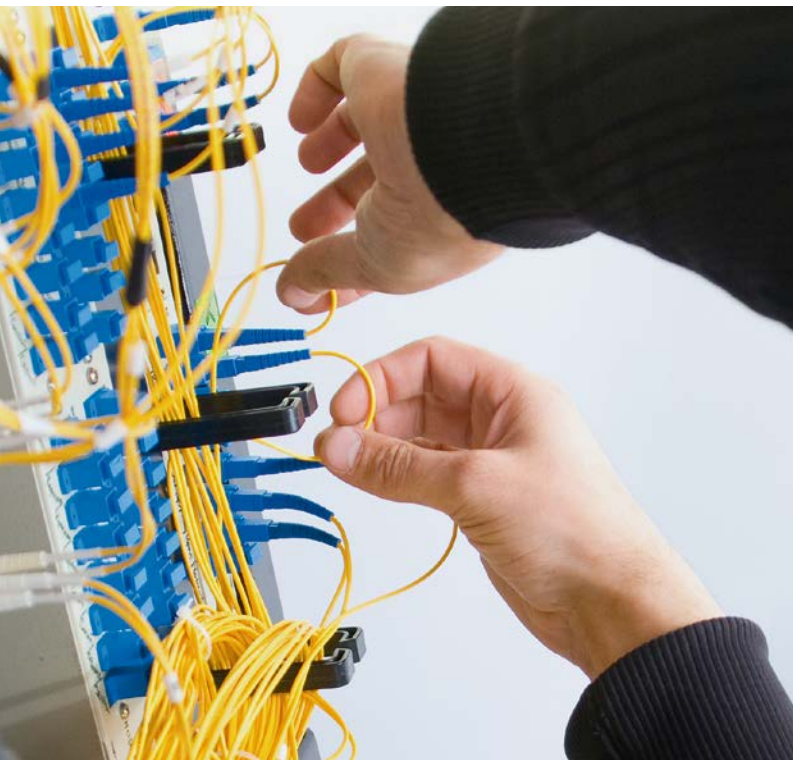

In the fire test laboratory, the fire-resistant properties of our products are tested by certified testers, technicians and engineers. This pool of equipment is used for the very flexible execution of the wide range of measurements required for BS 6387 C.W.Z., IEC 60331-11/21 and DIN 4102 Part 12, as well as customer-specific requirements and special tests. A multitude of national and international certificates provide proof of the company's powers of innovation.

- **Halogen-free**
IEC 60754-1, EN 50267-2-1
- **Degree of acidity of combustion gases**
IEC 60754-2, EN 50267-2-2
- **Smoke density**
IEC 61034, EN 61034
- **Flame retardant**
IEC 60332-1, EN 60332-1, VDE 0482-332-1
- **Circuit integrity**
BS 6387 C.W.Z., DIN VDE 0472-814, EN 50200, EN 50362, IEC 60331-11/21, VdS 3423, VDE 0482-200
- **System integrity under fire**
DIN 4102 part 12
- **IT cabling system Office**
IEC 60332-3, EN 60332-3, VDE 0482-332-3 series
- **IT Verkabelungssysteme für Büro**
EN 50173-2, ISO/IEC 11801
- **IT cabling system Industry**
EN 50173-3, ISO/IEC 24702
- **IT cabling system Data Center**
EN 50173-5, ISO/IEC 24764

Numerous national and international certificates confirm the company's ability to provide innovative solutions.



Safety cables

BETAflam® · ROFLEX® · BETAdrive® · BETApower®

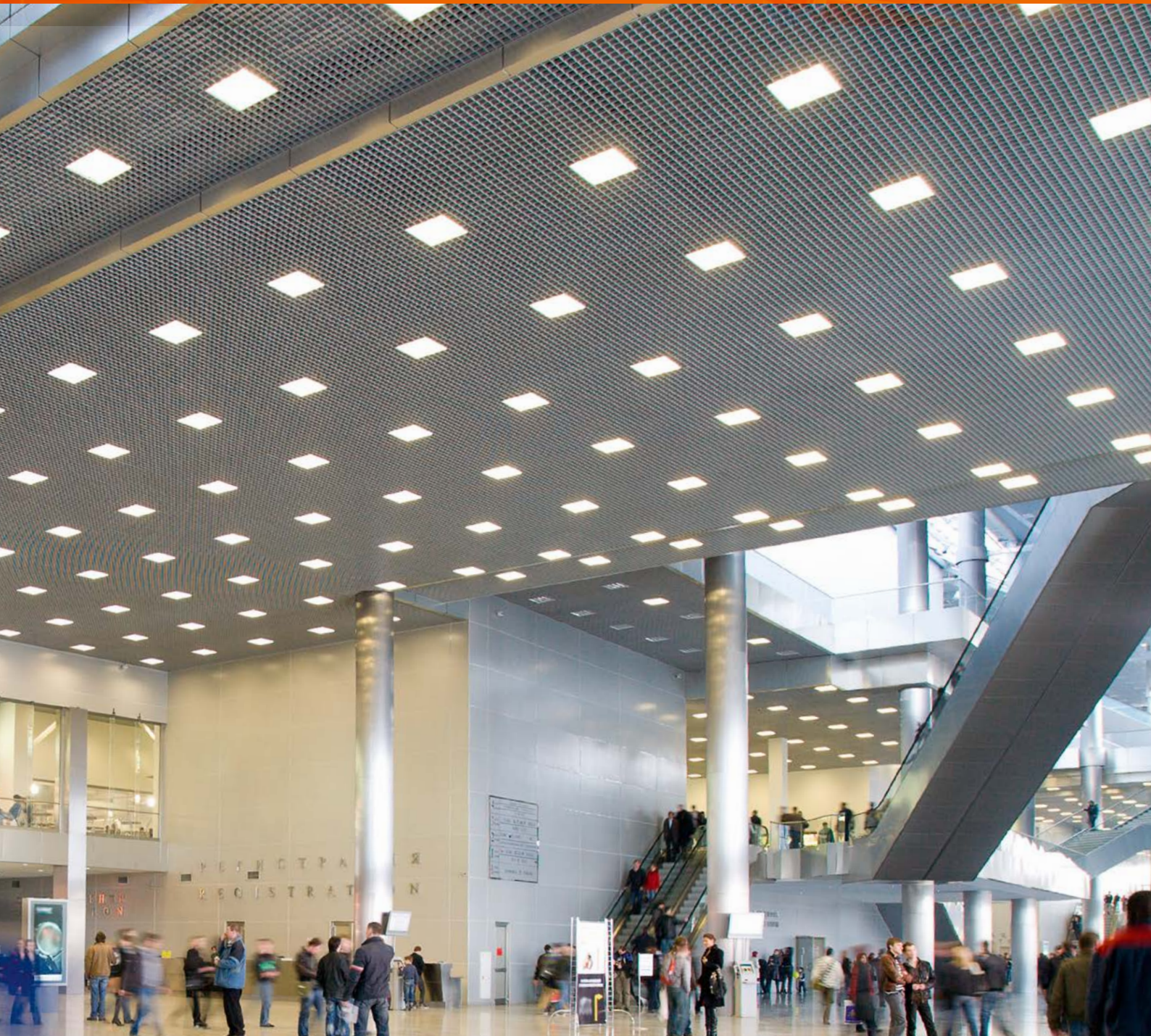

Safety cables		page	
Safety cables at a glance		14	
Safety cables	DIN VDE 0266	BETAflam [®] NHXH FE180 / E30-E60	16
		BETAflam [®] NHXCH FE180 / E30-E60	19
		BETAflam [®] NHXH FE180 / E90	21
		BETAflam [®] NHXCH FE180 / E90	24
Signal and fire alarm cables	DIN VDE 0815	BETAflam [®] JE-H(St)H FE180/E30 SIR	26
	DIN VDE 0815	BETAflam [®] JE-H(St)H FE180 / E30-E90	28
Fire alarm cables	DIN VDE 0815	BETAflam [®] JE-H(St)HRH FE180 / E30-E90	30
Signal and fire alarm cables	DIN VDE 0815	BETAflam [®] JE-HH FE180/E30 SIR	32
Swiss standard cables	CH-N1EZ1-U/-R	BETAflam [®] FE0	34
	CH-N07Z1Z1-F	BETAflam [®] INSTAflex	36
	CH-N1EZ1-U/-R	BETAflam [®] FE5	38
	CH-N1MZ1Z1-U/-R	BETAflam [®] FE180 / E30	40
	armoured CH-N1MZ1Z1Z4Z1-U/-R	BETAflam [®] FE180 / E30-CLE	43
Connection cables	robust, flexible CH-N05BQ-F / CH-N1BQ-F	ROFLEX [®]	45
Connection cables for motors	shielded	BETAdrive [®] C-flex	48
	with circuit integrity	BETAdrive [®] FE180 C-flex	51
Medium voltage cables	with circuit integrity	BETApower [®] Fireprotec 12 / 20 kV	53
Signal and fire alarm cables	DIN VDE 0815	J-H(St)H	55
Power cables	DIN VDE 0276-604	N2XH	57
		N2XCH	60
Installation cables	DIN VDE 0250-214	NHXMH	62

Safety cables at a glance



Safety cables DIN VDE 0266



■ BETAflam® NHXH FE180 / E30-E60
page 16



■ BETAflam® NHXCH FE180 / E30-E60
page 19



Signal and fire alarm cables DIN VDE 0815



■ BETAflam® JE-H(St)H FE180/E30 SIR
page 26



■ BETAflam® JE-H(St)H FE180 / E30-E90
page 28



Swiss standard cables



■ BETAflam® FE0
page 34



■ BETAflam® INSTAflex
page 36



■ ROFLEX®
page 45



■ BETAdrive® C-flex
page 48



Further VDE cable types



■ J-H(St)H
page 55



■ N2XH
page 57





■ BETAflam® NHXH FE180 / E90
page 21



■ BETAflam® NHXCH FE180 / E90
page 24



■ BETAflam® JE-H(St)HRH FE180 / E30-E90
page 30



■ BETAflam® JE-HH FE180/E30 SIR
page 32



■ BETAflam® FE5
page 38



■ BETAflam® FE180 / E30
page 40



■ BETAflam® FE180 / E30-CLE
page 43



■ BETAdrive® FE180 C-flex
page 50



■ BETApower® Fireprotec 12 / 20 kV
page 53



■ N2XCH
page 60



■ NHXMH
page 62



BETAflam® Safety cables

DIN VDE 0266



REACH

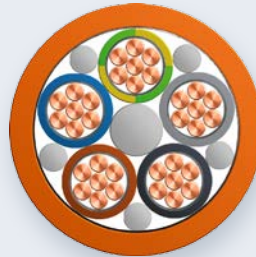

Advantages

- Very high safety standards
- System circuit integrity acc. to DIN 4102 part 12
- DIN approved with LEONI BETAfixss® cable support system
- Halogen-free
- In compliance with REACH directive

BETAflam® NHXH FE180 / E30-E60

Applications

Power cable 0.6 / 1 kV for fixed installation in cable systems with improved fire performance and system circuit integrity acc. to DIN 4102 part 12, e.g. for:

- lighting of escape routes
- fire alarm systems
- smoke exhaust systems
- recommended in areas where people gather and for protection of valuables

Construction

■ Conductors	Bare annealed copper
■ Flame barrier	MICA tape
■ Insulation	BETAflam® cross-linked
■ Inner covering	Tape or filler
■ Sheath	BETAflam® copolymer
■ Core identification	acc. to VDE 0266 resp. HD 308 S2
■ Sheath colour	Orange

Electrical characteristics

Rated voltage	U_0/U 0.6 / 1 kV
Test voltage	4 kV with 50 Hz

Thermal characteristics

Operation temperature	-30 °C up to +90 °C
Laying temperature	-5 °C up to +70 °C
Short circuit temperature (temperature peak < 5 s)	up to +250 °C

Bending radius

cable design	single core	multiple core
during laying	$> 15 \times \text{outer } \varnothing$	$> 12 \times \text{outer } \varnothing$
fixed	$> 8 \times \text{outer } \varnothing$	$> 7 \times \text{outer } \varnothing$

Laying conditions

- Fixed installation indoor, in air or concrete
- Laying in earth or water only in water-proof dry tubes
- Outdoor laying only when protected from direct sunlight and other external impacts

Standards / Material properties

- Halogen-free: IEC 60754-1, EN 50267-2-1, VDE 0482-267-2-1
- No corrosive gases: IEC 60754-2, EN 50267-2-2, VDE 0482-267-2-2
- No toxic gases: NF X 70-100
- Low smoke density: IEC 61034-1 and -2, EN 61034-1 and -2, VDE 0482-1034-1 and -2
- Flame retardant: IEC 60332-1, EN 60332-1, VDE 0482-332-1
- No flame propagation: IEC 60332-3-10 and -3-24, EN 60332-3-10-24, VDE 0482-332-3-24
- Circuit integrity FE180: IEC 60331-11 and -21, VDE 0472-814
- Circuit integrity with shock: EN 50200 PH90 (up to \varnothing 20 mm)
- System circuit integrity: DIN 4102-12, E30 or E60, depending on laying system

Cable type	Constrution	Core function	Outer Ø	Weight	Cu factor
	n × mm ²				
NHXXH-J FE180/E30-E60	1 × 4 RE	PE	7.3	101	38
NHXXH-J FE180/E30-E60	1 × 6 RE	PE	7.8	121	58
NHXXH-J FE180/E30-E60	1 × 10 RE	PE	8.6	166	96
NHXXH-J FE180/E30-E60	1 × 16 RM	PE	10.3	238	154
NHXXH-J FE180/E30-E60	1 × 25 RM	PE	11.9	343	240
NHXXH-J FE180/E30-E60	1 × 35 RM	PE	13.0	457	336
NHXXH-J FE180/E30-E60	1 × 50 RM	PE	14.8	583	480
NHXXH-J FE180/E30-E60	1 × 70 RM	PE	16.6	813	672
NHXXH-J FE180/E30-E60	1 × 95 RM	PE	19.0	1066	912
NHXXH-J FE180/E30-E60	1 × 120 RM	PE	20.8	1319	1152
NHXXH-J FE180/E30-E60	1 × 150 RM	PE	22.9	1607	1440
NHXXH-J FE180/E30-E60	1 × 185 RM	PE	25.3	1986	1776
NHXXH-J FE180/E30-E60	1 × 240 RM	PE	28.3	2623	2304
NHXXH-J FE180/E30-E60	1 × 300 RM	PE	32.2	3471	2880
NHXXH-J FE180/E30-E60	1 × 400 RM	PE	35.9	4300	3840
NHXXH-J FE180/E30-E60	1 × 500 RM	PE	39.7	5400	4800
NHXXH-O FE180/E30-E60	1 × 4 RE	L	7.3	101	38
NHXXH-O FE180/E30-E60	1 × 6 RE	L	7.8	121	58
NHXXH-O FE180/E30-E60	1 × 10 RE	L	8.6	166	96
NHXXH-O FE180/E30-E60	1 × 16 RM	L	10.3	238	154
NHXXH-O FE180/E30-E60	1 × 25 RM	L	11.9	343	240
NHXXH-O FE180/E30-E60	1 × 35 RM	L	13.0	457	336
NHXXH-O FE180/E30-E60	1 × 50 RM	L	14.8	583	480
NHXXH-O FE180/E30-E60	1 × 70 RM	L	16.6	813	672
NHXXH-O FE180/E30-E60	1 × 95 RM	L	19.0	1066	912
NHXXH-O FE180/E30-E60	1 × 120 RM	L	20.8	1319	1152
NHXXH-O FE180/E30-E60	1 × 150 RM	L	22.9	1607	1440
NHXXH-O FE180/E30-E60	1 × 185 RM	L	25.3	1986	1776
NHXXH-O FE180/E30-E60	1 × 240 RM	L	28.3	2623	2304
NHXXH-O FE180/E30-E60	1 × 300 RM	L	32.2	3471	2880
NHXXH-O FE180/E30-E60	1 × 400 RM	L	35.9	4300	3840
NHXXH-O FE180/E30-E60	1 × 500 RM	L	39.7	5400	4800
NHXXH-O FE180/E30-E60	2 × 1.5 RE	LN	11.8	167	29
NHXXH-O FE180/E30-E60	2 × 2.5 RE	LN	12.6	198	48
NHXXH-O FE180/E30-E60	2 × 4 RE	LN	13.1	233	77
NHXXH-O FE180/E30-E60	2 × 6 RE	LN	14.1	285	115
NHXXH-O FE180/E30-E60	2 × 10 RE	LN	15.7	408	192
NHXXH-O FE180/E30-E60	2 × 16 RM	LN	18.9	566	307
NHXXH-O FE180/E30-E60	2 × 25 RM	LN	22.0	839	480
NHXXH-J FE180/E30-E60	3 × 1.5 RE	LNPE	12.4	183	43
NHXXH-J FE180/E30-E60	3 × 1.5 RE	LNPE	12.4	183	43
NHXXH-J FE180/E30-E60	3 × 2.5 RE	LNPE	13.3	221	72
NHXXH-J FE180/E30-E60	3 × 2.5 RE	LNPE	13.3	221	72
NHXXH-J FE180/E30-E60	3 × 4 RE	LNPE	13.7	268	115
NHXXH-J FE180/E30-E60	3 × 6 RE	LNPE	14.9	337	173
NHXXH-J FE180/E30-E60	3 × 10 RE	LNPE	16.6	472	288
NHXXH-J FE180/E30-E60	3 × 16 RM	LNPE	20.1	736	461
NHXXH-J FE180/E30-E60	3 × 25 RM	LNPE	23.4	1069	720
NHXXH-J FE180/E30-E60	3 × 35 RM	LNPE	25.9	1369	1008
NHXXH-J FE180/E30-E60	3 × 50 RM	LNPE	29.8	2198	1440
NHXXH-J FE180/E30-E60	3 × 70 RM	LNPE	33.7	3023	2016
NHXXH-J FE180/E30-E60	3 × 95 RM	LNPE	38.8	3461	2736

-J = with gn/ye conductor ●
 -O = without gn/ye conductor
 RE = round solid, class 1
 RM = round stranded, class 2

L = colour phase conductor br/bk/gr ●●●
 N = colour neutral conductor bl ●
 NR = colour phase conductors bk ● / numbered
 PE = colour earth conductor gn/ye ●

Order no.	
Germany	Switzerland
LKI 8000 0100 0000	
LKI 8000 0200 0000	
LKI 8000 0300 0000	
LKI 8000 0400 0000	
LKI 8000 0500 0000	
LKI 8000 0600 0000	300555
LKI 8000 0700 0000	
LKI 8000 0800 0000	305088
LKI 8000 0900 0000	
LKI 8000 1000 0000	
LKI 8000 1100 0000	306238
LKI 8000 1200 0000	306262
LKI 8000 1300 0000	
LKI 8000 1400 0000	
LKI 8000 1500 0000	
LKI 8000 1600 0000	
LKI 8000 7200 0000	
LKI 8000 7300 0000	305101
LKI 8000 7400 0000	305102
LKI 2119 9700 0000	211997
LKI 8000 7500 0000	
LKI 8000 7600 0000	
LKI 8000 7700 0000	
LKI 8000 7800 0000	
LKI 8000 7900 0000	
LKI 8000 8000 0000	305089
LKI 8000 8100 0000	305090
LKI 3012 2600 0000	301226
LKI 8000 8200 0000	
LKI 8000 8300 0000	
LKI 8000 8400 0000	
LKI 8000 8500 0000	
LKI 1912 2500 0000	191225
LKI 3000 6000 0000	300060
LKI 3028 0300 0000	302803
LKI 8000 8800 0000	
LKI 8000 8900 0000	
LKI 8000 9000 0000	
LKI 8000 9100 0000	
LKI 1912 2700 0000	191227
LKI 8000 2500 0000*	19122705*
LKI 1912 3200 0000	191232
LKI 8000 2600 0000*	19123205*
LKI 2120 6600 0000	212066
LKI 2139 2700 0000	213927
LKI 2139 4500 0000	213945
LKI 2139 4600 0000	213946
LKI 2139 2800 0000	213928
LKI 2177 0500 0000	217705
LKI 8000 2700 0000	
LKI 8000 2800 0000	
LKI 2207 8900 0000	220789

* Standardized length 1 × 500 m
 Further designs upon request

Cable type	Contruction n × mm ²	Core function	Outer Ø mm	Weight kg / km	Cu factor kg / km	Order no.	
						Germany	Switzerland
NHXX-J FE180/E30-E60	3 × 120 RM	LNPE	42.7	4600	3456		
NHXX-J FE180/E30-E60	3 × 150 RM	LNPE	47.3	5400	4320		
NHXX-J FE180/E30-E60	3 × 185 RM	LNPE	52.4	6200	5328		
NHXX-J FE180/E30-E60	3 × 25 + 16 RM	3LPE	25.2	1505	874	LKI 8000 3300 0000	
NHXX-J FE180/E30-E60	3 × 35 + 16 RM	3LPE	27.4	1850	1162	LKI 8000 3400 0000	
NHXX-J FE180/E30-E60	3 × 50 + 25 RM	3LPE	32.1	2490	1680	LKI 8000 3500 0000	
NHXX-J FE180/E30-E60	3 × 70 + 35 RM	3LPE	36.4	3389	2352	LKI 8000 3600 0000	
NHXX-J FE180/E30-E60	3 × 95 + 50 RM	3LPE	41.0	4529	3216	LKI 8000 3800 0000	
NHXX-J FE180/E30-E60	3 × 120 + 70 RM	3LPE	45.6	5562	4128	LKI 8000 3900 0000	
NHXX-J FE180/E30-E60	3 × 150 + 70 RM	3LPE	49.5	6918	4992	LKI 8000 4000 0000	
NHXX-J FE180/E30-E60	3 × 185 + 95 RM	3LPE	54.2	7351	6240	LKI 8000 4100 0000	
NHXX-J FE180/E30-E60	3 × 240 + 120 RM	3LPE	61.3	9810	8064		
NHXX-J FE180/E30-E60	4 × 1.5 RE	3LPE	13.4	212	58	LKI 1912 2800 0000	191228
NHXX-J FE180/E30-E60	4 × 2.5 RE	3LPE	14.4	275	96	LKI 1912 3300 0000	191233
NHXX-J FE180/E30-E60	4 × 4 RE	3LPE	15.0	339	154	LKI 2137 0600 0000	213706
NHXX-J FE180/E30-E60	4 × 6 RE	3LPE	16.2	427	230	LKI 1912 3600 0000	191236
NHXX-J FE180/E30-E60	4 × 10 RE	3LPE	18.0	592	384	LKI 1912 3800 0000	191238
NHXX-J FE180/E30-E60	4 × 16 RM	3LPE	22.1	903	614	LKI 1912 4000 0000	191240
NHXX-J FE180/E30-E60	4 × 25 RM	3LPE	26.0	1381	960	LKI 1912 4200 0000	191242
NHXX-J FE180/E30-E60	4 × 35 RM	3LPE	28.8	1790	1344	LKI 1912 4400 0000	191244
NHXX-J FE180/E30-E60	4 × 50 RM	3LPE	33.2	2485	1920	LKI 2144 7400 0000	214474
NHXX-J FE180/E30-E60	4 × 70 RM	3LPE	37.7	3321	2688	LKI 2177 0600 0000	217706
NHXX-J FE180/E30-E60	4 × 95 RM	3LPE	43.2	4437	3648	LKI 2176 1600 0000	217616
NHXX-J FE180/E30-E60	4 × 120 RM	3LPE	47.8	5610	4608	LKI 2205 0600 0000	220506
NHXX-J FE180/E30-E60	4 × 150 RM	3LPE	52.8	6914	5760	LKI 8000 4400 0000	217617
NHXX-J FE180/E30-E60	4 × 185 RM	3LPE	58.4	8890	7104	LKI 8000 4500 0000	
NHXX-J FE180/E30-E60	4 × 240 RM	3LPE	65.7	10960	9216	LKI 8000 4600 0000	220068
NHXX-J FE180/E30-E60	5 × 1.5 RE	3LNPE	14.6	268	72	LKI 1912 2900 0000	191229
NHXX-J FE180/E30-E60	5 × 2.5 RE	3LNPE	15.7	336	120	LKI 1912 3400 0000	191234
NHXX-J FE180/E30-E60	5 × 4 RE	3LNPE	16.2	411	192	LKI 1912 3500 0000	191235
NHXX-J FE180/E30-E60	5 × 6 RE	3LNPE	17.7	545	288	LKI 1912 3700 0000	191237
NHXX-J FE180/E30-E60	5 × 10 RE	3LNPE	20.0	739	480	LKI 1912 3900 0000	191239
NHXX-J FE180/E30-E60	5 × 16 RM	3LNPE	24.3	1123	768	LKI 1912 4100 0000	191241
NHXX-J FE180/E30-E60	5 × 25 RM	3LNPE	28.8	1657	1200	LKI 1912 4300 0000	191243
NHXX-J FE180/E30-E60	5 × 35 RM	3LNPE	32.2	2231	1680	LKI 1912 4500 0000	191245
NHXX-J FE180/E30-E60	5 × 50 RM	3LNPE	37.5	3015	2400	LKI 2138 6100 0000	213861
NHXX-J FE180/E30-E60	5 × 70 RM	3LNPE	42.2	4101	3360	LKI 3012 7300 0000	301273
NHXX-J FE180/E30-E60	5 × 95 RM	3LNPE	48.1	5544	4560	LKI 2126 5900 0000	212659
NHXX-J FE180/E30-E60	5 × 120 RM	3LNPE	53.7	7300	5760	LKI 8000 5100 0000	
NHXX-J FE180/E30-E60	7 × 1.5 RE	NRPE	16.1	334	101	LKI 1912 3000 0000	191230
NHXX-J FE180/E30-E60	7 × 2.5 RE	NRPE	17.3	422	168	LKI 2144 7300 0000	214473
NHXX-J FE180/E30-E60	7 × 4 RE	NRPE	17.5	520	269	LKI 8000 5200 0000	
NHXX-J FE180/E30-E60	12 × 1.5 RE	NRPE	20.5	520	173	LKI 1912 3100 0000	191231
NHXX-J FE180/E30-E60	12 × 2.5 RE	NRPE	22.2	661	288	LKI 3031 9300 0000	303193
NHXX-J FE180/E30-E60	19 × 1.5 RE	NRPE	23.9	755	274	LKI 8000 6400 0000	
NHXX-J FE180/E30-E60	19 × 2.5 RE	NRPE	25.9	1186	456	LKI 8000 6500 0000	
NHXX-J FE180/E30-E60	24 × 1.5 RE	NRPE	27.7	961	346	LKI 2139 6000 0000	213960
NHXX-J FE180/E30-E60	24 × 2.5 RE	NRPE	30.1	1255	576	LKI 8000 6800 0000	
NHXX-J FE180/E30-E60	30 × 1.5 RE	NRPE	29.6	1105	432	LKI 8000 6900 0000	304412
NHXX-J FE180/E30-E60	30 × 2.5 RE	NRPE	32.4	1522	720	LKI 8000 7000 0000	304413

-J = with gn/ye conductor ●
 -O = without gn/ye conductor
 RE = round solid, class 1
 RM = round stranded, class 2

L = colour phase conductor br/bk/gr ● ● ●
 N = colour neutral conductor bl ●
 NR = colour phase conductors bk ● / numbered
 PE = colour earth conductor gn/ye ●

BETAflam® Safety cables

DIN VDE 0266

DIN



REACH

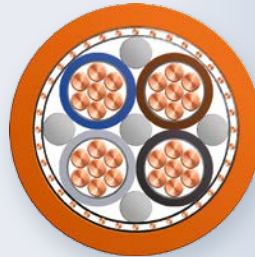
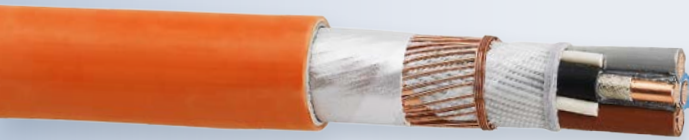

Advantages

- Very high safety standards
- System circuit integrity acc. to DIN 4102 part 12
- DIN approved with LEONI BETAfixss® cable support system
- Halogen-free
- In compliance with REACH directive
- One source for cables and laying system

BETAflam® NHXCH FE180 / E30-E60

Applications

Power cable 0,6 / 1 kV with concentric conductor for fixed installation in cable systems with improved fire performance and system circuit integrity acc. to DIN 4102 part 12, e.g. for:

- lighting of escape routes
- fire alarm systems
- smoke exhaust systems
- recommended in areas where people gather and for protection of valuables

Construction

■ Conductors	Bare annealed copper
■ Flame barrier	MICA tape
■ Insulation	BETAflam® cross-linked
■ Inner covering	Tape or filler
■ conc. conductor	Copper wires, with helix of copper tape
■ Sheath	BETAflam® copolymer
■ Core identification	acc. to VDE 0266 resp. HD 308 S2
■ Sheath colour	Orange

Electrical characteristics

Rated voltage	U_0/U 0,6 / 1 kV
Test voltage	4 kV with 50 Hz

Thermal characteristics

Operation temperature	- 30 °C up to + 90 °C
Laying temperature	- 5 °C up to + 70 °C
Short circuit temperature (temperature peak < 5 s)	up to + 250 °C

Bending radius

cable design	single core	multiple core
during laying	$> 15 \times \text{outer } \emptyset$	$> 12 \times \text{outer } \emptyset$
fixed	$> 8 \times \text{outer } \emptyset$	$> 7 \times \text{outer } \emptyset$

Laying conditions

- Fixed installation indoor, in air or concrete
- Laying in earth or water only in water-proof dry tubes
- Outdoor laying only when protected from direct sunlight and other external impacts

Standards / Material properties

- Halogen-free: IEC 60754-1, EN 50267-2-1, VDE 0482-267-2-1
- No corrosive gases: IEC 60754-2, EN 50267-2-2, VDE 0482-267-2-2
- No toxic gases: NF X 70-100
- Low smoke density: IEC 61034-1 and -2, EN 61034-1 and -2, VDE 0482-1034-1 and -2
- Flame retardant: IEC 60332-1, EN 60332-1, VDE 0482-332-1
- No flame propagation: IEC 60332-3-10 and -3-24, EN 60332-3-10, -24, VDE 0482-332-3-24
- Circuit integrity FE180: IEC 60331-11 and -21, VDE 0472-814
- Circuit integrity with shock: EN 50200 PH90 (bis \emptyset 20 mm)
- System circuit integrity: DIN 4102-12, E30 or E60, depending on laying system

Cable type	Construction n × mm ²	Core function	Outer Ø mm	Weight kg/km	Cu factor kg/km	Order no.	
						Germany	Switzerland
NHXCH FE180/E30-E60	2 × 1.5 RE/1.5	LN	14.8	287	52	LKI 8001 6700 0000	
NHXCH FE180/E30-E60	2 × 2.5 RE/2.5	LN	15.6	331	80	LKI 8001 6800 0000	305103
NHXCH FE180/E30-E60	2 × 4 RE/4	LN	16.1	408	123	LKI 8001 6900 0000	305104
NHXCH FE180/E30-E60	2 × 6 RE/6	LN	17.2	463	182	LKI 8001 7000 0000	
NHXCH FE180/E30-E60	2 × 10 RE/10	LN	18.7	643	312	LKI 8001 7100 0000	
NHXCH FE180/E30-E60	3 × 1.5 RE/1.5	3L	15.7	392	66	LKI 2177 2700 0000	217727
NHXCH FE180/E30-E60	3 × 2.5 RE/2.5	3L	17.2	430	104	LKI 2177 3000 0000	217730
NHXCH FE180/E30-E60	3 × 4 RE/4	3L	17.5	510	161	LKI 8001 7600 0000	
NHXCH FE180/E30-E60	3 × 6 RE/6	3L	17.7	600	240	LKI 8001 7700 0000	
NHXCH FE180/E30-E60	3 × 10 RE/10	3L	19.9	736	408	LKI 8001 7800 0000	
NHXCH FE180/E30-E60	3 × 16 RM/16	3L	23.6	1161	643	LKI 8001 7900 0000	
NHXCH FE180/E30-E60	3 × 25 RM/16	3L	27.3	1707	902	LKI 8001 8000 0000	
NHXCH FE180/E30-E60	3 × 35 RM/16	3L	29.5	2190	1190	LKI 8001 8100 0000	
NHXCH FE180/E30-E60	3 × 50 RM/25	3L	34.3	3646	1728	LKI 8001 8200 0000	
NHXCH FE180/E30-E60	3 × 70 RM/35	3L	38.2	4042	2415	LKI 8001 8300 0000	
NHXCH FE180/E30-E60	3 × 95 RM/50	3L	46.2	5134	3296	LKI 8001 8400 0000	303537
NHXCH FE180/E30-E60	3 × 120 RM/70	3L	47.2	6300	4236	LKI 8001 8500 0000	
NHXCH FE180/E30-E60	3 × 150 RM/70	3L	51.8	7020	5100	LKI 8001 8600 0000	
NHXCH FE180/E30-E60	3 × 185 RM/95	3L	57.2	8378	6383	LKI 3004 0900 0000	300409
NHXCH FE180/E30-E60	3 × 240 RM/120	3L	64.2	11323	8242	LKI 8001 8700 0000	
NHXCH FE180/E30-E60	4 × 1.5 RE/1.5	3LN	17.2	332	81	LKI 2172 4400 0000	217244
NHXCH FE180/E30-E60	4 × 2.5 RE/2.5	3LN	17.3	358	128	LKI 8001 9500 0000	303890
NHXCH FE180/E30-E60	4 × 4 RE/4	3LN	17.7	516	200	LKI 2139 4200 0000	213942
NHXCH FE180/E30-E60	4 × 6 RE/6	3LN	18.5	612	297	LKI 3005 5800 0000	300558
NHXCH FE180/E30-E60	4 × 10 RE/10	3LN	22.0	879	504	LKI 2139 6300 0000	213963
NHXCH FE180/E30-E60	4 × 16 RM/16	3LN	25.6	1196	796	LKI 2139 6400 0000	213964
NHXCH FE180/E30-E60	4 × 25 RM/16	3LN	27.7	1654	1142	LKI 2139 6500 0000	213965
NHXCH FE180/E30-E60	4 × 35 RM/16	3LN	30.3	2113	1526	LKI 2139 6600 0000	213966
NHXCH FE180/E30-E60	4 × 50 RM/25	3LN	35.2	2774	2203	LKI 2139 6700 0000	213967
NHXCH FE180/E30-E60	4 × 70 RM/35	3LN	39.5	3833	3082	LKI 2139 6800 0000	213968
NHXCH FE180/E30-E60	4 × 95 RM/50	3LN	45.8	5216	4208	LKI 2139 6900 0000	213969
NHXCH FE180/E30-E60	4 × 120 RM/70	3LN	50.4	6519	5388	LKI 2139 7000 0000	213970
NHXCH FE180/E30-E60	4 × 150 RM/70	3LN	55.4	7849	6540	LKI 2139 7100 0000	213971
NHXCH FE180/E30-E60	4 × 185 RM/95	3LN	61.6	9769	8159	LKI 2139 7200 0000	213972
NHXCH FE180/E30-E60	4 × 240 RM/120	3LN	69.0	12983	10546	LKI 3004 7000 0000	300470
NHXCH FE180/E30-E60	7 × 1.5 RE/2.5	NR	18.7	412	133	LKI 8001 9600 0000	
NHXCH FE180/E30-E60	7 × 2.5 RE/2.5	NR	18.3	488	200	LKI 8001 9700 0000	
NHXCH FE180/E30-E60	12 × 1.5 RE/2.5	NR	21.5	612	205	LKI 2177 3600 0000	217736
NHXCH FE180/E30-E60	12 × 2.5 RE/4	NR	25.3	780	334	LKI 8002 0200 0000	305565
NHXCH FE180/E30-E60	24 × 1.5 RE/6	NR	28.5	1052	413	LKI 8002 1100 0000	
NHXCH FE180/E30-E60	24 × 2.5 RE/10	NR	30.4	1398	696	LKI 8002 1200 0000	

RE = round solid, class 1
RM = round stranded, class 2

L = colour phase conductor br/bk/gr ● ● ●
N = colour neutral conductor bl ●
NR = colour phase conductors bk ● / numbered

BETAflam® Safety cables

DIN VDE 0266

DIN



REACH

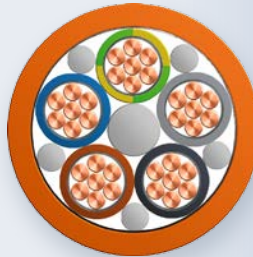

Advantages

- Very high safety standards
- System circuit integrity acc. to DIN 4102 part 12
- DIN approved with LEONI BETAfixss® cable support system
- Halogen-free
- In compliance with REACH directive

BETAflam® NHXH FE180 / E90

Applications

Power cable 0,6/1 kV for fixed installation in cable systems with improved fire performance and system circuit integrity acc. to DIN 4102 part 12, e.g. for:

- water pumps for fire fighting
- smoke exhaust systems etc.
- recommended in areas where people gather and for protection of valuables

Construction

■ Conductors	Bare annealed copper
■ Flame barrier	MICA tape
■ Insulation	BETAflam® cross-linked
■ Inner covering	Tape or filler
■ Sheath	BETAflam® copolymer
■ Core identification	acc. to VDE 0266 resp. HD 308 S2
■ Sheath colour	Orange

Electrical characteristics

Rated voltage	U ₀ /U 0.6 / 1 kV
Test voltage	4 kV with 50 Hz

Thermal characteristics

Operation temperature	-30 °C up to +90 °C
Laying temperature	-5 °C up to +70 °C
Short circuit temperature (temperature peak < 5 s)	up to +250 °C

Bending radius

cable design	single core	multiple core
during laying	> 15 × outer Ø	>12 × outer Ø
fixed	> 8 × outer Ø	>7 × outer Ø

Laying conditions

- Fixed installation indoor, in air or concrete
- Laying in earth or water only in water-proof dry tubes
- Outdoor laying only when protected from direct sunlight and other external impacts

Standards / Material properties

- Halogen-free: IEC 60754-1, EN 50267-2-1, VDE 0482-267-2-1
- No corrosive gases: IEC 60754-2, EN 50267-2-2, VDE 0482-267-2-2
- No toxic gases: NF X 70-100
- Low smoke density: IEC 61034-1 and -2, EN 61034-1 and -2, VDE 0482-1034-1 and -2
- Flame retardant: IEC 60332-1, EN 60332-1, VDE 0482-332-1
- No flame propagation: IEC 60332-3-10 and -3-24, EN 60332-3-10, -24, VDE 0482-332-3-24
- Circuit integrity FE180: IEC 60331-11 and -21, VDE 0472-814
- Circuit integrity with shock: EN 50200 PH 90 (up to Ø 20 mm) and EN 50362 P 90 (>20 mm up to Ø 45 mm)
- System circuit integrity: DIN 4102-12 E90, depending on laying system
- Water extinguishing systems: VdS ≥ 2.5 mm²

Cable type	Construction n × mm ²	Core function	Outer Ø mm	Weight kg / km	Cu factor kg / km	Order no.	
						Germany	Switzerland
NHXX-J FE180 / E90	1 × 10 RE	PE	9.5	178	96	LKI 8002 1700 0000	
NHXX-J FE180 / E90	1 × 16 RM	PE	10.9	271	154	LKI 8002 1800 0000	
NHXX-J FE180 / E90	1 × 25 RM	PE	12.5	360	240	LKI 2187 8300 0000	218783
NHXX-J FE180 / E90	1 × 35 RM	PE	13.6	478	336	LKI 8002 1900 0000	305400
NHXX-J FE180 / E90	1 × 50 RM	PE	15.2	630	480	LKI 8002 2000 0000	
NHXX-J FE180 / E90	1 × 70 RM	PE	17.0	841	672	LKI 8002 2100 0000	305403
NHXX-J FE180 / E90	1 × 95 RM	PE	19.4	1128	912	LKI 8002 2200 0000	305401
NHXX-J FE180 / E90	1 × 120 RM	PE	21.2	1389	1152	LKI 8002 2300 0000	
NHXX-J FE180 / E90	1 × 150 RM	PE	23.2	1681	1440	LKI 8002 2400 0000	306264
NHXX-J FE180 / E90	1 × 185 RM	PE	25.6	2070	1776	LKI 8002 2500 0000	303473
NHXX-J FE180 / E90	1 × 240 RM	PE	28.6	2678	2304	LKI 2255 5100 0000	225551
NHXX-J FE180 / E90	1 × 300 RM	PE	32.9	3478	2880	LKI 8002 2600 0000	304198
NHXX-J FE180 / E90	1 × 400 RM	PE	36.6	4381	3840	LKI 8002 2700 0000	304931
NHXX-J FE180 / E90	1 × 500 RM	PE	40.6	5500	4800	LKI 8002 2800 0000	
NHXX-O FE180 / E90	1 × 10 RE	L	9.5	178	96	LKI 8002 7400 0000	
NHXX-O FE180 / E90	1 × 16 RM	L	10.9	271	154	LKI 3006 6700 0000	300667
NHXX-O FE180 / E90	1 × 25 RM	L	12.5	360	240	LKI 2255 3900 0000	225539
NHXX-O FE180 / E90	1 × 35 RM	L	13.6	478	336	LKI 2255 4000 0000	225540
NHXX-O FE180 / E90	1 × 50 RM	L	15.2	630	480	LKI 2255 1300 0000	225513
NHXX-O FE180 / E90	1 × 70 RM	L	17.0	841	672	LKI 2255 1600 0000	225516
NHXX-O FE180 / E90	1 × 95 RM	L	19.4	1128	912	LKI 2255 1800 0000	225518
NHXX-O FE180 / E90	1 × 120 RM	L	21.2	1389	1152	LKI 2255 2000 0000	225520
NHXX-O FE180 / E90	1 × 150 RM	L	23.2	1681	1440	LKI 2255 2100 0000	225521
NHXX-O FE180 / E90	1 × 185 RM	L	25.6	2070	1776	LKI 2255 2200 0000	225522
NHXX-O FE180 / E90	1 × 240 RM	L	28.6	2678	2304	LKI 2255 2300 0000	225523
NHXX-O FE180 / E90	1 × 300 RM	L	32.9	3478	2880	LKI 2255 5300 0000	225553
NHXX-O FE180 / E90	1 × 400 RM	L	36.6	4381	3840	LKI 8002 7500 0000	304930
NHXX-O FE180 / E90	1 × 500 RM	L	40.6	5500	4800	LKI 8002 7600 0000	
NHXX-O FE180 / E90	2 × 1.5 RE	LN	12.4	200	29	LKI 3012 1400 0000	301214
NHXX-O FE180 / E90	2 × 2.5 RE	LN	13.8	231	48	LKI 8002 7700 0000	307085
NHXX-O FE180 / E90	2 × 4 RE	LN	14.2	273	77	LKI 8002 7800 0000	305397
NHXX-O FE180 / E90	2 × 6 RE	LN	15.1	345	115	LKI 3026 2800 0000	302628
NHXX-O FE180 / E90	2 × 10 RE	LN	17.4	443	192	LKI 8002 7900 0000	
NHXX-O FE180 / E90	2 × 16 RM	LN	20.2	654	307	LKI 8002 8000 0000	
NHXX-O FE180 / E90	2 × 25 RM	LN	23.4	909	480	LKI 8002 8100 0000	
NHXX-J FE180 / E90	3 × 1.5 RE	LNPE	13.1	214	43	LKI 2254 8200 0000	225482
NHXX-J FE180 / E90	3 × 2.5 RE	LNPE	13.9	258	72	LKI 2254 9000 0000	225490
NHXX-J FE180 / E90	3 × 4 RE	LNPE	15.0	319	115	LKI 2254 9500 0000	225495
NHXX-J FE180 / E90	3 × 6 RE	LNPE	15.9	389	173	LKI 2254 9900 0000	225499
NHXX-J FE180 / E90	3 × 10 RE	LNPE	17.4	529	288	LKI 2255 0200 0000	225502
NHXX-J FE180 / E90	3 × 16 RM	LNPE	21.5	829	461	LKI 2255 0500 0000	225505
NHXX-J FE180 / E90	3 × 25 RM	LNPE	24.9	1184	720	LKI 2255 0800 0000	225508
NHXX-J FE180 / E90	3 × 35 RM	LNPE	27.3	1447	1008	LKI 2255 4100 0000	225541
NHXX-J FE180 / E90	3 × 50 RM	LNPE	30.9	2020	1440	LKI 3021 5600 0000	302156
NHXX-J FE180 / E90	3 × 70 RM	LNPE	34.8	2693	2016	LKI 3021 5700 0000	302157
NHXX-J FE180 / E90	3 × 95 RM	LNPE	39.9	3623	2736	LKI 3021 5800 0000	302158
NHXX-J FE180 / E90	3 × 120 RM	LNPE	43.8	4521	3456	LKI 8002 3800 0000	
NHXX-J FE180 / E90	3 × 150 RM	LNPE	48.5	5525	4320	LKI 8002 3900 0000	
NHXX-J FE180 / E90	3 × 185 RM	LNPE	53.4	6799	5328	LKI 8002 4000 0000	
NHXX-J FE180 / E90	3 × 240 RM	LNPE	59.9	8137	6912	LKI 8002 4100 0000	

-J = with gn/ye conductor ●
 -O = without gn/ye conductor
 RE = round solid, class 1
 RM = round stranded, class 2

L = colour phase conductor br/bk/gr ●●●
 N = colour neutral conductor bl ●
 NR = colour phase conductors bk●/numbered
 PE = colour earth conductor gn/ye ●

Further designs upon request

Cable type	Construction n × mm ²	Core function	Outer Ø mm	Weight kg/km	Cu factor kg/km	Order no.	
						Germany	Switzerland
NHXXH-J FE180/E90	3 × 35 + 1 × 16 RM	3LPE	29.0	1804	1162	LKI 3007 4100 0000	300741
NHXXH-J FE180/E90	3 × 50 + 1 × 25 RM	3LPE	33.3	2387	1680	LKI 3007 4200 0000	300742
NHXXH-J FE180/E90	3 × 70 + 1 × 35 RM	3LPE	37.2	3193	2352	LKI 3007 4300 0000	300743
NHXXH-J FE180/E90	3 × 95 + 1 × 50 RM	3LPE	44.0	4831	3216	LKI 8002 4300 0000	
NHXXH-J FE180/E90	3 × 120 + 1 × 70 RM	3LPE	47.0	5903	4128	LKI 8002 4400 0000	
NHXXH-J FE180/E90	3 × 150 + 1 × 70 RM	3LPE	51.0	7064	4992	LKI 8002 4500 0000	
NHXXH-J FE180/E90	3 × 185 + 1 × 95 RM	3LPE	57.0	8600	6240	LKI 8002 4600 0000	
NHXXH-J FE180/E90	3 × 240 + 1 × 120 RM	3LPE	67.4	10266	8064	LKI 2255 5200 0000	225552
NHXXH-J FE180/E90	3 × 300 + 1 × 150 RM	3LPE	77.0	13545	10080	LKI 8002 4700 0000	
NHXXH-J FE180/E90	4 × 1.5 RE	3LPE	14.2	267	58	LKI 2254 8500 0000	225485
NHXXH-J FE180/E90	4 × 2.5 RE	3LPE	15.2	323	96	LKI 2254 9100 0000	225491
NHXXH-J FE180/E90	4 × 4 RE	3LPE	16.4	404	154	LKI 2254 9600 0000	225496
NHXXH-J FE180/E90	4 × 6 RE	3LPE	17.5	497	230	LKI 2255 0000 0000	225500
NHXXH-J FE180/E90	4 × 10 RE	3LPE	19.1	683	384	LKI 2255 0300 0000	225503
NHXXH-J FE180/E90	4 × 16 RM	3LPE	23.6	1009	614	LKI 2255 0600 0000	225506
NHXXH-J FE180/E90	4 × 25 RM	3LPE	27.4	1536	960	LKI 2255 0900 0000	225509
NHXXH-J FE180/E90	4 × 35 RM	3LPE	30.4	1966	1344	LKI 2255 1100 0000	225511
NHXXH-J FE180/E90	4 × 50 RM	3LPE	34.2	2589	1920	LKI 2255 1400 0000	225514
NHXXH-J FE180/E90	4 × 70 RM	3LPE	38.6	3512	2688	LKI 2255 1700 0000	225517
NHXXH-J FE180/E90	4 × 95 RM	3LPE	44.6	4684	3648	LKI 2255 1900 0000	225519
NHXXH-J FE180/E90	4 × 120 RM	3LPE	48.9	5734	4608	LKI 2255 4800 0000	225548
NHXXH-J FE180/E90	4 × 150 RM	3LPE	53.6	6974	5760	LKI 2255 4900 0000	225549
NHXXH-J FE180/E90	4 × 185 RM	3LPE	59.4	8986	7104	LKI 3021 5900 0000	302159
NHXXH-J FE180/E90	4 × 240 RM	3LPE	67.6	11385	9216	LKI 3021 0200 0000	302102
NHXXH-J FE180/E90	5 × 1.5 RE	3LNPE	15.4	325	72	LKI 2254 8600 0000	225486
NHXXH-J FE180/E90	5 × 2.5 RE	3LNPE	16.4	393	120	LKI 2254 9200 0000	225492
NHXXH-J FE180/E90	5 × 4 RE	3LNPE	17.9	498	192	LKI 2254 9700 0000	225497
NHXXH-J FE180/E90	5 × 6 RE	3LNPE	19.1	623	288	LKI 2255 0100 0000	225501
NHXXH-J FE180/E90	5 × 10 RE	3LNPE	20.8	852	480	LKI 2255 0400 0000	225504
NHXXH-J FE180/E90	5 × 16 RM	3LNPE	26.0	1263	768	LKI 2255 0700 0000	225507
NHXXH-J FE180/E90	5 × 25 RM	3LNPE	30.6	1823	1200	LKI 2255 1000 0000	225510
NHXXH-J FE180/E90	5 × 35 RM	3LNPE	33.5	2467	1680	LKI 2255 1200 0000	225512
NHXXH-J FE180/E90	5 × 50 RM	3LNPE	38.4	3226	2400	LKI 2255 4300 0000	225543
NHXXH-J FE180/E90	5 × 70 RM	3LNPE	43.2	4273	3360	LKI 8002 5000 0000	311196
NHXXH-J FE180/E90	5 × 95 RM	3LNPE	50.0	6184	4560	LKI 8002 5100 0000	311197
NHXXH-J FE180/E90	7 × 1.5 RE	NRPE	16.4	402	101	LKI 2254 8700 0000	225487
NHXXH-J FE180/E90	7 × 2.5 RE	NRPE	17.6	497	168	LKI 2254 9300 0000	225493
NHXXH-J FE180/E90	7 × 4 RE	NRPE	19.1	633	269	LKI 2254 9800 0000	225498
NHXXH-J FE180/E90	10 × 1.5 RE	NRPE	22.5	664	144	LKI 2254 8700 0000	
NHXXH-J FE180/E90	10 × 2.5 RE	NRPE	24.1	798	240	LKI 2254 9300 0000	
NHXXH-J FE180/E90	12 × 1.5 RE	NRPE	21.2	640	173	LKI 2254 9800 0000	225489
NHXXH-J FE180/E90	12 × 2.5 RE	NRPE	22.9	801	288	LKI 2254 9400 0000	225494
NHXXH-J FE180/E90	24 × 1.5 RE	NRPE	28.6	1193	346	LKI 2255 3500 0000	225535
NHXXH-J FE180/E90	24 × 2.5 RE	NRPE	33.2	1576	576	LKI 8002 6500 0000	
NHXXH-J FE180/E90	30 × 1.5 RE	NRPE	32.6	1398	432	LKI 8002 6700 0000	

-J = with gn/ye conductor ●
-O = without gn/ye conductor
RE = round solid, class 1
RM = round stranded, class 2

L = colour phase conductor br/bk/gr ● ● ●
N = colour neutral conductor bl ●
NR = colour phase conductors bk ● / numbered
PE = colour earth conductor gn/ye ●

Further designs upon request

BETAflam® Safety cables

DIN VDE 0266



REACH

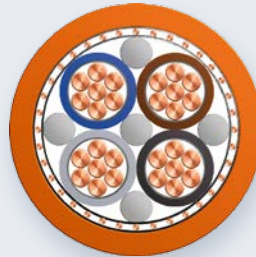

Advantages

- Very high safety standards
- System circuit integrity acc. to DIN 4102 part 12
- DIN approved with LEONI BETAfixs® cable support system
- Halogen-free
- In compliance with REACH directive

BETAflam® NHXCH FE180 / E90

Applications

Power cable 0,6 / 1 kV with concentric conductor for fixed installation in cable systems with improved fire performance and system circuit integrity acc. to DIN 4102 Teil 12, e.g. for:

- water pumps for fire fighting
- smoke exhaust systems etc.
- recommended in areas where people gather and for protection of valuables

Construction

■ Conductors	Bare annealed copper
■ Flame barrier	MICA tape
■ Insulation	BETAflam® cross-linked
■ Inner covering	Tape or filler
■ conc. conductor	Copper wires, with helix of copper tape
■ Sheath	BETAflam® copolymer
■ Core identification	acc. to VDE 0266 resp. HD 308 S2
■ Sheath colour	Orange

Electrical characteristics

Rated voltage	U_0/U 0.6 / 1 kV
Test voltage	4 kV with 50 Hz

Thermal characteristics

Operation temperature	-30 °C up to +90 °C
Laying temperature	-5 °C up to +70 °C
Short circuit temperature (temperature peak < 5 s)	up to +250 °C

Bending radius

cable design	single core	multiple core
during laying	$> 15 \times \text{outer } \varnothing$	$> 12 \times \text{outer } \varnothing$
fixed	$> 8 \times \text{outer } \varnothing$	$> 7 \times \text{outer } \varnothing$

Laying conditions

- Fixed installation indoor, in air or concrete
- Laying in earth or water only in water-proof dry tubes
- Outdoor laying only when protected from direct sunlight and other external impacts

Standards / Material properties

- Halogen-free: IEC 60754-1, EN 50267-2-1, VDE 0482-267-2-1
- No corrosive gases: IEC 60754-2, EN 50267-2-2, VDE 0482-267-2-2
- No toxic gases: NF X 70-100
- Low smoke density: IEC 61034-1 and -2, EN 61034-1 and -2, VDE 0482-1034-1 and -2
- Flame retardant: IEC 60332-1, EN 60332-1, VDE 0482-332-1
- No flame propagation: IEC 60332-3-10 and -3-24, EN 60332-3-10, -24, VDE 0482-332-3-24
- Circuit integrity FE180: IEC 60331-11 and -21, VDE 0472-814
- Circuit integrity with shock: EN 50200 PH90 (up to \varnothing 20 mm)
- System circuit integrity: DIN 4102-12 E90, depending on laying system
- Water extinguishing systems: $VdS \geq 2.5 \text{ mm}^2$

Cable type	Construction n × mm ²	Core function	Outer Ø mm	Weight kg / km	Cu factor kg / km	Order no.	
						Germany	Switzerland
NHXCH FE180 / E90	2 × 1.5 RE/1.5	LN	15.0	268	52	LKI 8003 6100 0000	306934
NHXCH FE180 / E90	2 × 2.5 RE/2.5	LN	15.8	312	80	LKI 8003 6200 0000	306935
NHXCH FE180 / E90	2 × 4 RE/4	LN	17.9	451	123	LKI 8003 6400 0000	
NHXCH FE180 / E90	2 × 6 RE/6	LN	18.6	539	182	LKI 8003 6500 0000	
NHXCH FE180 / E90	2 × 10 RE/10	LN	20.4	679	312	LKI 8003 6600 0000	
NHXCH FE180 / E90	3 × 1.5 RE/1.5	3L	15.7	394	66	LKI 30322200 0000	303222
NHXCH FE180 / E90	3 × 2.5 RE/2.5	3L	17.4	423	104	LKI 8003 7000 0000	303928
NHXCH FE180 / E90	3 × 4 RE/4	3L	18.7	511	161	LKI 8003 7200 0000	
NHXCH FE180 / E90	3 × 6 RE/6	3L	19.7	601	240	LKI 8003 7300 0000	
NHXCH FE180 / E90	3 × 10 RE/10	3L	21.3	916	408	LKI 2255 5900 0000	225559
NHXCH FE180 / E90	3 × 16 RM/16	3L	24.9	1201	643	LKI 3033 3700 0000	303337
NHXCH FE180 / E90	3 × 25 RM/16	3L	28.3	1484	902	LKI 3033 3800 0000	303338
NHXCH FE180 / E90	3 × 35 RM/16	3L	30.9	1848	1190	LKI 8003 7600 0000	307071
NHXCH FE180 / E90	3 × 50 RM/25	3L	35.4	2358	1728	LKI 8003 7800 0000	304194
NHXCH FE180 / E90	3 × 70 RM/35	3L	38.5	3161	2415	LKI 8003 8000 0000	
NHXCH FE180 / E90	3 × 95 RM/50	3L	44.3	4427	3296	LKI 8003 8200 0000	307072
NHXCH FE180 / E90	3 × 120 RM/70	3L	48.2	5323	4236	LKI 8003 8400 0000	
NHXCH FE180 / E90	3 × 150 RM/70	3L	52.9	6286	5100	LKI 3032 3900 0000	303239
NHXCH FE180 / E90	3 × 185 RM/95	3L	58.4	7636	6383	LKI 8003 8500 0000	
NHXCH FE180 / E90	3 × 240 RM/120	3L	65.3	9714	8242	LKI 8003 8600 0000	
NHXCH FE180 / E90	4 × 1.5 RE/1.5	3LN	17.2	332	81	LKI 2255 5400 0000	225554
NHXCH FE180 / E90	4 × 2.5 RE/2.5	3LN	18.2	481	128	LKI 2255 5600 0000	225556
NHXCH FE180 / E90	4 × 4 RE/4	3LN	18.4	601	200	LKI 2255 5700 0000	
NHXCH FE180 / E90	4 × 6 RE/6	3LN	18.5	841	297	LKI 2255 5800 0000	225558
NHXCH FE180 / E90	4 × 10 RE/10	3LN	22.0	879	504	LKI 2255 2400 0000	225524
NHXCH FE180 / E90	4 × 16 RM/16	3LN	25.2	1262	796	LKI 2255 2500 0000	225525
NHXCH FE180 / E90	4 × 25 RM/16	3LN	29.0	1786	1142	LKI 2255 2600 0000	225526
NHXCH FE180 / E90	4 × 35 RM/16	3LN	31.9	2375	1526	LKI 2255 2700 0000	225527
NHXCH FE180 / E90	4 × 50 RM/25	3LN	36.6	3122	2203	LKI 2255 2800 0000	225528
NHXCH FE180 / E90	4 × 70 RM/35	3LN	40.6	4129	3082	LKI 2255 2900 0000	225529
NHXCH FE180 / E90	4 × 95 RM/50	3LN	47.0	5447	4208	LKI 2255 3000 0000	225530
NHXCH FE180 / E90	4 × 120 RM/70	3LN	51.5	6657	5388	LKI 2255 3100 0000	225531
NHXCH FE180 / E90	4 × 150 RM/70	3LN	56.5	8039	6540	LKI 2255 3200 0000	225532
NHXCH FE180 / E90	4 × 185 RM/95	3LN	63.6	10157	8159	LKI 2255 3300 0000	225533
NHXCH FE180 / E90	4 × 240 RM/120	3LN	70.8	12989	10546	LKI 2255 3400 0000	225534
NHXCH FE180 / E90	7 × 1.5 RE/2.5	NR	18.3	488	133	LKI 8003 9200 0000	
NHXCH FE180 / E90	7 × 2.5 RE/2.5	NR	21.3	576	200	LKI 8003 9300 0000	
NHXCH FE180 / E90	12 × 1.5 RE/2.5	NR	23.8	702	205	LKI 3006 7600 0000	300676
NHXCH FE180 / E90	12 × 2.5 RE/4	NR	25.4	901	334	LKI 8003 9700 0000	304512
NHXCH FE180 / E90	24 × 1.5 RE/6	NR	32.7	1335	413	LKI 8004 0300 0000	305185
NHXCH FE180 / E90	24 × 2.5 RE/10	NR	32.9	1655	696	LKI 2261 4300 0000	226143
NHXCH FE180 / E90	30 × 1.5 RE/6	NR	34.8	1596	499	LKI 8004 0400 0000	
NHXCH FE180 / E90	30 × 2.5 RE/10	NR	38.0	2263	840	LKI 8004 0500 0000	

RE = round solid, class 1
RM = round stranded, class 2

L = colour phase conductor br/bk/gr ● ● ●
N = colour neutral conductor bl ●
NR = colour phase conductors bk ● / numbered

BETAflam® Signal and fire alarm cables

DIN VDE 0815



REACH



Advantages

- Very high safety standards
- System circuit integrity acc. to DIN 4102 part 12
- DIN approved with LEONI BETAfixs® cable support system
- Halogen-free
- In compliance with REACH directive
- Smooth and compact

BETAflam® JE-H(St)H FE180/E30 SIR

Applications

Shielded installation cable for fixed installation in cable systems with improved fire performance and system circuit integrity acc. to DIN 4102 part 12, e.g. for:

- fire alarm systems and signalling etc.
- recommended in areas where people gather and for protection of valuables

Construction

- | | |
|-----------------------|---|
| ■ Conductors | Bare annealed copper |
| ■ Insulation | Silicone |
| ■ Banding | Polyester tape |
| ■ Screen | Aluminium laminated polyester tape with bonding wire 0.8 mm Ø |
| ■ Sheath | BETAflam® copolymer |
| ■ Core identification | acc. to VDE 0815
(bl/rd, gr/ye, gn/br, wt/bk) |
| ■ Sheath colour | Orange or red
(fire alarm cable BMK) |

Electrical characteristics

Operating voltage	225 V peak
Test voltage	0.5 / 2 kV, 50 Hz

Thermal characteristics

Operation temperature	- 30 °C up to + 90 °C
Laying temperature	- 5 °C up to + 50 °C

Bending radius

during laying	> 12 × outer Ø
fixed	> 8 × outer Ø

Laying conditions

- Fixed installation in dry and moist areas
- In or under plaster
- Not suitable in earth or concrete
- Outdoor laying only when protected from direct sunlight and other external impacts

Standards / Material properties

- Halogen-free: IEC 60754-1; EN 50267-2-1; VDE 0482-267-2-1
- No corrosive gases: IEC 60754-2; EN 50267-2-2; VDE 0482-267-2-2
- Low smoke density: IEC 61034-1 and -2; EN 61034-1 and -2; VDE 0482-1034-1 and -2
- Flame retardant: IEC 60332-1; EN 60332-1; VDE 0482-332-1
- No flame propagation: IEC EN 60332-3-10, -3-23 and -3-24; VDE 0482-332-3-10, -332-3-23 und -332-3-24
- Circuit integrity FE180: IEC 60331-11 and -23; VDE 0472-814
- System circuit integrity: DIN 4102-12, E30, depending on laying system

Cable type	Sheath colour	Construction	Outer Ø	Weight	Cu factor	Order no.	
						Germany	Switzerland
		n × 2 × mm	mm	kg / km	kg / km		
JE-H(St)H FE180 / E30 SIR	● Orange	1 × 2 × 0.8	5.8	48	15	LKI 3052 2700 0000	305227
JE-H(St)H FE180 / E30 SIR	● Orange	2 × 2 × 0.8	6.9	67	25	LKI 3052 2800 0000	305228
JE-H(St)H FE180 / E30 SIR	● Orange	4 × 2 × 0.8	10.1	117	45	LKI 3052 2900 0000	305229
JE-H(St)H FE180 / E30 SIR	● Orange	8 × 2 × 0.8	14.2	217	85	LKI 3052 3200 0000	305232
JE-H(St)H FE180 / E30 SIR	● Orange	12 × 2 × 0.8	15.9	286	126	LKI 3052 3300 0000	305233
JE-H(St)H FE180 / E30 SIR	● Orange	20 × 2 × 0.8	20.0	472	206	LKI 3052 3400 0000	305234
JE-H(St)H FE180 / E30 SIR BMK	● Rot	1 × 2 × 0.8	5.8	48	15	LKI 3052 3500 0000	305235
JE-H(St)H FE180 / E30 SIR BMK	● Rot	2 × 2 × 0.8	6.9	67	24	LKI 3052 3600 0000	305236
JE-H(St)H FE180 / E30 SIR BMK	● Rot	4 × 2 × 0.8	10.1	117	45	LKI 3052 3700 0000	305237
JE-H(St)H FE180 / E30 SIR BMK	● Rot	8 × 2 × 0.8	14.2	217	85	LKI 3052 3800 0000	305238
JE-H(St)H FE180 / E30 SIR BMK	● Rot	12 × 2 × 0.8	15.9	286	126	LKI 3052 3900 0000	305239
JE-H(St)H FE180 / E30 SIR BMK	● Rot	20 × 2 × 0.8	20.0	472	206	LKI 3052 4100 0000	305241
JE-H(St)H FE180 / E30 SIR BMK	● Rot	1 × 2 × 1.0 mm ²	7.4	69	24		311712
JE-H(St)H FE180 / E30 SIR BMK	● Rot	1 × 2 × 1.5 mm ²	7.8	86	34		309494

Core identification acc. to VDE 0815: bl/rt ● bl/rt ● gr/ge ● gn/br ● ws/sw

Cables 2 × 2 × 0.8 mm are twisted in Star Quad configuration.

Further designs upon request

BETAflam® Signal and fire alarm cables

DIN VDE 0815



REACH



Advantages

- Very high safety standards
- System circuit integrity acc. to DIN 4102 part 12
- DIN approved with LEONI BETAfixs® cable support system
- Halogen-free
- In compliance with REACH directive

BETAflam® JE-H(St)H FE180 / E30-E90

Applications

Shielded installation cable for fixed installation in cable systems with improved fire performance and system circuit integrity acc. to DIN 4102 part 12, e.g. for:

- fire alarm systems and signalling etc.
- recommended in areas where people gather and for protection of valuables

Construction

- | | |
|-----------------------|---|
| ■ Conductors | Bare annealed copper |
| ■ Flame barrier | MICA tape |
| ■ Insulation | BETAflam® copolymer |
| ■ Banding | Polyester and glass fiber tape |
| ■ Screen | Aluminium laminated polyester tape with bonding wire 0.8 mm Ø |
| ■ Sheath | BETAflam® copolymer |
| ■ Core identification | acc. to VDE 0815
(bl/rd, gr/ye, gn/br, wt/bk) |
| ■ Sheath colour | Orange or red
(fire alarm cable BMK) |

Electrical characteristics

Operating voltage	225 V peak
Test voltage	0.5 / 2 kV, 50 Hz

Thermal characteristics

Operation temperature	-30 °C up to +70 °C
Laying temperature	-5 °C up to +50 °C

Bending radius

during laying	> 12 × outer Ø
fixed	> 8 × outer Ø

Laying conditions

- Fixed installation in dry and moist areas
- In or under plaster
- Not suitable in earth or concrete
- Outdoor laying only when protected from direct sunlight and other external impacts

Standards / Material properties

- Halogen-free: IEC 60754-1, EN 50267-2-1, VDE 0482-267-2-1
- No corrosive gases: IEC 60754-2, EN 50267-2-2, VDE 0482-267-2-2
- No toxic gases: NF X 70-100
- Low smoke density: IEC 61034-1 and -2, EN 61034-1 and -2, VDE 0482-1034-1 and -2
- Flame retardant: IEC 60332-1, EN 60332-1, VDE 0482-332-1
- No flame propagation: IEC 60332-3-10 and -3-24, EN 60332-3-10, -24, VDE 0482-332-3-24
- Circuit integrity FE180: IEC 60331-11 and -23, VDE 0472-814
- Circuit integrity with shock: EN 50200 PH90 (up to Ø 20 mm)
- System circuit integrity: DIN 4102-12, E30, E60, E90, depending on laying system

Cable type	Sheath colour	Construction n×2×mm	Outer Ø mm	Weight kg/km	Cu factor kg/km	Order no.	
						Germany	Switzerland
JE-H(St)H FE180/E30-E90	Orange	1×2×0.8	7.6	65	15	LKI 1905 5200 0000	190552
JE-H(St)H FE180/E30-E90	Orange	2×2×0.8	8.5	88	25	LKI 1902 4500 0000	190245
JE-H(St)H FE180/E30-E90	Orange	2×2×0.8	8.5	88	25	LKI 8004 2200 0000	19024505*
JE-H(St)H FE180/E30-E90	Orange	4×2×0.8	12.1	147	45	LKI 1905 1700 0000	190517
JE-H(St)H FE180/E30-E90	Orange	8×2×0.8	17.6	280	85	LKI 1909 8700 0000	190987
JE-H(St)H FE180/E30-E90	Orange	12×2×0.8	19.8	365	126	LKI 1910 1900 0000	191019
JE-H(St)H FE180/E30-E90	Orange	16×2×0.8	23.3	480	166	LKI 8004 2300 0000	
JE-H(St)H FE180/E30-E90	Orange	20×2×0.8	24.5	590	206	LKI 1909 8800 0000	190988
JE-H(St)H FE180/E30-E90	Orange	32×2×0.8	35.9	1116	327	LKI 1912 7100 0000	191271
JE-H(St)H FE180/E30-E90	Orange	40×2×0.8	37.7	1230	407	LKI 8004 2400 0000	
JE-H(St)H FE180/E30-E90	Orange	52×2×0.8	40.7	1441	529	LKI 2114 9200 0000	211492
JE-H(St)H FE180/E30-E90	Orange	80×2×0.8	46.4	1850	810	LKI 8004 2500 0000	
JE-H(St)H FE180/E30-E90	Orange	100×2×0.8	52.6	2235	1030	LKI 8004 2600 0000	
JE-H(St)H FE180/E30-E90 BMK	Red	1×2×0.8	7.6	65	15	LKI 1906 7400 0000	190674
JE-H(St)H FE180/E30-E90 BMK	Red	2×2×0.8	8.5	88	25	LKI 1900 9300 0000	190093
JE-H(St)H FE180/E30-E90 BMK	Red	2×2×0.8	8.5	88	25	LKI 8004 3600 0000*	19009305*
JE-H(St)H FE180/E30-E90 BMK	Red	4×2×0.8	12.1	147	45	LKI 1900 9400 0000	190094
JE-H(St)H FE180/E30-E90 BMK	Red	8×2×0.8	17.6	280	85	LKI 1902 7000 0000	190270
JE-H(St)H FE180/E30-E90 BMK	Red	12×2×0.8	19.8	365	126	LKI 1906 7000 0000	190670
JE-H(St)H FE180/E30-E90 BMK	Red	16×2×0.8	23.3	480	166	LKI 8004 3700 0000	
JE-H(St)H FE180/E30-E90 BMK	Red	20×2×0.8	24.5	590	206	LKI 1906 6900 0000	190669
JE-H(St)H FE180/E30-E90 BMK	Red	32×2×0.8	35.9	1116	327	LKI 2114 8700 0000	211487
JE-H(St)H FE180/E30-E90 BMK	Red	40×2×0.8	37.7	1230	407	LKI 8004 3800 0000	
JE-H(St)H FE180/E30-E90 BMK	Red	52×2×0.8	40.7	1441	529	LKI 2112 4400 0000	211244
JE-H(St)H FE180/E30-E90 BMK	Red	80×2×0.8	46.4	1850	810		
JE-H(St)H FE180/E30-E90 BMK	Red	100×2×0.8	52.6	2235	1030	LKI 8004 4000 0000	

Core identification acc. to VDE 0815: ● bl/rd ● gr/ye ● gn/br ● wt/bl

Cables 2×2×... mm are twisted in Star Quad configuration.

Further designs upon request

* Standardized length 1×500 m

BETAflam® Fire alarm cables

DIN VDE 0815



REACH



Advantages

- Very high safety standards
- System circuit integrity acc. to DIN 4102 part 12
- DIN approved with LEONI BETAfixs® cable support system
- Halogen-free
- In compliance with REACH directive

BETAflam® JE-H(St)HRH FE180 / E30-E90

Applications

Shielded installation cable with steel braid armour for fixed installation in cable systems with improved fire performance and system circuit integrity acc. to DIN 4102 part 12, e.g. for:

- fire alarm systems and signalling etc.
- recommended in areas where people gather and for protection of valuables

Construction

■ Conductors	Bare annealed copper
■ Flame barrier	MICA tape
■ Insulation	BETAflam® copolymer
■ Banding	Polyester and glass fiber tape
■ Screen	Aluminium laminated polyester tape with bonding wire 0.8 mm Ø
■ Sheath	BETAflam® copolymer
■ Armouring	Galvanised steel wire braid
■ Outer sheath	BETAflam® copolymer
■ Core identification	acc. to VDE 0815 (bl/rd, gr/ye, gn/br, wt/bk)
■ Sheath colour	Red (fire alarm cable BMK)

Electrical characteristics

Operating voltage	225 V peak
Test voltage	0.5 / 2 kV, 50 Hz

Thermal characteristics

Operation temperature	-30 °C up to +70 °C
Laying temperature	-5 °C up to +50 °C

Bending radius

during laying	> 12 × outer Ø
fixed	> 8 × outer Ø

Laying conditions

- Fixed installation in dry and moist areas
- In or under plaster
- Not suitable in earth or concrete
- Outdoor laying only when protected from direct sunlight and other external impacts

Standards / Material properties

- Halogen-free: IEC 60754-1, EN 50267-2-1, VDE 0482-267-2-1
- No corrosive gases: IEC 60754-2, EN 50267-2-2, VDE 0482-267-2-2
- No toxic gases: NF X 70-100
- Low smoke density: IEC 61034-1 and -2, EN 61034-1 and -2, VDE 0482-1034-1 and -2
- Flame retardant: IEC 60332-1, EN 60332-1, VDE 0482-332-1
- No flame propagation: IEC 60332-3-10 and -3-24, EN 60332-3-10, -24, VDE 0482-332-3-24
- Circuit integrity FE180: IEC 60331-11 and -23, VDE 0472-814
- Circuit integrity with shock: EN 50200 PH90 (up to Ø 20 mm)
- System circuit integrity: DIN 4102-12, E30, E60, E90, depending on laying system

Cable type	Sheath colour	Construction	Outer Ø	Weight	Cu factor	Order no.	
						Germany	Switzerland
		n × 2 × mm	mm	kg / km	kg / km		
JE-H(St)HRH FE180 / E30-E90 BMK	● Red	2 × 2 × 0.8	11.7	185	25	LKI 1906 7100 0000	190671
JE-H(St)HRH FE180 / E30-E90 BMK	● Red	4 × 2 × 0.8	15.7	298	45	LKI 1917 3500 0000	191735
JE-H(St)HRH FE180 / E30-E90 BMK	● Red	8 × 2 × 0.8	21.6	509	85	LKI 2108 1100 0000	210811
JE-H(St)HRH FE180 / E30-E90 BMK	● Red	12 × 2 × 0.8	23.8	620	126	LKI 2108 1200 0000	210812
JE-H(St)HRH FE180 / E30-E90 BMK	● Red	16 × 2 × 0.8	27.7	730	166		
JE-H(St)HRH FE180 / E30-E90 BMK	● Red	20 × 2 × 0.8	28.9	942	206	LKI 2108 1300 0000	210813
JE-H(St)HRH FE180 / E30-E90 BMK	● Red	32 × 2 × 0.8	41.1	1702	326	LKI 2119 3900 0000	211939
JE-H(St)HRH FE180 / E30-E90 BMK	● Red	40 × 2 × 0.8	42.3	1880	407		225700
JE-H(St)HRH FE180 / E30-E90 BMK	● Red	52 × 2 × 0.8	45.2	2130	529	LKI 8004 5600 0000	

Core identification acc. to VDE 0815: ● bl/rd ● gr/ye ● gn/br ● wt/bl

Cables 2 × 2 × ... mm are twisted in Star Quad configuration.

Further designs upon request

BETAflam® Signal and fire alarm cables

DIN VDE 0815



REACH



Advantages

- Very high safety standards
- System circuit integrity acc. to DIN 4102 part 12
- DIN approved with LEONI BETAfixs® cable support system
- Halogen-free
- In compliance with REACH directive
- Smooth and compact

BETAflam® JE-HH FE180/E30 SIR

Applications

Unshielded installation cable for telecommunication and information processing units for fixed installation. In cable systems with improved fire performance and system circuit integrity acc. to DIN 4102 part 12, e.g. for:

- fire alarm systems and signalling etc.
- recommended in areas where people gather and for protection of valuables

Construction

- | | |
|-----------------------|---|
| ■ Conductors | Bare annealed copper |
| ■ Insulation | Silicone |
| ■ Flame barrier | Polyester tape |
| ■ Sheath | BETAflam® copolymer |
| ■ Core identification | acc. to VDE 0815 (bl/rd) |
| ■ Sheath colour | Orange or red
(fire alarm cable BMK) |

Electrical characteristics

Operating voltage	225 V peak
Test voltage	0.5 / 2 kV, 50 Hz

Thermal characteristics

Operation temperature	-30 °C up to +90 °C
Laying temperature	-5 °C up to +50 °C

Bending radius

during laying	> 12 × outer Ø
fixed	> 8 × outer Ø

Laying conditions

- Fixed installation in dry and moist areas
- In or under plaster
- Not suitable in earth or concrete
- Outdoor laying only when protected from direct sunlight and other external impacts

Standards / Material properties

- Halogen-free: IEC 60754-1, EN 50267-2-1, VDE 0482-267-2-1
- No corrosive gases: IEC 60754-2, EN 50267-2-2, VDE 0482-267-2-2
- Low smoke density: IEC 61034-1 and -2, EN 61034-1 and -2, VDE 0482-1034-1 and -2
- Flame retardant: IEC 60332-1, EN 60332-1, VDE 0482-332-1
- No flame propagation: IEC EN 60332-3-10, -3-23 and -3-24, VDE 0482-332-3-10, -332-3-23 und -332-3-24
- Circuit integrity FE180: IEC 60331-11 and -23, VDE 0472-814
- System circuit integrity: DIN 4102-12 E30-E60, depending on laying system

Cable type	Sheath colour	Construction	Outer Ø	Weight	Cu factor	Order no.	
			mm	kg / km	kg / km	Germany	Switzerland
JE-HH FE180/E30 SIR	● Orange	1×2×0.8 mm	5.7	40	9,6	∅	∅
JE-HH FE180/E30 SIR	● Orange	1×2×1.0 mm	6.7	55	14,4	∅	306599
JE-HH FE180/E30 SIR	● Orange	1×2×1.5 mm ²	7.7	79	29	∅	∅
JE-HH FE180/E30 SIR	● Red	1×2×0.8 mm	5.7	40	9,6	∅	308024
JE-HH FE180/E30 SIR	● Red	1×2×1.0 mm	6.7	55	14,4	∅	306600
JE-HH FE180/E30 SIR	● Red	1×2×1.5 mm ²	7.7	79	29	∅	∅
Further designs upon request						∅ on request	

BETAflam® Swiss standard cables

CH-N1EZ1-U/-R



REACH



Advantages

- Environment friendly and halogen-free, qualified to replace cables containing PVC
- In compliance with REACH directive
- Easy to strip
- Best electrical insulation properties, **also in wet environment**
- Optimal cost efficiency

BETAflam® FE0

Applications

Halogen-free installation cable for fixed and protected laying

- in tubes, trays, ducts
- cable laying systems
- concealed in buildings, tunnels and industrial facilities, ...
- not recommended for direct laying in earth or water

Construction

- | | |
|-----------------------|---------------------------------|
| ■ Conductors | Bare annealed copper, IEC 60228 |
| ■ Insulation | Polyethylene |
| ■ Core identification | acc. to HD 308 S2 |
| ■ Sheath | BETAflam® copolymer |
| ■ Sheath colour | Grey |

Electrical characteristics

- | | |
|---------------|--|
| Rated voltage | $U_0/U = 600 / 1000 \text{ V}$
(for fixed und protected laying) |
| Test voltage | 3500 V, 50 Hz |

Thermal characteristics

- | | |
|-----------------------|---------------------|
| Operation temperature | -25 °C up to +70 °C |
|-----------------------|---------------------|

Bending radius

cable design	single core	multiple core
during laying	> 12 × outer Ø	>10 × outer Ø
fixed	> 9 × outer Ø	>6 × outer Ø

Standards / Material properties

- Construction: SEV TP20B / 3C
- Halogen-free: IEC 60754-1, EN 50267-2-1, VDE 0482-267-2-1
- No corrosive gases: IEC 60754-2, EN 50267-2-2, VDE 0482-267-2-2
- Low smoke density: IEC 61034-2, EN 61034-2, VDE 0482-1034-2
- Flame retardant: IEC 60332-1, EN 60332-1-2, VDE 0482-332-1-2
- Approval: Electrosuisse SEV IK-1888, ESTI 12.0243

Cable type	Construction n × mm ²	Core function	Outer Ø mm	Weight kg / km	Cu factor kg / km	Order no.	
						Germany	Switzerland
FE0	1 G 6 RE	PE	5.6	76	58		212900
FE0	1 G 16 RM	PE	8.5	192	154		212909
FE0	2 × 1.5 RE	2L	6.4	55	29		212879
FE0	3 G 1.5 RE	LNPE	6.7	72	43		212880
FE0	3 G 2.5 RE	LNPE	7.9	106	72		212891
FE0	3 G 4 RE	LNPE	9.1	157	115		212898
FE0	3 G 6 RE	LNPE	10.5	220	173		212902
FE0	4 G 1.5 RE	3LPE	7.5	93	58		212882
FE0	4 G 2.5 RE	3LPE	8.8	138	96		212893
FE0	5 G 1.5 RE	3LNPE	8.2	116	72		212884
FE0	5 G 2.5 RE	3LNPE	9.8	175	120		212895
FE0	5 G 4 RE	3LNPE	11.1	253	192		212899
FE0	5 G 6 RE	3LNPE	12.9	361	288		212904
FE0	5 G 10 RM	3LNPE	18.1	652	480		212908
FE0	5 G 16 RM	3LNPE	20.9	963	768		212911
FE0	5 G 25 RM	3LNPE	26.0	1519	1200		212916
FE0	7 G 1.5 RE	NRPE	9.0	149	101		212885
FE0	10 G 1.5 RE	NRPE	11.1	212	144		214729
FE0	12 G 1.5 RE	NRPE	11.8	252	173		212887

G = with gn/ye conductor ●
 RE = round solid, class 1
 RM = round stranded, class 2

L = colour phase conductor br/bk/gr ● ● ●
 N = colour neutral conductor bl ●
 NR = colour phase conductors bk ● / numbered
 PE = colour earth conductor gn/ye ●

Further designs upon request

BETAflam® Swiss standard installation cables

CH-N07Z1Z1-F



REACH

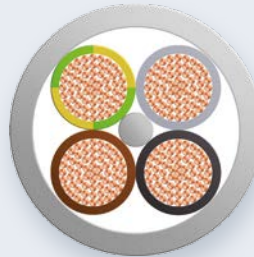
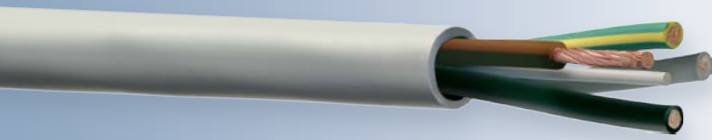

Advantages

- Cost savings due to simple installation and wiring
- Easy connection at limited space conditions
- Broad range of applications
- No flame propagation
- Good price-performance ratio
- Environmental-friendly materials; Halogen-free
- In compliance with REACH directive

BETAflam® INSTAflex

Applications

Installation cable with flexible conductor make-up, suitable for:

- constructions and civil engineering sectors
- industrial machinery
- heating and air-conditioning technology
- especially where halogen-free materials, no flame propagation, no pollutants and demanding laying conditions are required
- not recommended for direct laying in earth or water

Construction

- Conductors Bare fine copper strands acc. to IEC 60288, class 5
- Insulation BETAflam® copolymer
- Core identification ≤ 5 conductors coloured acc. to HD 308 S2
- Sheath ≥ 6 conductors black with white numbers
- Sheath colour BETAflam® copolymer, halogen-free Grey

Electrical characteristics

Rated voltage	U ₀ /U 450 / 750 V U ₀ /U 600 / 1000 V (for fixed installation)
Test voltage	3500 V

Thermal characteristics

for fixed installation	-40 °C up to +70 °C
occasionally moved	-25 °C up to +70 °C
Emergency operation	+90 °C shortterm

Bending radius

for fixed installation	> 4 × outer Ø
occasionally moved	> 8 × outer Ø
Bending test	medium duty (category 2) acc. to SEV TP 20B/3C

Standards / Material properties

- Halogen-free: IEC 60754-1, EN 50267-2-1
- No corrosive gases: IEC 60754-2, EN 50267-2-2
- Low smoke density: IEC 61034-2, EN 61034-2
- Flame retardant: IEC 60332-1, EN 60332-1
- No flame propagation: IEC 60332-3-24, EN 60332-3-10, -24
- Electrosuisse Certificate IK-2087
- Approval: Electrosuisse SEV IK-2087, ESTI 12.0695

Cable type	Construction n × mm ²	Core function	Core Ø	Outer Ø mm	Weight kg / km	Cu factor kg / km	Order no.	
							Germany	Switzerland
INSTAflex	3 G 1.5	LNPE	3.0	7.8	109	43		302518
INSTAflex	4 G 1.5	3LPE	3.0	8.6	139	58		302519
INSTAflex	5 G 1.5	3LNPE	3.0	9.6	173	72		302520
INSTAflex	7 G 1.5	NRPE	3.0	11.7	245	101		302521
INSTAflex	3 G 2.5	LNPE	3.7	10.5	160	72		302522
INSTAflex	4 G 2.5	3LPE	3.7	10.5	203	96		302523
INSTAflex	5 G 2.5	3LNPE	3.7	11.7	254	120		302524
INSTAflex	7 G 2.5	NRPE	3.7	14.5	299	168		302525
INSTAflex	4 G 4	3LPE	4.2	12.9	281	154		303225
INSTAflex	5 G 4	3LNPE	4.2	13.3	349	192		302526
INSTAflex	3 G 6	LNPE	4.8	13.6	297	173		303008
INSTAflex	4 G 6	3LPE	4.8	14.9	389	230		303226
INSTAflex	5 G 6	3LNPE	4.8	16.5	492	288		302527
INSTAflex	4 G 10	3LPE	6.3	19.1	619	384		303227
INSTAflex	5 G 10	3LNPE	6.3	21.3	777	480		302528
INSTAflex	1 × 16	L	7.8	10.3	225	154		302529
INSTAflex	1 G 16	PE	7.8	10.3	225	154		302530
INSTAflex	4 G 16	3LPE	7.8	23.2	936	614		303228
INSTAflex	5 G 16	3LNPE	7.8	25.1	1166	768		302531
INSTAflex	1 × 25	L	9.2	11.9	335	240		302532
INSTAflex	1 G 25	PE	9.2	11.9	335	240		302534
INSTAflex	4 G 25	3LPE	9.2	27.3	1465	960		303229
INSTAflex	5 G 25	3LNPE	9.2	30.0	1812	1200		302535
INSTAflex	1 × 35	L	10.4	13.3	440	336		302536
INSTAflex	1 G 35	PE	10.4	13.3	440	336		302537
INSTAflex	4 G 35	3LPE	10.4	30.3	1891	1344		303230
INSTAflex	5 G 35	3LNPE	10.4	33.7	2353	1680		302538

G = with gn/ye conductor ●

L = colour phase conductor ● ● ●

N = colour neutral conductor ●

NR = colour phase conductors bk ● / numbered

PE = colour earth conductor gn/ye ●

Further designs upon request

BETAflam® Swiss standard cables

CH-N1EZ1-U/-R



REACH



Advantages

- Environment friendly and halogen-free, qualified to replace PVC
- Halogen-free
- In compliance with REACH directive
- Easy to strip
- **Low temperature resistance up to -40°C**
Applicable in cold storing houses, deep-freeze rooms etc.
- Best electrical insulation properties, **also in wet environment**
- Optimal cost efficiency

BETAflam® FE5

Applications

Halogen-free installation cable with improved fire performance for fixed and protected laying:

- in tubes, trays, ducts, cable laying systems
- concealed in buildings, tunnels and industrial facilities, ...
- not recommended for direct laying in earth or water

Construction

- Conductors Bare annealed copper, IEC 60228
- Insulation Thermoplast, halogen-free
- Core identification acc. to HD 308 S2
- Sheath BETAflam® copolymer
- Sheath colour Orange

Electrical characteristics

Rated voltage	$U_0/U = 600 / 1000$ V (for fixed und protected laying)
Test voltage	3500 V, 50 Hz

Thermal characteristics

Operation temperature	-40 °C up to +70 °C
Emergency operation	+90 °C shortterm

Bending radius

cable design	single core	multiple core
during laying	> 12 × outer Ø	> 10 × outer Ø
fixed	> 9 × outer Ø	> 6 × outer Ø

Standards / Material properties

- Construction: SEV TP20B / 3C
- Halogen-free: IEC 60754-1, EN 50267-2-1, VDE 0482-267-2-1
- No corrosive gases: IEC 60754-2, EN 50267-2-2, VDE 0482-267-2-2
- No toxic gases: NF X 70-100
- Low smoke density: IEC 61034-2, EN 61034-2, VDE 0482-1034-2
- Flame retardant: IEC 60332-1, EN 60332-1-2, VDE 0482-332-1-2
- No flame propagation: IEC 60332-3-24, EN 60332-3-10, -24, VDE 0482-332-3-24
- Approval: Electrosuisse SEV CH-00-IK-1888, ESTI 12.0243

Cable type	Construction	Core function	Outer Ø	Weight	Cu factor
	n × mm ²		mm	kg / km	kg / km
FE5	1 G 4 RE	PE	6.0	78	38
FE5	1 G 6 RE	PE	6.6	93	58
FE5	1 G 10 RM	PE	8.3	150	96
FE5	1 G 16 RM	PE	9.4	210	154
FE5	1 G 25 RM	PE	10.9	333	240
FE5	1 G 35 RM	PE	12.1	420	336
FE5	1 G 50 RM	PE	13.4	579	480
FE5	1 G 70 RM	PE	15.6	810	672
FE5	1 G 95 RM	PE	17.9	1096	912
FE5	1 G 120 RM	PE	19.9	1368	1152
FE5	1 G 150 RM	PE	22.0	1660	1440

RE = round solid, class 1	L = colour phase conductor br/bk/gr ● ● ●
RM = round stranded, class 2	N = colour neutral conductor bl ●
PE = colour earth conductor gr/ye ●	NR = colour phase conductors bk ● / numbered
G = with conductor gr/ye ●	

Order no.	
Germany	Switzerland
	191099
	210808
	210810
	211287
	211187

Further designs upon request

Cable type	Construction	Core function	Outer Ø	Weight	Cu factor	Order no.	
	n × mm ²					mm	kg / km
FE5	1 G 185 RM	PE	24.2	2048	1776		
FE5	1 G 240 RM	PE	27.2	2541	2304		
FE5	1 G 300 RM	PE	31.1	3500	2880		
FE5	1 × 4 RE	L	6.0	78	38		
FE5	1 × 6 RE	L	6.6	93	58		
FE5	1 × 10 RM	L	8.3	150	96		
FE5	1 × 16 RM	L	9.4	210	154		
FE5	1 × 25 RM	L	10.9	333	240		
FE5	1 × 35 RM	L	12.1	420	336		
FE5	1 × 50 RM	L	13.4	579	480		210807
FE5	1 × 70 RM	L	15.6	810	672		211183
FE5	1 × 95 RM	L	17.9	1096	912		210809
FE5	1 × 120 RM	L	19.9	1368	1152		211286
FE5	1 × 150 RM	L	22.0	1660	1440		211186
FE5	1 × 185 RM	L	24.2	2048	1776		211288
FE5	1 × 240 RM	L	27.2	2541	2304		211188
FE5	1 × 300 RM	L	31.1	3500	2880		
FE5	2 × 1.5 RE	2L	7.3	79	29		191079
FE5	2 × 2.5 RE	2L	8.3	109	48		
FE5	3 G 1.5 RE	LNPE	7.6	91	43		191065
FE5	3 G 2.5 RE	LNPE	8.7	127	72		191087
FE5	3 G 4 RE	LNPE	9.9	182	115		
FE5	3 G 6 RE	LNPE	11.2	280	173		191092
FE5	4 G 1.5 RE	3LPE	8.3	112	58		191081
FE5	4 G 2.5 RE	3LPE	9.7	161	96		
FE5	4 G 4 RE	3LPE	10.8	314	154		
FE5	4 G 6 RE	3LPE	12.2	310	230		191093
FE5	4 G 10 RM	3LPE	14.5	480	384		
FE5	4 G 16 RM	3LPE	19.2	762	614		
FE5	4 G 25 RM	3LPE	23.2	1220	960		
FE5	4 G 35 RM	3LPE	26.7	1640	1344		
FE5	4 G 50 RM	3LPE	30.0	2494	1920		191104
FE5	4 G 70 RM	3LPE	36.3	3568	2688		
FE5	4 G 95 RM	3LPE	41.5	4914	3648		
FE5	4 G 120 RM	3LPE	46.7	6260	4608		
FE5	4 G 150 RM	3LPE	51.0	7496	5760		
FE5	4 G 185 RM	3LPE	57.3	9255	7104		
FE5	4 G 240 RM	3LPE	64.3	11961	9216		
FE5	5 G 1.5 RE	3LNPE	9.1	137	72		191083
FE5	5 G 2.5 RE	3LNPE	10.5	198	120		191091
FE5	5 G 4 RE	3LNPE	11.8	329	192		190735
FE5	5 G 6 RE	3LNPE	13.4	453	288		191094
FE5	5 G 10 RM	3LNPE	18.6	780	480		210731
FE5	5 G 16 RM	3LNPE	21.2	1130	768		191098
FE5	5 G 25 RM	3LNPE	26.0	1707	1200		191101
FE5	5 G 35 RM	3LNPE	29.7	2269	1680		191103
FE5	5 G 50 RM	3LNPE	33.6	3129	2400		191105
FE5	5 G 70 RM	3LNPE	40.3	4404	3360		211185
FE5	5 G 95 RM	3LNPE	47.1	5889	4560		191107
FE5	7 G 1.5 RE	NRPE	9.8	170	101		
FE5	7 G 2.5 RE	NRPE	11.3	296	168		211255

RE = round solid, class 1 L = colour phase conductor br/bk/gr ● ● ●
 RM = round stranded, class 2 N = colour neutral conductor bl ●
 PE = colour earth conductor gr/ye ● NR = colour phase conductors bk ● / numbered
 G = with conductor gr/ye ●

Further designs upon request

BETAflam® Swiss standard cables

CH-N1MZ1Z1-U/-R



REACH

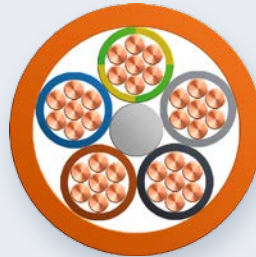

Advantages

- Very high safety standards
- System circuit integrity acc. to DIN 4102 part 12
- Halogen-free
- In compliance with REACH directive

BETAflam® FE180 / E30

Applications

Halogen-free safety cable for fixed and protected laying:

- in tubes, trays, ducts, cable laying systems
- concealed in buildings, tunnels and industrial facilities, ...
- not recommended for direct laying in earth or water

Construction

- | | |
|-----------------------|---------------------------------|
| ■ Conductors | Bare annealed copper, IEC 60228 |
| ■ Flame barrier | Mica tape |
| ■ Insulation | BETAflam® copolymer |
| ■ Core identification | acc. to HD 308 S2 |
| ■ Sheath | BETAflam® copolymer |
| ■ Sheath colour | Orange |

Electrical characteristics

Rated voltage	$U_0/U = 600 / 1000 \text{ V}$ (for fixed und protected laying)
Test voltage	3500 V, 50 Hz

Thermal characteristics

Operation temperature	-25 °C up to +90 °C
-----------------------	---------------------

Bending radius

cable design	single core	multiple core
during laying	$> 12 \times \text{outer } \emptyset$	$> 10 \times \text{outer } \emptyset$
fixed	$> 9 \times \text{outer } \emptyset$	$> 6 \times \text{outer } \emptyset$

Standards / Material properties

- Construction: SEV TP20B / 3C
- Halogen-free: IEC 60754-1, EN 50267-2-1, VDE 0482-267-2-1
- No corrosive gases: IEC 60754-2, EN 50267-2-2, VDE 0482-267-2-2
- No toxic gases: NF X 70-100
- Low smoke density: IEC 61034-2, EN 61034-2, VDE 0482-1034-2
- Flame retardant: IEC 60332-1, EN 60332-1-2, VDE 0482-332-1-2
- No flame propagation: IEC 60332-3-24, EN 60332-3-10, -24, VDE 0482-332-3-24
- Circuit integrity FE180: IEC 60331-21, VDE 0472-814
- Circuit integrity E30: DIN 4102 part 12
- Approval: Electrosuisse SEV CH-00-IK-0492.ZA1.E, ESTI 09.0561

Cable type	Construction	Core function	Outer Ø	Weight	Cu factor	Order no.	
						Germany	Switzerland
	n × mm ²		mm	kg / km	kg / km		
FE180/E30	1 G 4 RE	PE	5.5	101	38		
FE180/E30	1 G 6 RE	PE	6.2	121	58		
FE180/E30	1 G 10 RM	PE	8.0	160	96		
FE180/E30	1 G 16 RM	PE	9.2	254	154		
FE180/E30	1 G 25 RM	PE	10.8	311	240		
FE180/E30	1 G 35 RM	PE	13.0	439	336		
FE180/E30	1 G 50 RM	PE	14.1	569	480		223284
FE180/E30	1 G 70 RM	PE	16.4	795	672		223285
FE180/E30	1 G 95 RM	PE	19.1	1086	912		223286
FE180/E30	1 G 120 RM	PE	21.1	1353	1152		223287
FE180/E30	1 G 150 RM	PE	23.0	1637	1440		223288
FE180/E30	1 G 185 RM	PE	25.4	2020	1776		223289
FE180/E30	1 G 240 RM	PE	28.5	2606	2304		223290
FE180/E30	1 G 300 RM	PE	32.6	3464	2880		
FE180/E30	1 × 4 RE	L	5.5	101	38		
FE180/E30	1 × 6 RE	L	6.2	121	58		
FE180/E30	1 × 10 RM	L	8.0	160	96		
FE180/E30	1 × 16 RM	L	9.2	254	154		
FE180/E30	1 × 25 RM	L	10.8	311	240		
FE180/E30	1 × 35 RM	L	12.2	439	336		
FE180/E30	1 × 50 RM	L	14.1	569	480		222107
FE180/E30	1 × 70 RM	L	16.4	795	672		221756
FE180/E30	1 × 95 RM	L	19.1	1086	912		221758
FE180/E30	1 × 120 RM	L	21.1	1353	1152		221760
FE180/E30	1 × 150 RM	L	23.0	1637	1440		221762
FE180/E30	1 × 185 RM	L	25.4	2020	1776		221764
FE180/E30	1 × 240 RM	L	28.5	2606	2304		221766
FE180/E30	1 × 300 RM	L	32.6	3464	2880		221768
FE180/E30	2 × 1.5 RE	2L	8.4	96	29		221838
FE180/E30	2 × 2.5 RE	2L	9.5	122	48		221960
FE180/E30	2 × 4 RE	2L	9.6	157	77		
FE180/E30	2 × 6 RE	2L	10.9	208	115		
FE180/E30	2 × 10 RM	2L	14.6	380	192		
FE180/E30	2 × 16 RM	2L	17.1	572	307		
FE180/E30	2 × 25 RM	2L	20.5	700	480		
FE180/E30	3 G 1.5 RE	LNPE	8.8	106	43		221839
FE180/E30	3 G 2.5 RE	LNPE	9.9	144	72		221845
FE180/E30	3 G 4 RE	LNPE	10.1	188	115		302455
FE180/E30	4 G 1.5 RE	3LPE	9.6	133	58		221840
FE180/E30	4 G 2.5 RE	3LPE	10.9	183	96		221846
FE180/E30	4 G 4 RE	3LPE	11.2	288	154		304903
FE180/E30	4 G 6 RE	3LPE	12.8	335	230		
FE180/E30	4 G 10 RM	3LPE	17.4	572	384		304762
FE180/E30	4 G 16 RM	3LPE	20.0	835	614		221852
FE180/E30	4 G 25 RM	3LPE	24.2	1268	960		221854
FE180/E30	4 G 35 RM	3LPE	27.9	1757	1344		222774
FE180/E30	4 G 50 RM	3LPE	32.3	2403	1920		221857
FE180/E30	4 G 70 RM	3LPE	38.0	3449	2688		304767
FE180/E30	4 G 95 RM	3LPE	44.2	4592	3648		221860
FE180/E30	4 G 120 RM	3LPE	48.9	5660	4608		

RE = round solid, class 1 L = colour phase conductor br/bk/gr ● ● ●
 RM = round stranded, class 2 N = colour neutral conductor bl ●
 PE = colour earth conductor gn/ye ● NR = colour phase conductors bk ● / numbered
 G = with conductor gr/ye ●

Further designs upon request

Cable type	Construction n × mm ²	Core function	Outer Ø mm	Weight kg / km	Cu factor kg / km	Order no.	
						Germany	Switzerland
FE180/E30	4 G 150 RM	3LPE	54.0	6951	5760		
FE180/E30	4 G 185 RM	3LPE	59.2	8600	7104		
FE180/E30	4 G 240 RM	3LPE	67.4	11000	9216		
FE180/E30	5 G 1.5 RE	3LNPE	10.7	167	72		221841
FE180/E30	5 G 2.5 RE	3LNPE	12.2	232	120		221847
FE180/E30	5 G 4 RE	3LNPE	12.4	306	192		221848
FE180/E30	5 G 6 RE	3LNPE	14.2	419	288		221849
FE180/E30	5 G 10 RM	3LNPE	19.5	731	480		221851
FE180/E30	5 G 16 RM	3LNPE	22.6	1067	768		221853
FE180/E30	5 G 25 RM	3LNPE	26.8	1593	1200		221855
FE180/E30	5 G 35 RM	3LNPE	30.8	2215	1680		221856
FE180/E30	5 G 50 RM	3LNPE	36.3	3015	2400		221858
FE180/E30	5 G 70 RM	3LNPE	42.2	4219	3360		221859
FE180/E30	5 G 95 RM	3LNPE	49.0	5712	4560		221861
FE180/E30	7 G 1.5 RE	NRPE	11.5	209	101		221842
FE180/E30	7 G 2.5 RE	NRPE	13.2	296	168		221870
FE180/E30	7 G 4 RE	NRPE	13.6	423	269		
FE180/E30	12 G 1.5 RE	NRPE	15.4	357	173		221844
FE180/E30	12 G 2.5 RE	NRPE	17.7	506	288		300482
FE180/E30	21 G 1.5 RE	NRPE	19.4	608	302		215079
FE180/E30	27 G 1.5 RE	NRPE	22.2	769	389		222106

RE = round solid, class 1

RM = round stranded, class 2

PE = colour earth conductor gn/ye ●

G = with conductor gr/ye ●

L = colour phase conductor br/bk/gr ● ● ●

N = colour neutral conductor bl ●

NR = colour phase conductors bk ● / numbered

Further designs upon request

BETAflam® Swiss standard cables, armoured

CH-N1MZ1Z1Z4Z1-U/-R



REACH



Advantages

- Very high safety standards
- System circuit integrity acc. to DIN 4102 part 12
- Halogen-free
- In compliance with REACH directive
- For increased mechanical stress, e.g. as cable with rodent protection

BETAflam® FE180 / E30-CLE

Applications

Halogen-free safety cable. Light armoured execution for fixed and protected laying:

- in tubes, trays, ducts, cable laying systems
- concealed in buildings, tunnels and industrial facilities, ...
- circuit integrity and system circuit integrity depending on laying system
- not recommended for direct laying in earth or water

Construction

■ Conductors	Bare annealed copper, IEC 60228
■ Flame barrier	Mica tape
■ Insulation	BETAflam® copolymer
■ Core identification	acc. to HD 308 S2
■ Sheath/colour	BETAflam® copolymer, orange
■ Armouring	Steel tape (single core CU tape)
■ Protection sheath/colour	BETAflam® copolymer, black

Electrical characteristics

Rated voltage	$U_0/U = 600 / 1000V$ (for fixed und protected laying)
Test voltage	3500 V, 50 Hz

Thermal characteristics

Operation temperature – 25 °C up to + 90 °C

Bending radius

cable design	single core	multiple core
during laying	$> 20 \times \text{outer } \emptyset$	$> 18 \times \text{outer } \emptyset$
fixed	$> 12 \times \text{outer } \emptyset$	$> 10 \times \text{outer } \emptyset$

Standards / Material properties

- Construction: SEV TP20B / 3C
- Halogen-free: IEC 60754-1, EN 50267-2-1, VDE 0482-267-2-1
- No corrosive gases: IEC 60754-2, EN 50267-2-2, VDE 0482-267-2-2
- No toxic gases: NF X 70-100
- Low smoke density: IEC 61034-2, EN 61034-2, VDE 0482-1034-2
- Flame retardant: IEC 60332-1, EN 60332-1-2, VDE 0482-332-1-2
- No flame propagation: IEC 60332-3-24, EN 60332-3-10, -24, VDE 0482-332-3-24
- Circuit integrity FE180: IEC 60331-21, VDE 0472-814
- Circuit integrity E30: DIN 4102 part 12
- Approval: Electrosuisse SEV CH-00-IK-0492.ZA1.E, ESTI 09.0561

Cable type	Construction n × mm ²	Core function	Outer Ø mm	Weight kg / km	Cu factor kg / km	Order no.	
						Germany	Switzerland
FE180/E30-CLE	2 × 1.5 RE	2L	12.8	255	29		301445
FE180/E30-CLE	2 × 2.5 RE	2L	13.9	318	48		222517
FE180/E30-CLE	3 G 1.5 RE	LNPE	13.2	288	43		224050
FE180/E30-CLE	3 G 2.5 RE	LNPE	14.3	347	72		217088
FE180/E30-CLE	3 G 4 RE	LNPE	14.5	401	115		217400
FE180/E30-CLE	3 G 6 RE	LNPE	15.8	487	173		303556
FE180/E30-CLE	3 G 10 RM	LNPE	20.0	737	288		226080
FE180/E30-CLE	3 G 16 RM	LNPE	22.5	921	461		303557
FE180/E30-CLE	4 G 1.5 RE	3LPE	14.0	314	58		
FE180/E30-CLE	4 G 2.5 RE	3LPE	15.3	374	96		
FE180/E30-CLE	4 G 4 RE	3LPE	15.6	426	154		
FE180/E30-CLE	4 G 6 RE	3LPE	17.2	660	230		
FE180/E30-CLE	4 G 10 RM	3LPE	21.8	920	384		
FE180/E30-CLE	4 G 16 RM	3LPE	24.4	1228	614		224631
FE180/E30-CLE	4 G 25 RM	3LPE	28.6	1733	960		304765
FE180/E30-CLE	4 G 35 RM	3LPE	32.3	2311	1344		
FE180/E30-CLE	4 G 50 RM	3LPE	36.7	3028	1920		224024
FE180/E30-CLE	4 G 70 RM	3LPE	42.4	4054	2688		226082
FE180/E30-CLE	4 G 95 RM	3LPE	49.0	5485	3648		226081
FE180/E30-CLE	4 G 120 RM	3LPE	53.9	6300	4608		
FE180/E30-CLE	4 G 150 RM	3LPE	59.8	7700	5760		
FE180/E30-CLE	4 G 185 RM	3LPE	65.0	9800	7104		
FE180/E30-CLE	4 G 240 RM	3LPE	74.0	12000	9216		
FE180/E30-CLE	5 G 1.5 RE	3LNPE	15.1	372	72		301446
FE180/E30-CLE	5 G 2.5 RE	3LNPE	16.6	477	120		222518
FE180/E30-CLE	5 G 4 RE	3LNPE	16.8	555	192		223897
FE180/E30-CLE	5 G 6 RE	3LNPE	18.6	706	288		222176
FE180/E30-CLE	5 G 10 RM	3LNPE	23.9	1111	480		222775
FE180/E30-CLE	5 G 16 RM	3LNPE	27.0	1501	768		222512
FE180/E30-CLE	5 G 25 RM	3LNPE	31.2	2115	1200		220518
FE180/E30-CLE	5 G 35 RM	3LNPE	35.2	2813	1680		224807
FE180/E30-CLE	5 G 50 RM	3LNPE	40.7	3719	2400		217101
FE180/E30-CLE	5 G 70 RM	3LNPE	47.2	5157	3360		302965
FE180/E30-CLE	5 G 95 RM	3LNPE	54.0	6785	4560		224092
FE180/E30-CLE	7 G 1.5 RE	NRPE	15.9	521	101		303157
FE180/E30-CLE	7 G 2.5 RE	NRPE	17.6	560	168		217102
FE180/E30-CLE	7 G 4 RE	NRPE	18.0	679	269		300677
FE180/E30-CLE	12 G 1.5 RE	NRPE	19.8	644	173		
FE180/E30-CLE	12 G 2.5 RE	NRPE	22.1	977	288		
FE180/E30-CLE	21 G 1.5 RE	NRPE	23.8	963	302		

RE = round solid, class 1

RM = round stranded, class 2

PE = colour earth conductor gn/ye ●

G = with conductor gr/ye ●

L = colour phase conductor br/bk/gr ● ● ●

N = colour neutral conductor bl ●

NR = colour phase conductors bk ● / numbered

Further designs upon request

ROFLEX® Connection cables robust, flexible

CH-N05BQ-F / CH-N1BQ-F



REACH



Advantages

- Good resistance to abrasion
- Good cold flexibility up to -40°C
- Halogen-free
- In compliance with REACH directive
- Resistance to oil and fuel
- High resistance to weathering, ozone and UV rays
- Resistance to hydrolysis

ROFLEX®

Applications

For all flexible applications under extreme environmental conditions, because of a very good resistance to UV-rays, ozone and mineral oil.

Typical applications are:

- construction sites
- machine
- chemical and food industry
- agriculture and forestry
- municipal works
- traffic
- small electric tools
- lamps, etc.

Construction

- Conductors Bare fine copper strands acc. to VDE 0295 / IEC 60228, class 5
- Insulation Cross-linked ethylene-propylene-rubber (EPR)
- Colour of conductors ≤ 5 : cores acc. to HD 308 S2
 ≥ 6 : cores black with numbers in bright colour and green-yellow
- Outer sheath Polyether-polyurethane (PUR)
- Sheath colour Orange (further colours on request)

Electrical characteristics

Rated voltage	$U_0/U \leq 1 \text{ mm}^2$ 300 / 500 V, $\geq 1.5 \text{ mm}^2$ 600 / 1000 V
Test voltage	3500 V

Thermal characteristics

Max. conductor temperature	
fixed installation	+ 90 °C
occasionally moved	+ 80 °C
short term fixed installation	+ 120 °C

Min. ambient temperature

fixed installation	- 55 °C
occasionally moved	- 40 °C

Bending radius

fixed installation	$> 4 \times \text{outer } \emptyset$
occasionally moved	$> 8 \times \text{outer } \emptyset$

Standards / Material properties

- Halogen-free: IEC 60754-1, EN 50267-2-1
- No corrosive gases: IEC 60754-2, EN 50267-2-2
- Resistance to oil: EN 60811-2-1 (24 hrs / 100 °C)
- Good resistance to abrasion

Specialities

- Assembled and shielded cables upon request
- Types with customer imprints:
Minimum order quantities $300 \text{ m} \leq 10 \text{ mm}^2$, $100 \text{ m} \geq 16 \text{ mm}^2$
- on request acc. to VDE H05BQ-F / H07BQ-F

Cable type	Construction n × mm ²	Core function	Core Ø mm	Outer Ø mm	Weight kg/km	Fire load kWh/m	Cu factor kg/km	Order no.	
								Germany	Switzerland
ROFLEX	2 × 1	LN	2.6	7.0	55	0.25	19.2		188903
ROFLEX	3 G 1	LNPE	2.6	7.4	69	0.26	28.8		188918
ROFLEX	4 G 1	2LNPE	2.6	8.1	85	0.30	38.0		188917
ROFLEX	4 G 1	3LPE	2.6	8.1	85	0.30	38.0		300278
ROFLEX	5 G 1	3LNPE	2.6	9.0	105	0.36	48.0		188916
ROFLEX	7 G 1	NRPE	2.6	10.9	146	0.46	67.0		211769
ROFLEX	2 × 1.5	LN	2.9	7.6	70	0.29	28.8		188761
ROFLEX	3 G 1.5	LNPE	2.9	8.2	85	0.32	43.2		188762
ROFLEX	4 G 1.5	2LNPE	2.9	9.0	107	0.36	58.0		188763
ROFLEX	4 G 1.5	3LPE	2.9	9.0	107	0.36	58.0		300279
ROFLEX	5 G 1.5	3LNPE	2.9	10.0	130	0.45	72.0		188764
ROFLEX	7 G 1.5	NRPE	2.9	11.9	190	0.60	101.0		188765
ROFLEX	8 G 1.5	NRPE	2.9	13.0	212	0.72	115.0		300010
ROFLEX	10 G 1.5	NRPE	2.9	14.4	310	0.73	144.0		
ROFLEX	12 G 1.5	NRPE	2.9	14.4	280	0.76	173.0		191603
ROFLEX	16 G 1.5	NRPE	2.9	16.2	450	0.98	230.0		188914
ROFLEX	2 × 2.5	LN	3.5	8.9	98	0.39	48.0		303396
ROFLEX	3 G 2.5	LNPE	3.5	9.4	120	0.41	72.0		188766
ROFLEX	4 G 2.5	2LNPE	3.5	10.6	158	0.49	96.0		188767
ROFLEX	4 G 2.5	3LPE	3.5	10.6	158	0.49	96.0		222884
ROFLEX	5 G 2.5	3LNPE	3.5	11.7	200	0.59	120.0		188768
ROFLEX	7 G 2.5	NRPE	3.5	14.4	280	0.85	168.0		188769
ROFLEX	2 × 4	LN	4.3	12.1	158	0.54	76.8		303398
ROFLEX	3 G 4	LNPE	4.3	13.0	208	0.65	115.2		300280
ROFLEX	4 G 4	3LPE	4.3	14.4	277	0.77	153.6		300954
ROFLEX	5 G 4	3LNPE	4.3	15.8	320	0.93	192.0		188771
ROFLEX	7 G 4	NRPE	4.3	18.9	440	1.29	268.8		
ROFLEX	2 × 6	LN	5.0	13.5	234	0.66	115.2		
ROFLEX	3 G 6	LNPE	5.0	14.5	300	0.83	172.8		188773
ROFLEX	4 G 6	3LPE	5.0	16.1	367	0.97	230.4		222885
ROFLEX	5 G 6	3LNPE	5.0	17.8	488	1.18	288.0		188775
ROFLEX	7 G 6	NRPE	5.0	21.1	643	1.68	403.2		303368
ROFLEX	4 G 10	3LPE	6.2	19.6	570	2.25	384.0		222891
ROFLEX	5 G 10	3LNPE	6.2	21.6	694	2.64	480.0		188912
ROFLEX	3 G 16	LNPE	7.8	21.9	661	1.182	461.0		218978
ROFLEX	4 G 16	3LPE	7.8	23.6	833	3.00	614.4		222892
ROFLEX	5 G 16	3LNPE	7.8	26.2	1016	3.54	768.9		188777
ROFLEX	3 G 25	LNPE	9.2	24.9	1017	3.50	720.0		305882
ROFLEX	4 G 25	3LPE	9.2	27.3	1311	4.46	960.0		222893
ROFLEX	5 G 25	3LNPE	9.2	30.1	1525	4.63	1200.0		188778
ROFLEX	4 G 35	3LPE	10.5	30.8	1634	4.62	1344.0		305811
ROFLEX	5 G 35	3LNPE	10.5	34.1	2050	5.53	1680.0		188779
ROFLEX	1 × 50	L	12.4	16.2	575	1.53	480.0		191705
ROFLEX	1 G 50	PE	12.4	16.2	575	1.53	480.0		191707

Further designs upon request

G = with conductor gr/ye ●

Cable type	Construction n × mm ²	Core function	Core Ø mm	Outer Ø mm	Weight kg / km	Fire load kWh / m	Cu factor kg / km	Order no.	
								Germany	Switzerland
ROFLEX	4 G 50	3LPE	12.4	36.3	2355	6.82	1920.0		222894
ROFLEX	5 G 50	3LNPE	12.4	40.5	2990	8.57	2400.0		188780
ROFLEX	4 G 70	3LPE	14.2	40.7	3195	8.43	2688.0		305828
ROFLEX	5 G 70	3LNPE	14.2	46.0	4020	10.57	3360.0		188781
ROFLEX	1 × 95	L	16.4	20.4	984	2.20	912.0		221534
ROFLEX	1 G 95	PE	16.4	20.4	984	2.20	912.0		223542
ROFLEX	5 G 95	3LNPE	16.4	52.2	5356	12.56	4560.0		188782
ROFLEX	1 × 120	L	18.4	22.6	1238	2.55	1152.0		221535
ROFLEX	1 G 120	PE	18.4	22.6	1238	2.55	1152.0		223543
ROFLEX	1 × 150	L	20.8	25.2	1531	3.15	1440.0		221536
ROFLEX	1 G 150	PE	20.8	25.2	1531	3.15	1440.0		223544
ROFLEX	1 × 185	L	22.9	27.5	1845	3.51	1776.0		221537
ROFLEX	1 G 185	PE	22.9	27.5	1845	3.51	1776.0		223545
ROFLEX	1 × 240	L	25.8	30.6	2389	4.01	2304.0		221538
ROFLEX	1 G 240	PE	25.8	30.6	2389	4.01	2304.0		223546

Further designs upon request

G = with conductor gr/ye ●



BETAdrive® Connection cables for motors

shielded, flame retardant

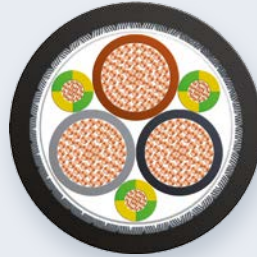

Advantages

- EMC optimised braided shielding
- Multicore and flexible
- Symmetrical conductor layout
- Very good oil and chemical resistance
- High fire performance, halogen-free
- UV and weather resistant

BETAdrive® C-flex

Applications

This cable is designed and electrically optimised for power supply between frequency converters and low-voltage electric motors:

- suitable for fixed and flexible applications for average mechanical stress used in dry, humid and temporarily wet rooms
- UV and weather resistant

Construction

- | | |
|---------------------|---|
| ■ Conductors | Bare fine copper strands acc. to VDE 0295 / IEC 60228, class 5 |
| ■ Insulation | Polyolefine copolymer, core identification acc. to HD 308 S2 |
| ■ Earth conductor | Bare fine copper strands, insulation green-yellow, 3 conductors |
| ■ Tape | Plastic tape halogen-free |
| ■ Shielding | Aluminum laminated foil plus tinned fine wire copper braid |
| ■ Dual layer sheath | Inner layer → Polyolefine copolymer
Outer layer → TPE |
| ■ Sheath colour | Black |

Electrical characteristics

Rated voltage	U ₀ /U 600 V / 1000 V	
Test voltage	Conductor / conductor	3500 V
	Conductor / shielding	2500 V

Thermal characteristics

Continuous duty	+ 90 °C
Short-circuit	+160 °C (max. 5 s)

Bending radius

	cable Ø < 30 mm	cable Ø > 30 mm
during laying	> 12 × outer Ø	> 15 × outer Ø
fixed	> 8 × outer Ø	> 10 × outer Ø

Pulling on conductors

Max. 40 N/mm² ((3 + 3) × cross section × 40 N/mm²)



Standards / Material properties

- Halogen-free: IEC 60754-1, EN 50267-2-1
- No corrosive gases: IEC 60754-2, EN 50267-2-2
- No toxic gases: NF X 70-100
- Resistance to oil: EN 60811-2-1 (24 h / 70 °C), SEV TP 20 B/3 C (72 h / 70 °C)
- Chemical resistance: See table page 54
- Low smoke density: IEC 61034, EN 61034
- Flame retardant: IEC 60332-1, EN 60332-1
- Low fire load: DIN 51900

Cable type	Construction	Core function	Outer Ø	Weight	Shield cross section	Fire load	Cu factor	Order no.	
								Germany	Switzerland
	n × mm ²		mm	kg / km	kg / km	kWh / m	kg / km		
BETAdrive C-flex	3 × 1.5 + 3 × 0.25	3L+3PE	9.7	151	2.8	0.33	90		302799
BETAdrive C-flex	3 × 2.5 + 3 × 0.5	3L+3PE	11.4	216	4.2	0.44	126		302800
BETAdrive C-flex	3 × 4 + 3 × 0.75	3L+3PE	13.0	294	4.2	0.54	182		302801
BETAdrive C-flex	3 × 6 + 3 × 1	3L+3PE	13.8	372	4.2	0.60	250		302802
BETAdrive C-flex	3 × 10 + 3 × 2.5	3L+3PE	19.1	661	8	1.05	452		302270
BETAdrive C-flex	3 × 16 + 3 × 2.5	3L+3PE	20.8	862	10	1.23	640		301017
BETAdrive C-flex	3 × 25 + 3 × 4	3L+3PE	24.4	1253	10	1.63	951		301018
BETAdrive C-flex	3 × 35 + 3 × 6	3L+3PE	27.6	1650	10	2.01	1301		302271
BETAdrive C-flex	3 × 50 + 3 × 10	3L+3PE	32.7	2412	19	2.78	1981		301019
BETAdrive C-flex	3 × 70 + 3 × 16	3L+3PE	36.6	3291	19	3.65	2721		302272
BETAdrive C-flex	3 × 95 + 3 × 16	3L+3PE	41.4	4013	19	4.18	3459		302273
BETAdrive C-flex	3 × 120 + 3 × 25	3L+3PE	46.3	5416	19	5.91	4491		301020
BETAdrive C-flex	3 × 150 + 3 × 25	3L+3PE	51.5	6391	19	6.80	5383		301021
BETAdrive C-flex	3 × 185 + 3 × 35	3L+3PE	56.7	7653	19	7.61	6705		302274
BETAdrive C-flex	3 × 240 + 3 × 50	3L+3PE	62.8	9984	19	9.17	8766		302275

Further designs upon request

Current rating

Type	Construction	Laying in tube in earth ⁴ 			Laying on traces 		
		Current load ¹ / Industrial load ²		Emergency ³	Current load ¹		Emergency ³
		60 °C / A	90 °C / A	130 °C / A	60 °C / A	90 °C / A	130 °C / A
BETAdrive C-flex	3 × 1.5 + 3 × 0.25	17 / 19	21 / 25	25	16	24	30
BETAdrive C-flex	3 × 2.5 + 3 × 0.5	22 / 26	28 / 33	33	22	32	41
BETAdrive C-flex	3 × 4 + 3 × 0.75	29 / 34	37 / 43	43	30	43	55
BETAdrive C-flex	3 × 6 + 3 × 1	36 / 43	46 / 54	54	37	54	69
BETAdrive C-flex	3 × 10 + 3 × 2.5	52 / 61	65 / 77	77	55	79	101
BETAdrive C-flex	3 × 16 + 3 × 2.5	67 / 79	84 / 99	100	72	103	132
BETAdrive C-flex	3 × 25 + 3 × 4	87 / 103	110 / 129	130	95	137	174
BETAdrive C-flex	3 × 35 + 3 × 6	105 / 124	132 / 156	157	116	166	212
BETAdrive C-flex	3 × 50 + 3 × 10	132 / 156	167 / 196	197	149	214	272
BETAdrive C-flex	3 × 70 + 3 × 16	164 / 193	207 / 244	245	189	270	344
BETAdrive C-flex	3 × 95 + 3 × 16	190 / 224	240 / 282	283	219	314	399
BETAdrive C-flex	3 × 120 + 3 × 25	222 / 261	280 / 329	331	261	373	474
BETAdrive C-flex	3 × 150 + 3 × 25	252 / 296	318 / 374	376	299	428	545
BETAdrive C-flex	3 × 185 + 3 × 35	281 / 331	355 / 418	421	337	482	613
BETAdrive C-flex	3 × 240 + 3 × 50	330 / 388	417 / 491	495	403	576	733

¹ Load factor 24 h, 100 % nominal current (principal application in power plants)

² Load factor 10 h, 100% and 14 h, 60% nominal current (standard application)

³ Maximum 8 h/day and 100 h/year

⁴ Minimal inner diameter of the tube: minimum 1.5 × diameter of the cable

BETAdrive® Connection cables for motors

shielded, with circuit integrity

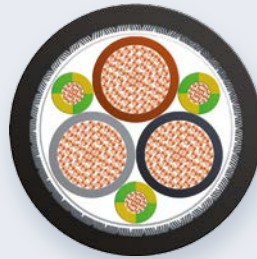

Advantages

- EMC optimised braided shielding
- Multicore and flexible
- Symmetrical conductor layout
- Very good oil and chemical resistance
- High fire performance, halogen-free
- UV and weather resistant
- Circuit integrity in case of fire

BETAdrive® FE180 C-flex

Applications

This cable is designed and electrically optimised for power supply between frequency converters and low-voltage electric motors:

- suitable for fixed and flexible applications for average mechanical stress used in dry, humid and temporarily wet rooms
- UV and weather resistant
- Circuit integrity in case of fire

Construction

- Conductors Bare fine copper strands acc. to VDE 0295 / IEC 60228, class 5
- Insulation Polyolefine copolymer, core identification acc. to HD 308 S2
- Earth conductor Bare fine copper strands, Insulation green-yellow, 3 conductors
- Tape Plastic tape halogen-free
- Shielding Aluminum laminated foil plus tinned fine wire copper braid
- Dual layer sheath Inner layer → Polyolefine copolymer
Outer layer → TPE
- Sheath colour Black

Electrical characteristics

Rated voltage	U ₀ /U 600 V / 1000 V	
	Conductor / conductor	3500 V
Test voltage	Conductor / shielding	2500 V

Thermal characteristics

Continuous duty	+ 90 °C
Short-circuit	+160 °C (max. 5 s)

Bending radius

	cable Ø < 30 mm	cable Ø > 30 mm
during laying	> 12 × outer Ø	> 15 × outer Ø
fixed	> 8 × outer Ø	> 10 × outer Ø

Pulling on conductors

Max. 40 N/mm² ((3 + 3) × cross section × 40 N/mm²)

Standards / Material properties

- Halogen-free: IEC 60754-1, EN 50267-2-1
- No corrosive gases: IEC 60754-2, EN 50267-2-2
- No toxic gases: NF X 70-100
- Resistance to oil: EN 60811-2-1 (24 h / 70 °C), SEV TP 20 B/3 C (72 h / 70 °C)
- Chemical resistance: See table page 54
- Low smoke density: IEC 61034, EN 61034
- Flame retardant: IEC 60332-1, EN 60332-1
- No flame propagation: IEC 60332-3, EN 60332-3
- Low fire load: DIN 51900
- Circuit integrity FE180: IEC 60331-11 and -21, VDE 0472-814

Cable type	Construction	Core function	Outer Ø	Weight	Shield cross section	Fire load	Cu factor	Order no.	
								Germany	Switzerland
	n × 2 × mm		mm	kg / km	kg / km	kWh / m	kg / km		
BETAdrive FE180 C-flex	3 × 1.5 + 3 × 0.25	3L+3PE	12.7	232	2.8	0.33	102		304973
BETAdrive FE180 C-flex	3 × 2.5 + 3 × 0.5	3L+3PE	13.7	277	4.2	0.44	133		304974
BETAdrive FE180 C-flex	3 × 4 + 3 × 0.75	3L+3PE	14.5	Ø	4.2	0.54	182		Ø
BETAdrive FE180 C-flex	3 × 6 + 3 × 1	3L+3PE	15.2	427	4.2	0.66	250		Ø
BETAdrive FE180 C-flex	3 × 10 + 3 × 2.5	3L+3PE	20.0	Ø	8	1.08	452		Ø
BETAdrive FE180 C-flex	3 × 16 + 3 × 2.5	3L+3PE	22.7	967	10	1.36	641		Ø
BETAdrive FE180 C-flex	3 × 25 + 3 × 4	3L+3PE	26.2	1371	10	1.76	964		306758
BETAdrive FE180 C-flex	3 × 35 + 3 × 6	3L+3PE	29.9	1885	19	2.25	1381		307266
BETAdrive FE180 C-flex	3 × 50 + 3 × 10	3L+3PE	26.3	2714	19	2.86	1941		Ø
BETAdrive FE180 C-flex	3 × 70 + 3 × 16	3L+3PE	43.6	3757	19	4.03	2735		Ø
BETAdrive FE180 C-flex	3 × 95 + 3 × 16	3L+3PE	44.9	4388	19	5.00	3480		305181
BETAdrive FE180 C-flex	3 × 120 + 3 × 25	3L+3PE	50.4	Ø	19	5.42	4492		Ø
BETAdrive FE180 C-flex	3 × 150 + 3 × 25	3L+3PE	54.0	6698	19	6.94	5385		304103
BETAdrive FE180 C-flex	3 × 185 + 3 × 35	3L+3PE	60.8	8244	19	8.23	6711		Ø
BETAdrive FE180 C-flex	3 × 240 + 3 × 50	3L+3PE	66.0	Ø	19	9.53	8779		Ø

Ø on request

Chemical resistance BETAdrive® cable

Outer sheath

Tested in our laboratory

- ≤ 3 % compatible
- ≤ 15 % casual contact
- ≤ 25 % casual contact, limited compatible



Medium	Fluids	Time	Temperature	Ultimate elongation	Strength change
		Tage	°C	%	%
Automotive fluids	Battery acid 37 %	7	23	-2	-2
	Hydraulic Brake Fluid DOT3	3	50	± 0	-2
		7	23	+1	-4
	Antifreeze 50 %	3	50	-1	-2
		7	23	± 0	-1
Automatic Transmissions Fluid		3	50	-4	-11
Industrial fluids	Skydrol LD 4	3	50	-5	± 0
		7	23	-10	-3
Petroleum, oils, fuels	IRM 902	1	70	+23	-14
		3	50	-5	-11
IRM 903		1	70	-18	-25
Organic solvents	Alcohol 96 %	7	23	+1	+1
	Methylethylketone	7	23	+1	-4
	Xylene	7	23	+11	-11
Acids, alkalis	Sodium hydroxide 10%	7	23	+1	-5
	Sulfuric acid 35 %	7	23	-2	-2
Aqueous solutions	Sodium chloride 15 %	7	23	+12	-3
	Water	7	23	+5	+1

Please be advised that those values are without obligation. For final evaluation a test under real conditions would be necessary. Further tests could be also made in our laboratory.



BETApower® Medium voltage cables

with circuit integrity



Advantages

- Insulation integrity maintained for over 180 minutes
- Flame retardant, no fire propagation
- Longitudinally and transversely watertight
- Long service life
- Halogen-free / Ecology
- Reduced shielding losses
- Robust abrasion resistant sheath
- Compact / light / modular

BETApower® Fireprotect 12 / 20 kV

Applications

Medium voltage wiring with insulation integrity in the event of fire.

Use in safety-relevant construction designs in:

- public buildings
- tunnels
- underground train systems
- civil engineering works

Construction

- | | |
|---|---|
| ■ Conductor | Copper multi-compact conductor according to VDE 0295 / IEC 60228, class 2 |
| ■ Internal semi-conductor layer / XLPE dielectric / External semi-conductor layer | Extruded in a single process, welded boundary layers |
| ■ Semi-conductor swelling tape | Padded strip, longitudinally watertight |
| ■ Aluminium shielding, tubular | Aluminium tape, overlapped and glued, transversely watertight |
| ■ Sheath | Polyolefin-Copolymer, black |
| ■ Thermal barrier | Special intumescent intermediate layer |
| ■ Outer sheath | Polyolefin-Copolymer, double layer, black with red longitudinal stripes |

Electrical characteristics

Rated voltage	U/U ₀ 20/12 kV (10/6 kV upon request) A voltage (U _m) of 20 % more than the normal voltage is admissible at continuous operation.
Test voltage	4 × U ₀ at 50 Hz during 20 min
Partial discharge test	Test voltage 4 × U ₀ level < 2 pC during 20 min

Thermal characteristics

Continuous operation	+ 90 °C
Emergency operation	+130 °C (< 8 hrs/day; <100 hrs/annum)
Short-circuit	+250 °C (max. 5 s)

Bending radius

during laying	> 15 × outer Ø
fixed	> 11 × outer Ø

Pulling on conductors

Max. 60 N/mm² (1 × conductor cross section × 60 N/mm²)

Standards / Material properties

- Construction: CENELEC HD 620 S1
- Halogen-free: IEC 60754-1, EN 50267-2-1
- No corrosive gases: EN 50267-2-3
- No toxic gases: NES 02-713
- Flame retardant: IEC 60332-1, EN 60332-1
- No flame propagation: IEC 60332-3-24, EN 60332-3-24
- Circuit integrity based on: IEC 60331-11 and 21; BS 6387 C

Specialities

- Open tray laying as well as in tubes
- Special design with a copper tube screen upon request
- Compact construction
- **Recommendation:** For an optimized shield connection use end and connecting elements provided by LEONI
- Electrosuisse certified, SEV

Construction	Conductor		Weight	Tensile strength		Fire load	AC resistance	Capacity	Inductance		Order no.	
	insulation-Ø	Outer Ø		max. kN	Fire load				Ω/km, 60 °C	μF / km		
$n \times mm^2$	mm	mm	kg / km	max. kN	kWh / m	Ω/km, 60 °C	μF / km	mH / km	mH / km	Germany	Switzerland	
1 × 50/27 Al	19.80	39.50	1997	3.0	7.42	0.448	0.182	0.446	0.631		306076	
1 × 95/32 Al	23.40	43.10	2637	5.7	8.77	0.224	0.230	0.403	0.588		306077	
1 × 150/34 Al	26.10	45.80	3254	9.0	9.72	0.144	0.265	0.379	0.564		306078	
1 × 185/38 Al	27.90	47.60	3693	11.1	10.41	0.116	0.288	0.367	0.551		306079	
1 × 240/39 Al	30.20	49.90	4335	14.4	11.21	0.089	0.318	0.353	0.538			
1 × 300/41 Al	available upon request											
1 × 400/45 Al	available upon request											

Current rating

Construction	Laying in tube in earth ⁴					
	Current load ¹ / Industrial load ² 60 °C		90 °C		Emergency service ³ 130 °C	
$n \times mm^2$	A	A	A	A	A	A
1 × 50/27 Al	154 / 181	180 / 212	194 / 229	227 / 267	230	268
1 × 95/32 Al	225 / 265	263 / 310	283 / 333	332 / 391	335	393
1 × 150/34 Al	291 / 342	335 / 394	366 / 431	422 / 497	433	500
1 × 185/38 Al	328 / 386	379 / 446	414 / 487	478 / 562	490	565
1 × 240/39 Al	380 / 447	439 / 517	480 / 564	554 / 652	568	656

Construction	Laid in air					
	Current load ¹ 60 °C		90 °C		Emergency service ³ 130 °C	
$n \times mm^2$	A	A	A	A	A	A
1 × 50/27 Al	185	207	263	292	332	367
1 × 95/32 Al	278	313	396	442	502	556
1 × 150/34 Al	360	406	514	575	652	725
1 × 185/38 Al	412	466	589	660	747	832
1 × 240/39 Al	484	549	692	779	880	983

¹ Load factor 24 h, 100 % nominal current (main application: power plants)
² Load factor 10 h, 100 % and 14 h, 60 % nominal current (standard application)
³ Maximum 8 h a day and maximum 100 h a year
⁴ Inner diameter of tube at least 3 x overall diameter
⁵ Inner diameter of tube at least 1.5 x cable diameter

Basis of calculation: Depth of laying 1 m, ground temperature 20 °C, air temperature 30 °C, shields connected to earth on both sides, specific thermal resistance 1K m/W, protected against direct sunlight, each cable system laid separately.

Signal and fire alarm cables

DIN VDE 0815



REACH

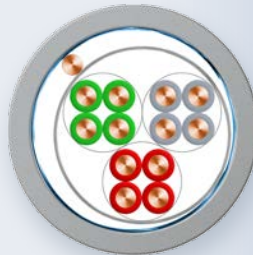

Advantages

- High safety standards
- Halogen-free
- In compliance with REACH directive

J-H(St)H

Applications

Halogen-free installation cable with improved fire performance and system circuit integrity:

- for telephone-, measure and signal purposes
- fire alarm cable in buildings where people gather and for protection of valuables

Construction

■ Conductors	Bare annealed copper
■ Insulation	BETAflam® halogen-free Copolymer
■ Core identification	acc. to VDE 0815
■ Stranding	Bundle stranding
■ Screen	Aluminium laminated polyester tape with bonding wire
■ Sheath	BETAflam® halogen-free Copolymer
■ Sheath colour	Grey or red (fire alarm cable)

Electrical characteristics

Operating voltage	300 V peak
Test voltage	800 V, 50 Hz

Thermal characteristics

Operation temperature	-30 °C up to +70 °C
Laying temperature	-5 °C up to +50 °C

Bending radius

during laying	> 12 × outer Ø
fixed	> 8 × outer Ø

Laying conditions

- Fixed installation in dry and moist areas, in or under plaster
- Outdoor laying only when protected from direct sunlight and other external impacts
- Not suitable in earth or concrete

Standards / Material properties

- Halogen-free: IEC 60754-1, EN 50267-2-1, VDE 0482-267-2-1
- No corrosive gases: IEC 60754-2, EN 50267-2-2, VDE 0482-267-2-2
- Low smoke density: IEC 61034-1 and -2, EN 61034-1 and -2, VDE 0482-1034-1 and -2
- Flame retardant: IEC 60332-1, EN 60332-1, VDE 0482-332-1
- No flame propagation: IEC 60332-3-10 and -3-24, EN 60332-3-10, -24, VDE 0482-332-3-24

Cable type	Construction	Outer Ø	Weight	Cu factor	Order no.	
					Germany	Switzerland
J-H(St)H grey 0.6	n × 2 × mm	mm	kg / km	kg / km		
J-H(St)H grey 0.6	2 × 2 × 0.6	5.4	48	14	LKI 8008 8800 0000	
J-H(St)H grey 0.6	4 × 2 × 0.6	7.4	80	25	LKI 8008 8900 0000	
J-H(St)H grey 0.6	6 × 2 × 0.6	7.7	105	37	LKI 8008 9000 0000	
J-H(St)H grey 0.6	10 × 2 × 0.6	9.1	140	59	LKI 8008 9100 0000	
J-H(St)H grey 0.6	20 × 2 × 0.6	13.5	245	116	LKI 8008 9200 0000	
J-H(St)H grey 0.6	30 × 2 × 0.6	15.1	330	172	LKI 8008 9300 0000	
J-H(St)H grey 0.6	50 × 2 × 0.6	18.6	570	286	LKI 8008 9500 0000	
J-H(St)H grey 0.8	2 × 2 × 0.8	6.8	66	25	LKI 8009 1700 0000	
J-H(St)H grey 0.8	4 × 2 × 0.8	9.1	105	45	LKI 8009 1800 0000	
J-H(St)H grey 0.8	6 × 2 × 0.8	9.6	135	65	LKI 80091 900 0000	
J-H(St)H grey 0.8	10 × 2 × 0.8	11.2	205	106	LKI 8009 2000 0000	
J-H(St)H grey 0.8	20 × 2 × 0.8	16.5	370	206	LKI 8009 2100 0000	
J-H(St)H grey 0.8	40 × 2 × 0.8	19.5	850	407	LKI 8009 2300 0000	
J-H(St)H grey 0.8	50 × 2 × 0.8	21.4	950	508	LKI 8009 2400 0000	
J-H(St)H BMK red 0.8	2 × 2 × 0.8	6.8	66	25	LKI 8009 3600 0000	
J-H(St)H BMK red 0.8	4 × 2 × 0.8	9.1	105	45	LKI 8009 3700 0000	
J-H(St)H BMK red 0.8	6 × 2 × 0.8	9.6	135	65	LKI 8009 3800 0000	
J-H(St)H BMK red 0.8	10 × 2 × 0.8	11.2	205	106	LKI 8009 3900 0000	

Core identification acc. to VDE 0815

The cores of a quad have black rings.

Four cores (=one quad) are coloured:

- Quad 1: ● Red
- Quad 2: ● Green
- Quad 3: ● Grey
- Quad 4: ● Yellow
- Quad 5: ○ White

Cables having more than five quads:

Consecutive quads are marked with coloured plastic tapes.

Further designs upon request

Power cables

DIN VDE 0276-604



REACH

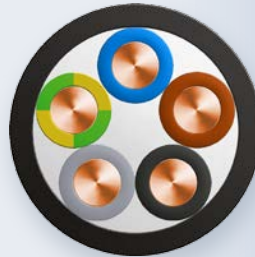

Advantages

- High safety standards
- Halogen-free
- In compliance with REACH directive

N2XH

Applications

Power cable 0.6 / 1 kV for fixed installation in cable systems with improved fire performance. For:

- power stations
- buildings and areas where people gather and for protection of valuables

Construction

- | | |
|-----------------------|--------------------------------------|
| ■ Conductors | Bare annealed copper |
| ■ Insulation | Polyethylene cross-linked |
| ■ Inner covering | Tape or filler |
| ■ Core identification | Acc. to VDE 0276-604 resp. HD 308 S2 |
| ■ Sheath | BETAflam® copolymer |
| ■ Sheath colour | Black |

Electrical characteristics

Rated voltage	U_0/U 0.6 / 1 kV
Test voltage	4 kV with 50 Hz

Thermal characteristics

Operation temperature	-30 °C up to +90 °C
Laying temperature	-5 °C up to +70 °C
Short circuit temperature	+250 °C (temperature peak < 5 s)

Bending radius

cable design	single core	multiple core
during laying	$> 15 \times \text{outer } \emptyset$	$> 12 \times \text{outer } \emptyset$
fixed	$> 8 \times \text{outer } \emptyset$	$> 7 \times \text{outer } \emptyset$

Laying conditions

- Fixed installation indoor, in air or concrete
- Laying in earth or water only in water-proof dry tubes
- Outdoor laying only when protected from direct sunlight and other external impacts

Standards / Material properties

- Halogen-free: IEC 60754-1, EN 50267-2-1, VDE 0482-267-2-1
- No corrosive gases: IEC 60754-2, EN 50267-2-2, VDE 0482-267-2-2
- Low smoke density: IEC 61034-1 and -2, EN 61034-1 and -2, VDE 0482-1034-1 and -2
- Flame retardant: IEC 60332-1, EN 60332-1, VDE 0482-332-1
- No flame propagation: IEC 60332-3-10 and -3-24, EN 60332-3-10, -24, VDE 0482-332-3-24

Cable type	Construction n × mm ²	Core function	Outer Ø mm	Weight kg / km	Cu factor kg / km	Order no.	
						Germany	Switzerland
N2XH-J	1 × 4 RE	L	6.0	69	38	LKI 8004 8800 0000	
N2XH-J	1 × 6 RE	L	6.5	90	58	LKI 8004 8900 0000	
N2XH-J	1 × 10 RE	L	7.3	131	96	LKI 8004 9000 0000	
N2XH-J	1 × 16 RM	L	8.6	197	154	LKI 8004 9100 0000	
N2XH-J	1 × 25 RM	L	10.2	293	240	LKI 8004 9200 0000	
N2XH-J	1 × 35 RM	L	11.3	389	336	LKI 8004 9300 0000	
N2XH-J	1 × 50 RM	L	12.9	517	480	LKI 8004 9400 0000	
N2XH-J	1 × 70 RM	L	14.4	717	672	LKI 8004 9500 0000	
N2XH-J	1 × 95 RM	L	16.6	972	912	LKI 8004 9600 0000	
N2XH-J	1 × 120 RM	L	18.2	1215	1152	LKI 8004 9700 0000	
N2XH-J	1 × 150 RM	L	20.2	1494	1440	LKI 8004 9800 0000	
N2XH-J	1 × 185 RM	L	22.3	1855	1776	LKI 8004 9900 0000	
N2XH-J	1 × 240 RM	L	25.0	2387	2304	LKI 8005 0100 0000	
N2XH-J	1 × 300 RM	L	27.5	2971	2880	LKI 8005 0200 0000	
N2XH-J	3 × 1.5 RE	LNPE	9.3	125	43	LKI 8005 1000 0000	
N2XH-J	3 × 2.5 RE	LNPE	10.2	163	72	LKI 8005 1100 0000	
N2XH-J	3 × 4 RE	LNPE	11.2	219	115	LKI 8005 1200 0000	
N2XH-J	3 × 6 RE	LNPE	12.5	289	173	LKI 8005 1300 0000	
N2XH-J	3 × 10 RE	LNPE	13.9	431	288	LKI 8005 1400 0000	
N2XH-J	3 × 16 RM	LNPE	17.7	638	461	LKI 8005 1500 0000	
N2XH-J	4 × 1.5 RE	3LPE	10.1	147	58	LKI 8005 3400 0000	
N2XH-J	4 × 2.5 RE	3LPE	11.0	195	96	LKI 8005 3500 0000	301160
N2XH-J	4 × 4 RE	3LPE	12.1	266	154	LKI 8005 3600 0000	
N2XH-J	4 × 6 RE	3LPE	12.3	355	230	LKI 8005 3700 0000	303889
N2XH-J	4 × 10 RE	3LPE	15.4	547	384	LKI 8005 3800 0000	
N2XH-J	4 × 16 RM	3LPE	18.6	839	614	LKI 8005 3900 0000	
N2XH-J	4 × 25 RM	3LPE	23.5	1294	960	LKI 8005 4000 0000	
N2XH-J	4 × 35 RM	3LPE	26.0	1605	1344	LKI 8005 4100 0000	
N2XH-J	4 × 50 RM	3LPE	29.4	2154	1920	LKI 8005 4200 0000	
N2XH-J	4 × 70 RM	3LPE	34.4	3047	2688	LKI 8005 4300 0000	
N2XH-J	4 × 95 RM	3LPE	38.6	4102	3648	LKI 8005 4400 0000	
N2XH-J	4 × 120 RM	3LPE	42.4	5062	4608	LKI 8005 4600 0000	
N2XH-J	4 × 150 RM	3LPE	47.2	6256	5760	LKI 8005 4700 0000	
N2XH-J	4 × 185 RM	3LPE	52.0	7751	7104	LKI 8005 4800 0000	
N2XH-J	5 × 1.5 RE	3LNPE	10.9	174	72	LKI 8005 5000 0000	
N2XH-J	5 × 2.5 RE	3LNPE	11.9	233	120	LKI 8005 5100 0000	
N2XH-J	5 × 4 RE	3LNPE	13.1	319	192	LKI 8005 5200 0000	
N2XH-J	5 × 6 RE	3LNPE	14.4	427	288	LKI 8005 5300 0000	
N2XH-J	5 × 10 RE	3LNPE	16.8	682	480	LKI 8005 5400 0000	

-J = with gn/ye conductor ●	L = colour phase conductor br/bk/gr ● ● ●
-O = without gn/ye conductor	N = colour neutral conductor bl ●
RE = round solid, class 1	NR = colour phase conductors bk ● / numbered
RM = round stranded, class 2	PE = colour earth conductor gn/ye ●

Further designs upon request

Cable type	Construction	Core function	Outer Ø	Weight	Cu factor	Order no.	
						Germany	Switzerland
	$n \times \text{mm}^2$		mm	kg / km	kg / km		
N2XH-J	5 × 16 RE	3LNPE	19.2	1036	768	LKI 8005 5500 0000	
N2XH-J	5 × 25 RM	3LNPE	24.9	1584	1200	LKI 8005 5600 0000	
N2XH-J	7 × 1.5 RE	NRPE	11.7	214	101	LKI 8005 6100 0000	
N2XH-J	7 × 2.5 RE	NRPE	12.8	291	168	LKI 8005 6200 0000	
N2XH-J	10 × 1.5 RE	NRPE	14.4	299	144	LKI 8005 6600 0000	
N2XH-J	10 × 2.5 RE	NRPE	16.2	419	240	LKI 8005 6700 0000	
N2XH-J	12 × 1.5 RE	NRPE	14.9	342	173	LKI 8005 6800 0000	
N2XH-J	12 × 2.5 RE	NRPE	16.6	480	288	LKI 8005 6900 0000	
N2XH-J	24 × 1.5 RE	NRPE	20.4	625	346	LKI 8005 8100 0000	
N2XH-J	30 × 1.5 RE	NRPE	21.5	738	432	LKI 8005 8300 0000	
N2XH-J	30 × 2.5 RE	NRPE	23.9	1045	720	LKI 8005 8400 0000	

-J = with gn/ye conductor ●
 -O = without gn/ye conductor
 RE = round solid, class 1
 RM = round stranded, class 2

L = colour phase conductor br/bk/gr ● ● ●
 N = colour neutral conductor bl ●
 NR = colour phase conductors bk ● / numbered
 PE = colour earth conductor gn/ye ●

Further designs upon request

Power cables

DIN VDE 0276-604



REACH

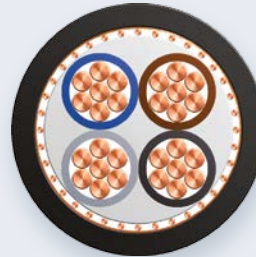
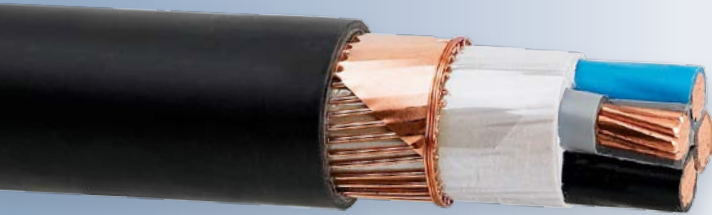

Advantages

- High safety standards
- Halogen-free
- In compliance with REACH directive

N2XCH

Applications

Power cable 0.6/1 kV with concentric conductor for fixed installation in cable systems with improved fire performance.

For:

- power stations
- buildings and areas where people gather and for protection of valuables

Construction

- | | |
|------------------------|---|
| ■ Conductors | Bare annealed copper |
| ■ Insulation | Polyethylene cross-linked |
| ■ Inner covering | Tape or filler |
| ■ Concentric conductor | Copper wires, with helix of copper tape |
| ■ Sheath | BETAflam® copolymer |
| ■ Core identification | acc. to VDE 0276-604 resp. HD 308 S2 |
| ■ Sheath colour | Black |

Electrical characteristics

Rated voltage	U_0/U 0.6/1 kV
Test voltage	4 kV with 50 Hz

Thermal characteristics

Operation temperature	-30 °C up to +90 °C
Laying temperature	-5 °C up to +70 °C
Short circuit temperature	+250 °C (temperature peak < 5 s)

Bending radius

cable design	single core	multiple core
during laying	$> 15 \times \text{outer } \varnothing$	$> 12 \times \text{outer } \varnothing$
fixed	$> 8 \times \text{outer } \varnothing$	$> 7 \times \text{outer } \varnothing$

Laying conditions

- Fixed installation indoor, in air or concrete
- Laying in earth or water only in water-proof dry tubes
- Outdoor laying only when protected from direct sunlight and other external impacts

Standards / Material properties

- Halogen-free: IEC 60754-1, EN 50267-2-1, VDE 0482-267-2-1
- No corrosive gases: IEC 60754-2, EN 50267-2-2, VDE 0482-267-2-2
- Low smoke density: IEC 61034-1 and -2, EN 61034-1 and -2, VDE 0482-1034-1 and -2
- Flame retardant: IEC 60332-1, EN 60332-1, VDE 0482-332-1
- No flame propagation: IEC 60332-3-10 and -3-24, EN 60332-3-10, -24, VDE 0482-332-3-24

Cable type	Construction n × mm ²	Core function	Outer Ø mm	Weight kg / km	Cu factor kg / km	Order no.	
						Germany	Switzerland
N2XCH	2 × 1.5 RE / 1.5	LN	11.1	172	52	LKI 8007 0300 0000	
N2XCH	2 × 2.5 RE / 2.5	LN	11.9	213	80	LKI 8007 0400 0000	
N2XCH	3 × 1.5 RE / 1.5	3L	11.1	190	66	LKI 8007 1100 0000	
N2XCH	3 × 2.5 RE / 2.5	3L	12.0	240	104	LKI 8007 1200 0000	
N2XCH	3 × 4 RE / 4	3L	13.4	314	161	LKI 8007 1300 0000	
N2XCH	3 × 6 RE / 6	3L	14.7	410	240	LKI 8007 1400 0000	
N2XCH	3 × 10 RE / 10	3L	16.5	600	408	LKI 8007 1500 0000	
N2XCH	3 × 16 RM / 16	3L	20.1	896	643	LKI 8007 1600 0000	
N2XCH	3 × 25 RM / 16	3L	24.4	1360	902	LKI 8007 1700 0000	
N2XCH	3 × 35 RM / 16	3L	26.7	1795	1190	LKI 8007 1800 0000	
N2XCH	4 × 1.5 RE / 1.5	3LN	11.9	217	81	LKI 8007 2600 0000	
N2XCH	4 × 2.5 RE / 2.5	3LN	12.8	275	128	LKI 8007 2700 0000	
N2XCH	4 × 4 RE / 4	3LN	14.3	365	200	LKI 8007 2800 0000	
N2XCH	4 × 6 RE / 6	3LN	15.8	479	297	LKI 8007 2900 0000	
N2XCH	4 × 10 RE / 10	3LN	18.0	709	504	LKI 8007 3000 0000	
N2XCH	4 × 16 RM / 16	3LN	21.7	1068	796	LKI 8007 3100 0000	306525
N2XCH	4 × 25 RM / 16	3LN	26.5	1526	1142	LKI 8007 3200 0000	
N2XCH	4 × 35 RM / 16	3LN	29.0	1814	1526	LKI 8007 3300 0000	
N2XCH	4 × 50 SM / 25	3LN	29.6	2405	2203	LKI 8007 6100 0000	
N2XCH	4 × 70 SM / 35	3LN	34.7	3378	3082	LKI 8007 6200 0000	
N2XCH	4 × 95 SM / 50	3LN	38.5	4568	4208	LKI 8007 6300 0000	
N2XCH	4 × 120 SM / 70	3LN	43.1	5773	5388	LKI 8007 6400 0000	
N2XCH	4 × 150 SM / 70	3LN	47.2	6921	6540	LKI 8007 6500 0000	
N2XCH	4 × 185 SM / 95	3LN	51.6	8666	8159	LKI 8007 6600 0000	
N2XCH	4 × 240 SM / 120	3LN	57.3	11167	10546	LKI 8007 6700 0000	
N2XCH	7 × 1.5 RE / 2.5	NR	13.5	295	133	LKI 8007 4100 0000	
N2XCH	7 × 2.5 RE / 2.5	NR	14.6	378	200	LKI 8007 4200 0000	
N2XCH	12 × 1.5 RE / 2.5	NR	16.9	437	205	LKI 8007 4700 0000	
N2XCH	12 × 2.5 RE / 4	NR	18.8	589	334	LKI 8007 4800 0000	
N2XCH	24 × 1.5 RE / 6	NR	22.6	764	413	LKI 8007 5500 0000	
N2XCH	30 × 1.5 RE / 6	NR	23.7	880	499	LKI 8007 5700 0000	
N2XCH	30 × 2.5 RE / 10	NR	26.5	1238	840	LKI 8007 5800 0000	

RE = round solid, class 1

RM = round stranded, class 2

SM = sector shaped, stranded
class 2

L = colour phase conductor br/bk/gr ● ● ●

N = colour neutral conductor bl ●

NR = colour phase conductors bk ● / numbered

Further designs upon request

Installation cables

DIN VDE 0250-214



REACH

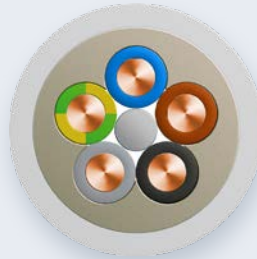

Advantages

- Cross-linked insulation
- Flame retardant
- Halogen-free
- In compliance with REACH directive

NHXMH

Applications

Halogen-free cable:

- for use in buildings and areas where people gather and in facilities with high requirements regarding safeguarding of valuables
- for fixed installation in cable ducts and tubes in dry, damp and wet rooms.

Construction

- | | |
|-----------------------|------------------------------------|
| ■ Conductors | Bare annealed copper |
| ■ Insulation | Polymer halogen-free, cross-linked |
| ■ Inner covering | filler halogen-free |
| ■ Sheath | Polymer compound |
| ■ Core identification | acc. to VDE 0293 resp. HD 308 S2 |
| ■ Sheath colour | Light grey |

Electrical characteristics

Rated voltage	U_0/U 300/500 V
Test voltage	2 kV with 50 Hz

Thermal characteristics

Operation temperature	-30 °C up to +70 °C
Laying temperature	-5 °C up to +50 °C
Short circuit temperature	+250 °C (temperature peak < 5 s)

Bending radius

cable design	single core	multiple core
during laying	$> 15 \times \text{outer } \varnothing$	$> 12 \times \text{outer } \varnothing$
fixed	$> 8 \times \text{outer } \varnothing$	$> 7 \times \text{outer } \varnothing$

Laying conditions

- Fixed installation indoor, in masonry and concrete, except the laying in compressed concrete and the laying in the ground
- Suitable for outdoor laying without direct sun exposure

Standards / Material properties

- Halogen-free: IEC 60754-1, EN 50267-2-1, VDE 0482-267-2-1
- No corrosive gases: IEC 60754-2, EN 50267-2-2, VDE 0482-267-2-2
- Low smoke density: IEC 61034-1 and -2, EN 61034-1 and -2, VDE 0482-1034-1 and -2
- Flame retardant: IEC 60332-1, EN 60332-1, VDE 0482-332-1
- No flame propagation: IEC 60332-3-10 and -3-24, EN 60332-3-10, -24, VDE 0482-332-3-24

Cable type	Construction	Core function	Outer Ø	Weight	Cu factor	Order no.	
						Germany	Switzerland
	$n \times \text{mm}^2$		mm	kg / km	kg / km		
NHXMH-J	1 × 4 RE	PE	6.4	72	38	LKI 8007 7500 0000	
NHXMH-J	1 × 6 RE	PE	6.9	93	58	LKI 8007 7600 0000	
NHXMH-J	1 × 10 RE	PE	7.9	138	96	LKI 8007 7700 0000	
NHXMH-J	1 × 16 RM	PE	9.3	205	154	LKI 8007 7800 0000	
NHXMH-J	3 × 1.5 RE	LNPE	8.3	121	43	LKI 8007 8400 0000	
NHXMH-J	3 × 2.5 RE	LNPE	9.1	160	72	LKI 8007 8500 0000	
NHXMH-J	3 × 4 RE	LNPE	11.3	226	115	LKI 8007 8600 0000	
NHXMH-J	3 × 6 RE	LNPE	12.2	310	173	LKI 8007 8700 0000	
NHXMH-J	3 × 10 RE	LNPE	14.4	469	288	LKI 8007 8800 0000	
NHXMH-J	4 × 1.5 RE	3LPE	9.0	143	58	LKI 8007 9200 0000	
NHXMH-J	4 × 2.5 RE	3LPE	10.0	191	96	LKI 8007 9300 0000	
NHXMH-J	4 × 4 RE	3LPE	12.0	284	154	LKI 8007 9400 0000	
NHXMH-J	4 × 6 RE	3LPE	13.3	376	230	LKI 8007 9500 0000	
NHXMH-J	4 × 10 RE	3LPE	15.8	575	384	LKI 8007 9600 0000	
NHXMH-J	4 × 16 RM	3LPE	19.1	887	614	LKI 8007 9700 0000	
NHXMH-J	5 × 1.5 RE	3LNPE	9.8	167	72	LKI 8008 0000 0000	
NHXMH-J	5 × 2.5 RE	3LNPE	10.8	226	120	LKI 8008 0100 0000	
NHXMH-J	5 × 4 RE	3LNPE	13.0	338	192	LKI 8008 0200 0000	
NHXMH-J	5 × 6 RE	3LNPE	14.4	451	288	LKI 8008 0300 0000	
NHXMH-J	5 × 10 RE	3LNPE	17.2	705	480	LKI 8008 0400 0000	
NHXMH-J	5 × 16 RM	3LNPE	22.2	1096	768	LKI 8008 0500 0000	
NHXMH-J	5 × 25 RM	3LNPE	26.0	1690	1200	LKI 8008 0600 0000	
NHXMH-J	7 × 1.5 RE	NRPE	10.5	204	101	LKI 8008 0800 0000	
NHXMH-J	7 × 2.5 RE	NRPE	11.8	293	168	LKI 8008 0900 0000	
NHXMH-J	10 × 1.5 RE	NRPE	12.8	325	144	LKI 8008 1100 0000	
NHXMH-J	12 × 1.5 RE	NRPE	13.2	361	173	LKI 8008 1300 0000	

-J = with gn/ye conductor ●
 -O = without gn/ye conductor
 RE = round solid, class 1
 RM = round stranded, class 2

L = colour phase conductor br/bk/gr ● ● ●
 N = colour neutral conductor bl ●
 NR = colour phase conductors bk ● / numbered
 PE = colour earth conductor gn/ye ●

Further designs upon request

Technical informations











Technical informations	page
Current rating	66
Fire load	68
Core identification acc. to HD 308 S2	70
Halogen-free	71
Degree of acidity of combustion gases	71
Smoke density	72
Flame retardant	72
No flame propagation	73
Circuit integrity under fire	73
Fire performance according to CPR (Construction Product Regulation)	74
Circuit integrity with mechanical shock	76
System integrity	76
Duration of system circuit integrity in the building	77
BETAflam® Approvals	78

Current rating









Multicore cables, conductor temperature max. 70 °C

with copper conductors, ambient temperature 30 °C

Construction	Mode of laying A Cables in tubes in insulated walls		Mode of laying B In tubes, on or in wall or in closed conduits		Mode of laying C Clipped direct or laid in open troughs or ducts		Mode of laying E Open laying on perforated trays or in air	
	2	3	2	3	2	3	2	3
Number of energized cores								
mm ²	A	A	A	A	A	A	A	A
1.5	15	13	16	15	19	17	22	18
2.5	18	17	23	20	27	24	30	25
4	25	23	30	27	36	32	40	34
6	32	29	38	34	46	41	51	43
10	43	39	52	46	63	57	70	60
16	57	52	69	62	85	76	94	80
25	75	68	90	80	112	96	119	101
35	92	83	111	99	138	119	148	126
50	110	99	133	118	168	144	180	153
70	139	125	168	149	213	184	232	196
95	167	150	201	179	258	223	282	238
120	192	172	232	206	299	259	328	276
150	219	223	258	225	344	299	379	319
185	248	245	294	255	392	341	434	364
240	291	261	344	297	461	403	514	430

Single core cables, conductor temperature max. 70 °C

with copper conductors, ambient temperature 30 °C

Construction	Mode of laying A1 Cables in tubes in insulated walls		Mode of laying B1 In tubes, on or in wall or in closed conduits		Mode of laying C Clipped direct or laid in open troughs or ducts		Mode of laying F Open laying on perforated trays or in air	
	2	3	2	3	2	3	2	3
Anzahl belastete Adern								
mm ²	A	A	A	A	A	A	A	A
240	320	286	400	346	461	403	546	485
300	367	328	458	394	530	464	629	561
400	396	355	500	434	580	524	754	656
500	432	387	536	477	638	580	868	749

Valid for continuous operation. AC 50–60 Hz, DC

For operating conditions different from the above, corrective factors must be taken into account (multiple cables, other load factors, ambient temperatures or multicore cables).

Multicore cables, conductor temperature max. 90 °C

with copper conductors, ambient temperature 30 °C

Construction	Mode of laying A Cables in tubes in insulated walls		Mode of laying B In tubes, on or in wall or in closed conduits		Mode of laying C Clipped direct or laid in open troughs or ducts		Mode of laying E Open laying on perforated trays or in air	
	Anzahl belastete Adern							
mm ²	A	A	A	A	A	A	A	A
1.5	18	16	22	19	24	22	26	23
2.5	25	22	30	26	33	30	36	32
4	33	30	40	35	45	40	49	42
6	42	38	51	44	58	52	63	54
10	57	51	69	60	80	71	86	75
16	76	68	91	80	107	96	115	100
25	99	89	119	105	138	119	149	127
35	121	109	146	128	171	147	185	158
50	145	130	175	154	209	179	225	192
70	183	164	221	194	269	229	289	246
95	220	197	265	233	328	278	352	298
120	253	227	305	268	382	322	410	346
150	290	259	334	300	441	371	473	399
185	329	295	384	340	506	424	542	456
240	386	346	459	398	599	500	641	538

Single core cables, conductor temperature max. 90 °C

with copper conductors, ambient temperature 30 °C

Construction	Mode of laying A1 Cables in tubes in insulated walls		Mode of laying B1 In tubes, on or in wall or in closed conduits		Mode of laying C Clipped direct or laid in open troughs or ducts		Mode of laying F Open laying on perforated trays or in air	
	Anzahl belastete Adern							
mm ²	A	A	A	A	A	A	A	A
240	424	380	528	450	599	500	679	607
300	486	435	603	514	693	576	783	703
400	538	478	690	584	783	670	940	823
500	580	516	749	645	852	760	1083	946

Valid for continuous operation. AC 50–60 Hz, DC

For operating conditions different from the above, corrective factors must be taken into account (multiple cables, other load factors, ambient temperatures or multicore cables).

Fire load

BETAflam® Safety and installation cables

Construction	NHXH FE180 / E30, E60, E90	NHXCH FE180 / E30, E60, E90	N2XH	N2XCH	NHXMH	FE0	INSTAflex	FE5	FE180 / E30	FE180 / E30-CLE
n × mm ²	kWh/m	kWh/m	kWh/m	kWh/m	kWh/m	kWh/m	kWh/m	kWh/m	kWh/m	kWh/m
1 × 4 ...	0.26		0.17		0.42	0.12		0.16	0.11	
1 × 6 ...	0.28		0.18		0.44	0.15		0.20	0.13	
1 × 10 ...	0.32		0.21		0.53	0.20		0.25	0.17	
1 × 16 ...	0.38		0.29		0.64	0.32	0.42	0.38	0.23	
1 × 25 ...	0.48		0.39			0.45	0.54	0.42	0.33	
1 × 35 ...	0.53		0.46			0.56	0.67	0.57	0.41	
1 × 50 ...	0.65		0.53			0.65		0.66	0.52	
1 × 70 ...	0.75		0.55			0.92		0.88	0.68	
1 × 95 ...	0.96		0.63			1.15		1.10	0.92	
1 × 120 ...	1.08		0.72			1.35		1.30	1.07	
1 × 150 ...	1.26		0.90			1.58		1.56	1.24	
1 × 185 ...	1.52		1.08			1.91		1.84	1.49	
1 × 240 ...	1.84		1.22			2.32		2.23	1.82	
1 × 300 ...	2.25		1.32			2.94		2.83	2.31	
1 × 400 ...	2.95									
1 × 500 ...	3.47									
2 × 1.5 ...	0.65	1.10		0.44	0.36	0.16		0.21	0.26	0.61
2 × 2.5 ...	0.71	1.29		0.49	0.42	0.21		0.26	0.31	0.70
2 × 4 ...	0.78	1.44				0.31			0.31	0.71
2 × 6 ...	0.77	1.51				0.44			0.39	0.83
2 × 10 ...	0.90	1.73				0.59			0.57	1.07
2 × 16 ...	1.06								0.79	1.42
2 × 25 ...	1.48								1.11	1.86
3 × 1.5 ...	0.59	1.11	0.48	0.48	0.42	0.20	0.33	0.25	0.23	0.60
3 × 2.5 ...	0.65	1.11	0.56	0.55	0.47	0.26	0.46	0.31	0.28	0.68
3 × 4 ...	0.71	1.23	0.65	0.64	0.61	0.32		0.37	0.29	0.70
3 × 6 ...	0.77	1.34	0.73	0.72	0.78	0.41		0.46		0.85
3 × 10 ...	0.88	1.54	0.86	0.85	1.10	0.58				1.06
3 × 16 ...	1.29	2.13	1.19	1.18						1.40
3 × 25 ...	1.68	3.00		1.59						
3 × 35 ...	1.90	3.24		1.91						
3 × 50 ...	2.42	4.20								
3 × 70 ...	2.91	5.03								
3 × 95 ...	3.54	6.13								
3 × 120 ...	4.02	4.31								
3 × 150 ...	4.95	9.92								
3 × 185 ...	5.93	10.26								
3 × 240 ...	7.52	12.69								
3 × 25 + 16 ...	1.93									
3 × 35 + 16 ...	2.22									
3 × 50 + 25 ...	2.83									
3 × 70 + 35 ...	3.40									
3 × 95 + 50 ...	4.50									
3 × 120 + 70 ...	4.93									
3 × 150 + 70 ...	5.89									
3 × 185 + 95 ...	7.24									
3 × 240 + 120 ...	8.76									

Construction	NHXH FE180 / E30, E60, E90	NHXCH FE180 / E30, E60, E90	N2XH	N2XCH	NHXMH	FE0	INSTAflex	FE5	FE180 / E30	FE180 / E30-CLE
n × mm ²	kWh / m	kWh / m	kWh / m	kWh / m	kWh / m	kWh / m	kWh / m	kWh / m	kWh / m	kWh / m
4 × 1.5 ...	0.73	0.78	0.54	0.54	0.47	0.25	0.39	0.30	0.29	0.68
4 × 2.5 ...	0.79	1.24	0.63	0.62	0.56	0.34	0.56	0.40	0.36	0.79
4 × 4 ...	0.88	1.39	0.73	0.72	0.78	0.41	0.66	0.46	0.36	0.80
4 × 6 ...	0.97	1.55	0.82	0.82	0.94	0.54	0.71	0.57	0.45	0.94
4 × 10 ...	1.01	1.16	0.99	1.00	1.30	0.77	1.31	0.78	0.64	1.23
4 × 16 ...	1.38	1.45	1.43	1.37	1.80	1.27	1.73	1.28	0.91	1.63
4 × 25 ...	2.03	2.21	1.97	1.94	2.60	1.84	2.53	2.06	1.37	2.23
4 × 35 ...	2.35	3.76	2.31	2.27	3.10	2.25	3.22	2.44	1.93	2.91
4 × 50 ...	3.01	4.79	2.89	2.77		3.08		2.97	2.62	3.75
4 × 70 ...	3.63	5.75	3.00			4.43		4.28	3.55	4.86
4 × 95 ...	4.66	7.24	3.90			5.54		5.35	4.72	6.48
4 × 120 ...	5.10	5.42	4.77					6.53	5.34	7.28
4 × 150 ...	6.19	6.53	6.81					7.38	6.50	9.06
4 × 185 ...	7.57	7.98						9.04	7.46	10.25
4 × 240 ...	9.47	9.93						11.03	9.64	13.65
5 × 1.5 ...	0.89		0.62		0.56	0.31	0.46	0.35	0.36	0.79
5 × 2.5 ...	0.97		0.70		0.64	0.43	0.65	0.45	0.45	0.92
5 × 4 ...	1.04		0.82		0.98	0.51	0.80	0.52	0.46	0.94
5 × 6 ...	1.15		0.91		1.10	0.67	0.89	0.65	0.58	1.12
5 × 10 ...	1.31		1.11		1.50	0.99	1.63	0.90	0.81	1.45
5 × 16 ...	1.66		1.68		2.20	1.57	2.22	1.48	1.23	2.04
5 × 25 ...	2.14		2.35		3.10	2.32	3.22	2.09	1.68	2.68
5 × 35 ...	2.87					2.88	4.13	2.95	2.55	3.63
5 × 50 ...	3.69					3.77		3.46	3.25	4.50
5 × 70 ...	4.41					5.45		5.01	4.30	6.00
5 × 95 ...	5.77					7.05		6.42	5.79	7.74
5 × 120 ...	6.77									
7 × 1.5 ...	1.00	1.05	0.51	5.00	0.64	0.38		0.43	0.39	0.85
7 × 2.5 ...	1.09	1.14	0.58	0.57	0.81	0.51		0.56	0.50	1.01
7 × 4 ...	1.21	1.27				0.61			0.52	1.04
12 × 1.5 ...	1.51	1.56	0.76	0.74		0.63			0.57	1.04
12 × 2.5 ...	1.66	1.72	0.88	0.86					0.73	1.26
19 × 1.5 ...	2.12					0.92				
19 × 2.5 ...	2.33									
24 × 1.5 ...	2.66	2.77	1.31	1.25		1.15			1.18	
24 × 2.5 ...	2.99	3.06	1.53						1.44	
30 × 1.5 ...	3.16	3.28	1.54	1.47		1.42				
30 × 2.5 ...	3.56	3.69	1.80	1.77						

1 kWh = 3.6 MJ

Nominal figures only

Fire load

BETAflam® Safety and installation cables

Construction	JE-H(St)H FE180/ E30, E60, E90	JE-H(St)HRH FE180 armoured
n × 2 × mm Ø	kWh / m	kWh / m
1 × 2 × 0.8	0.15	0.34
2 × 2 × 0.8	0.20	0.41
4 × 2 × 0.8	0.33	0.66
8 × 2 × 0.8	0.64	1.22
12 × 2 × 0.8	0.81	1.45
16 × 2 × 0.8	1.02	1.85
20 × 2 × 0.8	1.24	2.12
32 × 2 × 0.8	2.15	3.69
40 × 2 × 0.8	2.45	4.10
52 × 2 × 0.8	3.04	4.82
80 × 2 × 0.8	4.23	6.15
100 × 2 × 0.8	5.22	7.33
1 × 2 × 1.0 mm ²	0.18	
1 × 2 × 1.5 mm ²	0.20	
2 × 2 × 1.5 mm ²	0.27	
1 × 2 × 2.5 mm ²	0.23	

1 kWh = 3.6 MJ

Nominal figures only

Construction	J-H(St)H 0.6 mm Ø	J-H(St)H 0.8 mm Ø
n × 2 × mm Ø	kWh / m	kWh / m
2 × 2 × ...	0.15	0.17
4 × 2 × ...	0.23	0.27
6 × 2 × ...	0.26	0.31
10 × 2 × ...	0.34	0.42
20 × 2 × ...	0.55	0.70
30 × 2 × ...	0.69	0.96
40 × 2 × ...	0.83	1.17
50 × 2 × ...	1.04	1.38

Core identification acc. to HD 308 S2



Cables with green-yellow core

No. of cores	Core function	Core colour
1	PE	green-yellow
2		
3	LNPE	brown, blue, green-yellow
4	3LPE	brown, black, grey, green-yellow
5	3LNPE	brown, black, grey, blue, green-yellow
≥6	NRPE	black, numbered, green-yellow

Cables without green-yellow core

Cables with concentric conductor

No. of cores	Core function	Core colour
1	L	black
2	LN	brown, blue
3	3L	brown, black, grey
4	3LN	brown, black, grey, blue
5		
≥6	NR	black, numbered

Halogen-free

The halogens are the elements of the 7th group in the Periodic Table of Elements:

- **Chlorine (Cl)**
- **Fluorine (F)**
- **Bromine (Br)**
- **Jodine (I)**

Halogen-free cables must be free of chlorine, fluorine and bromine (PVC cables contain halogen, PVC = Polyvinylchloride).

The halogens are an integrated component of many acids.

- **HCl = Hydrochloric acid, salt acid**
- **HF = Hydrogenfluorid**
- **HBr = Hydrogenbromid**

The most popular plastic containing halogens is PVC (polyvinylchloride). In case of fire or at high temperature PVC starts to degradate. Hydrochloric acid and other fission products are generated and leads to extremely aggressive corrosion. Therefore the current trend is to replace the halogen containing plastics with halogen-free ones. For instance PVC is currently being replaced at a large scale with polyolefin i.e. polyethylene.

Thanks to halogen-free cables the formation of corrosive and toxic gases can be prevented.

Test procedures

Between 0.5 g and 1.0 g of material is placed into a tube furnace. Over a period of 40 minutes, the temperature inside of the tube furnace is steadily increased to $800\text{ }^{\circ}\text{C} \pm 10\text{ }^{\circ}\text{C}$, the temperature is then maintained for a further 20 minutes. The gases produced are absorbed into a defined catch solution. The test is considered to be passed if the amount of halogen acid evolved does not exceed 0.5 % or 5 mg/g.

Test standards

IEC 60754-1, EN 50267-2-1

Degree of acidity of combustion gases

Corrosive gases act with moisture to produce aggressive acids which corrode metal parts and cause extensive long-term damage, even though the fire damage may only be limited; this is because corrosive gases often spread throughout a building through the ventilation system or withing whole installations. The damage may not be limited to the area immediately affected by the fire. Electronic units and electronic contacts are particularly vulnerable, as are free-standing or concrete enclosed steel constructions.

Test procedures

1000 mg insulation material is burned in a combustion furnace at $\geq 935\text{ }^{\circ}\text{C}$ with pre-defined air supply for over 30 minutes. By means of two gas washing containers, held in the airflow the conductivity and the pH-value are measured. Like that even small quantities of halogen containing substances can be detected and proven.

The test is considered to be passed if

- **the PH-value > 4.3**
- **the conductivity < 10 $\mu\text{S}/\text{mm}$**

Test standards

IEC 60754-2, EN 50267-2-2

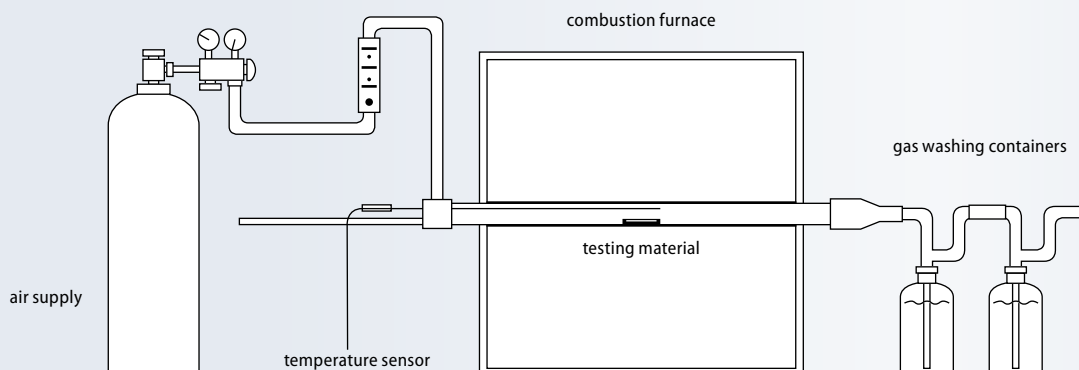

Smoke density

The formation of smoke has several unpleasant consequences. On one hand it considerably lowers the visibility in a fire event, thus impeding the people trapped inside closed rooms escape of and the efforts of the firemen to carry on their rescue and fire fighting actions. On the other hand it produces smoke poisoning because of the carbon monoxide. Regarding the formation of the combustion gases the PVC comes off quite badly. However, this cannot be blamed on the PVC, as frequently assumed. In fact, it is caused by the additives included in the PVC – particularly the softening agents, which normally lead to considerable smoke production.

Test procedures

The density of smoke emission can be determined by measuring of the light penetrability. Cable samples are lit with alcohol in a test chamber (cubical with an edge length of 3 m). The so formed smoke is uniformly spread by a ventilator and influences the light measuring section.

The test is considered to be passed if the following light penetrability is reached:

Hazard level	Requirements
■ HL 1	–
■ HL 2 and HL 3	60 %
■ HL 4	70 %

Test standards

IEC 61034, EN 61034

IEC 61034, EN 61034

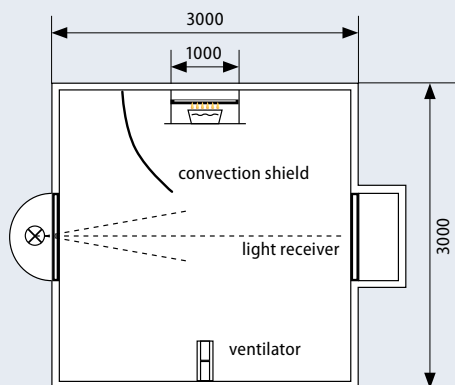

Flame retardant

Flame retardant cables are cables which, when installed as a single cable, although ignitable on exposure to flame source, will greatly reduce flame spread and self-extinguish once the flame source is removed.

However in a vertical cable bundle, e.g. in vertical risers, fire can spread along the cables (chimney effect). In order to avoid this danger, the so called «no flame propagating» cables should be used.

Test procedures

This test procedure describes the minimum requirements for flame retardant cables and it is valid for lead wires or on single cables only.

A lead wire or a cable is being aflamed with a propane-air-burner (1 kW flame).

Test duration

- $\varnothing \leq 25$ = 60 s
- $\varnothing 25 \dots 50$ = 120 s
- $\varnothing 50 \dots 75$ = 240 s
- $\varnothing > 75$ = 480 s

The burning cable should self-extinguish as soon as the fire source has been removed. The fire damage may not be higher than 60 cm.

The test is considered to be passed if the sample has not burned and the damage (carbonisation) has not reached any of the terminations of the sample (> 50 mm)..

Test standards

IEC 60332-1, EN 60332-1

IEC 60332-1-2, EN 60332-1

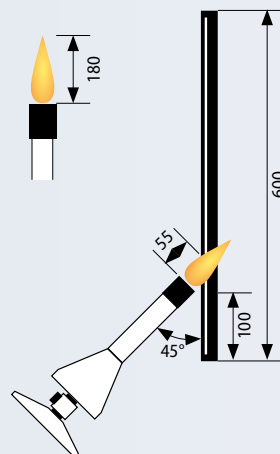

No flame propagation

No flame propagating cables are those cables which can be ignited by a flame source, however they do not allow the fire to spread even if the cable bundle is placed vertically, they are self extinguishing once the fire source is removed.

Test procedures

This test simulates the chimney effect in vertical cable installations. In a standardized cabinet the cable bundle is kept in a burner fire for 20 - 40 minutes (gas burner 75 ± 5 MJ/h). Thereby the temperature is kept constant to 750°C . Depending on the volume of the non-metal (combustible) materials per running meter it can be differentiated in the categories A F/R, A, B, C und D as follows.

Category	A F/R	A	B	C	D
■ Liter (dm^3) of insulation material per 1 m sample	7	7	3.5	1.5	0.5
■ Aflame time (min)	40	40	40	20	20

The cables must self-extinguish after removing the fire source. The fire may not have propagated any further than 2,5 m from the burner. With the BETAflam® safety cables cables this often reaches no further than 50 to 60 cm.

Test standards

Category	IEC	EN	VDE 0482
A F/R	60332-3-21	60332-3-21	part 332-3-21
A	60332-3-22	60332-3-22	part 332-3-22
B	60332-3-23	60332-3-23	part 332-3-23
C	60332-3-24	60332-3-24	part 332-3-24
D	60332-3-25	60332-3-25	part 332-3-25
Apparatus	60332-3-10	60332-3-10	part 332-3-10

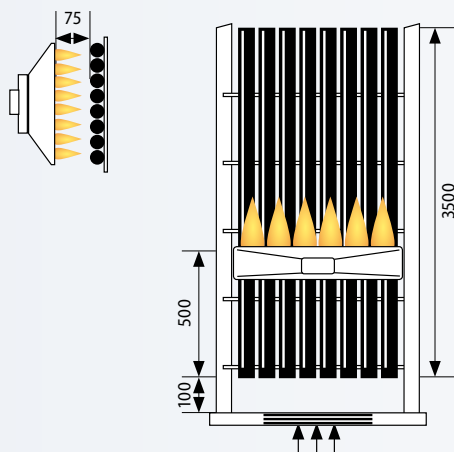

Circuit integrity under fire

The circuit integrity indicates, how long a free cable retains its isolation in a fire without causing a short-circuit. According to its international standard, a cable is laid horizontally over a burner for three hours. The temperature is set at 800°C . The circuit integrity is designated with FE (e.g. FE180 = circuit integrity of 180 min): BETAflam® FE180 / E30

Test procedures

The sample is fastened at defined distances above the burner. The conductor is connected to a power source at nominal voltage via an 2 A fuse.

The test is considered to be passed, if during the test no short circuit or circuit interruption occurs.

Test standards

IEC 60331-11 and -21, DIN VDE 0472-814

IEC 60331-11 and -21, DIN VDE 0472-814

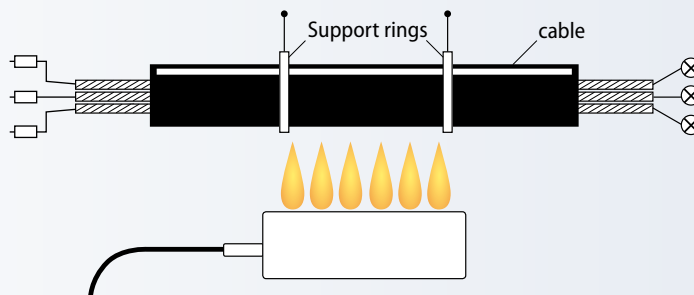

Fire performance according to CPR

CPR – Construction Product Regulation

The test according to EN 50399 allows flame spread, heat release, fire growth rate (FIGRA), smoke production and flaming droplets/particles to be determined.

EN 50399



Test method EN 50399

The cables (number used dependent on cable diameter) are mounted onto a ladder in a vertical tube furnace and a flame is applied to them for 20 minutes using an air gas burner (20 kW / 30 kW). As many parameters differ from those occurring in the test according to IEC 60332-3, the results cannot be transferred.

The flue gases are collected with a defined air current (nominal value 8000 l/min) and conducted into an exhaust air duct in which the speed of the air current, the oxygen and CO₂ content, the light absorption and the temperature are measured. This allows the above values to be determined.

Euroclasses acc. to the Construction Products Regulation (CPR)

The fire performance of power, control and communication cables for fixed installation in buildings is analysed and classified according to EU Regulation 305/2011. For this purpose, the heat release and the flame spread are measured via the above test method according to EN 50399 and evaluated in order to classify the cables according to the relevant Euroclass.

The cables can also achieve additional classification according to the Construction Products Regulation if smoke production, flaming droplets and acidity are determined.

The heat released in the event of a fire, the flame spread and the fire growth rate are the criteria for the basic classification:

- **FS** → Flame Spread
- **THR** → Total Heat Release
- **HRR** → Heat Release Rate
- **FIGRA** → Fire Growth Rate

Additional criteria are as follows:

- **smoke** → determination of peak SPR (max. smoke production rate) and TSP (total smoke production) (classes s1, s1a, s1b, s2, s3)
- **droplets** → flaming droplets/particles (classes d0, d1, d2)
- **acidity** → acidity of the combustion gases (classes a1, a2, a3)

Classes of reaction-to-fire performance for electric cables

Class	Test method	Classification criteria	Additional classification
Aca	EN ISO 1716	$PCS \leq 2.0 \text{ MJ/kg (a)}$	
B1ca	EN 50399 (30 kW flame source) and EN 60332-1-2	$FS \leq 1.75 \text{ m}$ and $THR_{1200s} \leq 10 \text{ MJ}$ and $Peak-HRR \leq 20 \text{ kW}$ and $FIGRA \leq 120 \text{ Ws}^{-1}$ $H \leq 425 \text{ mm}$	Smoke production (b,e) and flaming droplets/ particles (c) and acidity (d)
	EN 50399 (20.5-kW flame source) and EN 60332-1-2	$FS \leq 1.5 \text{ m}$ and $THR_{1200s} \leq 15 \text{ MJ}$ and $Peak-HRR \leq 30 \text{ kW}$ and $FIGRA \leq 150 \text{ Ws}^{-1}$ $H \leq 425 \text{ mm}$	Smoke production (b,f) and flaming droplets/ particles (c) and acidity (d)
Cca	EN 50399 (20.5-kW flame source) and EN 60332-1-2	$FS \leq 2.0 \text{ m}$ and $THR_{1200s} \leq 30 \text{ MJ}$ and $Peak-HRR \leq 60 \text{ kW}$ and $FIGRA \leq 300 \text{ Ws}^{-1}$ $H \leq 425 \text{ mm}$	Smoke production (b,f) and flaming droplets/ particles (c) and acidity (d)
	EN 50399 (20.5-kW flame source) and EN 60332-1-2	$THR_{1200s} \leq 70 \text{ MJ}$ and $Peak-HRR \leq 400 \text{ kW}$ and $FIGRA \leq 1300 \text{ Ws}^{-1}$ $H \leq 425 \text{ mm}$	Smoke production (b,f) and flaming droplets/ particles (c) and acidity (d)
Eca	EN 60332-1-2	$H \leq 425 \text{ mm}$	
Fca	No performance determined		

Key	
a	For the entire product, with the exception of the metallic materials, and all outer components (i.e. sheath) of the product.
b	s1 = $TSP_{1200} \leq 50 \text{ m}^2$ and $Peak-SPR \leq 0.25 \text{ m}^2/\text{s}$
	s1a = s1 and transmission value according to EN 61034-2 $\geq 80 \%$
	s1b = s1 and transmission value according to EN 61034-2 $\geq 60 \%$ < 80 %
	s2 = $TSP_{1200} \leq 400 \text{ m}^2$ and $Peak-SPR \leq 1.5 \text{ m}^2/\text{s}$
	s3 = neither s1 nor s2
c	d0 = no flaming droplets/particles within 1200 s
	d1 = no flaming droplets/particles for longer than 10 s within 1200 s
	d2 = neither d0 nor d1
d	EN 50267-2-3:
	a1 = electrical conductivity < 2.5 $\mu\text{S}/\text{mm}$ and pH value > 4.3
	a2 = electrical conductivity < 10 $\mu\text{S}/\text{mm}$ and pH value > 4.3
	a3 = neither a1 nor a2. No data = no performance determined..
e	The smoke class specified for cables of class B1ca can be derived from the test according to EN 50399 (30 kW flame source).
f	The smoke class specified for cables of classes B2ca, Cca and Dca can be derived from the test according to EN 50399 (20.5 kW flame source).

Classification according to the Euroclasses also takes the results of the flame resistance test EN 60332-1-2 into account.

For classification according to the additional classes EN 61034-2 (smoke density) and EN 50267-2-3 (conductivity, pH value), the results of the relevant tests are evaluated.

The fulfilment of these requirements is verified and certified via a quality assurance system (prEN 50575) defined Europe-wide. Euroclasses Aca, B1ca, B2ca and Cca use the so-called "1+" system, Euroclasses Dca and Eca use the so-called "3" system and Euroclass Fca uses the so-called "4" system for this.

Planning

Which basic classification and which additional class is required for the different installations? There is no answer to this question as yet. It is to be expected that cables of class B2ca or Cca will be required in areas with high safety requirements (such as

ambulances). It is also to be expected that accumulation of the additional criteria in an unfavourable direction will be prohibited.

Cables of Euroclass Dca or Eca will no doubt be approved for uncritical installation areas and in general for buildings with low safety requirements.

The Construction Products Regulation regulates the marking of the products. The announcement of their use according to building legislation is subject to the construction products legislation of the individual countries. The CE marking only serves to announce the existing classification and must be accompanied by a declaration of performance made by the manufacturer/supplier.

The regulation comes into force in all member states on 1 July 2013.

Circuit integrity with mechanical shock

EN 50200, EN 50362, VDE 0482 part 200

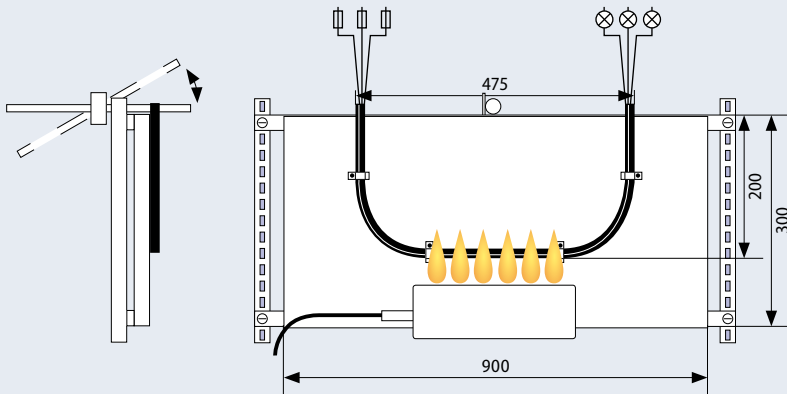

Cables for emergency circuits up to 20 mm diameter are subjected to fire with mechanical shock during a survival time of maximum 90 minutes.

Test procedures

A single cable is fastened to a test wall under conditions of minimum bending radii and is tested at a minimum test temperature of 830 °C and impacts on the cable support. During the test no rupture of conductors shall appear and voltage must be maintained.

For the purposes of the European Construction Products Directive the survival time serves to classify the cables into PH classes from PH15 to PH120.

The test is considered to be passed, if during the test no short circuit occurred.

Test standards

EN 50200, EN 50362, VDE 0482 part 200

System integrity

DIN 4102 part 12:1998-11

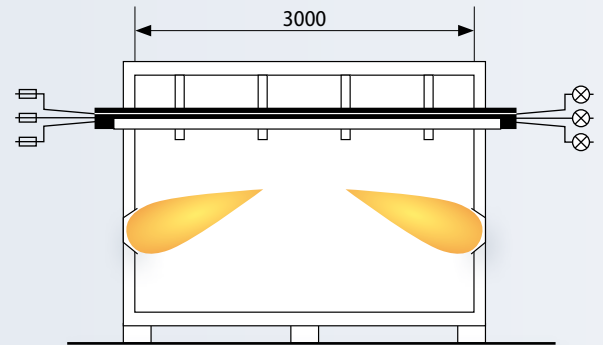

The evidence of the conservation of the functionality of cable installations in event of fire. The test involves the cable as well as the fastening resp. the laying system.

Test procedures

The profiles are installed together with the fastening system in a testing oven with a minimum length of 3 m. The conductors are connected to a 400 V (for control cables 110 V) power source and fused with 2 A. The testing temperature is 850 °C up to 1000 °C.

The test is considered to be passed, if during the test there is no short circuit or circuit interruption in the cable system. The classification E30, E60, E90 bases on the least favourable result obtained on at least two identical specimens. The heat-induced increase in conductor resistance is not taken into account during the test.

Test standards

DIN 4102 part 12:1998-11

Duration of system circuit integrity in the building



The duration of the system circuit integrity depends on how long the supply of electrical services must continue in the event of a fire. National legislations in most countries provide requirements for safety systems which have to be met.

Evacuation

In many countries a duration of 30 minutes is considered sufficient for alarm and evacuation of people. Compliance with this requirement with regard to the systems (fire alarm systems, emergency lighting, passenger hoists, smoke exhaust, voice alarm and acoustic signalling, escape route signalling) can be achieved by means of a «Class E30» cable system.

After people have been brought to safety additional time must be calculated for the fire fighters to tackle the blaze. As a rule, 90 minutes following the outbreak of the fire should be sufficient to extinguish it. Power required by the electrical systems (e.g. water pumps, fire brigade lifts, mechanical smoke extraction systems) can be satisfied using class E90 cable systems.

Fire fighting

After people have been brought to safety additional time must be calculated for the fire fighters to tackle the blaze. As a rule, 90 minutes following the outbreak of the fire should be sufficient to extinguish it. Power required by the electrical systems (e.g. water pumps, fire brigade lifts, mechanical smoke extraction systems) can be satisfied using class E90 cable systems.

Planning

Planning an electrical safety system means finding answers to the questions:

- Which parts of the building requires which level of safety?
- Which electrical system has to be supplied for how long?
- Which circuits are involved (safety circuits)?
- Which is the best cable routing for these circuits?
- Are there restrictions concerning fire load, etc.?

Only then the selection of appropriate cables and support systems can begin.

BETAflam® Approvals

Application

BETAfixss® supporting systems are applied for electrical cable installations with system circuit integrity in case of fire. Furthermore, they provide a fire proof fixing of the laid cables between storey ceiling and intermediate ceilings rated F30 or F90.

Note:
Specifications are valid
at time of printing.

BETAflam® Approval

MPA NRW Dortmund, Germany

Product group	Valid	Approval no.	Classification
BETAflam® NHXH E30 - E60	10 February 2020	P-MPA-E-05-008	E30, E60
BETAflam® NHXCH E30 - E60	10 February 2020	P-MPA-E-05-008	E30, E60
BETAflam® JE-H(St)H E30	10 February 2020	P-MPA-E-05-008	E30
BETAflam® JE-H(St)HRH E30	10 February 2020	P-MPA-E-05-008	E30
BETAflam® NHXH E90	10 February 2020	P-MPA-E-05-008	E90
BETAflam® NHXCH E90	10 February 2020	P-MPA-E-05-008	E90
BETAflam® JE-H(St)H E30 - E90	10 February 2020	P-MPA-E-05-008	E30, E60, E90
BETAflam® JE-H(St)HRH E30 - E90	10 February 2020	P-MPA-E-05-008	E30, E60, E90
BETAflam® JE-H(St)H E30 SIR	06 May 2017	P-MPA-E-12-008	E30, E60
BETAflam® JE-HH FE180/E30 SIR	09 September 2017	P-MPA-E-12-012	E30, E60
BETAflam® with clamp-mounting and junction box	10 March 2020	P-MPA-E-15-011	E30, E60, E90

BETAflam® Approval

VdS Schadenverhütung GmbH, Cologne, Germany

Product group	Valid	Approval no.	Classification
BETAflam® NHXH E90 ≥ 2.5 mm ²	21 July 2016	G 4980033	E90
BETAflam® NHXCH E90 ≥ 2.5 mm ²	21 July 2016	G 4980034	E90

BETAflam® Approval

with other producers of support systems

MPA NRW Dortmund, Germany

Anbieter	Valid	Approval no.	Classification
OBO Bettermann	31 December 2017	P-MPA-E-05-030	E30, E60, E90
PUK-Werke	31 December 2017	P-MPA-E-05-030	E30, E60, E90
PUK-Werke	10 August 2017	P-MPA-E-07-022	E30, E60, E90
RICO GmbH	31 December 2017	P-MPA-E-05-030	E30, E60, E90
NIEDAX GmbH & Co. KG	31 December 2017	P-MPA-E-05-030	E30, E60, E90
HILTI Germany GmbH	31 December 2017	P-MPA-E-05-030	E30, E60, E90

Approvals of other producers of support systems with BETAflam® Cables

Supplier	Approval	Classification
Spelsberg	Electrical distributors	E30, E60
Celsion, D-Rodgau	Electrical distributors	E30, E60
OBO Bettermann	Cable rack, mesh tray conduit in stainless steel	E30, E60, E90
OBO Bettermann	Cable trunk, junction boxes, clamps	E30, E60, E90

BETAflam® Approval on cable trays without threaded rods

Supplier	Approval	No.	Classification
LEONI Studer AG	Cable rack, cable ladder, multi tray, X span tray	P-MPA-E-05-008	E30, E60, E90
OBO Bettermann	Cable rack RKSM 610 ... 640	P-MPA-E-13-002	E30, E60, E90
PUK-Werke	Cable rack RG 60 – XX	P-MPA-E-07-022	E30, E60, E90
NIEDAX GmbH & Co. KG	Cable rack RLCV 60.100 – 400	P-MPA-E-11-007	E30, E60, E90
VergoKan	Cable rack KBSI	P-MPA-E-14-007	E30, E60, E90

Cables with integral system circuit integrity

We point out that system circuit integrity acc. to DIN 4102 part 12 is only attained if corresponding laying systems are used and if these are installed according to the effective DIN certificates or expertises respectively. The LEONI Studer products BETAflam® and BETAfixss® comply with this requirement for which reason we recommend their use.

Identification plate KZD

The finished cable system must be marked with an identification plate according to DIN 4102 part 12.



BETAfixSS® laying systems – overview

DIN 4102 part 12 (E30/E90)

3000 mm
Mounting distance

■ **WSB XL**
X span tray

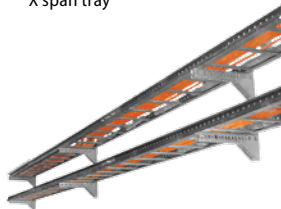

1500 mm
Mounting distance

■ **Upon request**
Cable rack



■ **Upon request**
Cable ladder



■ **GK**
Mesh tray

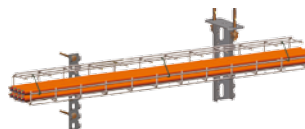

■ **STR**
Vertical riser

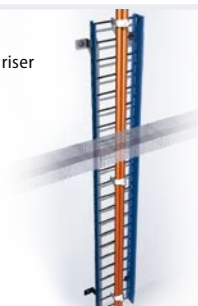

1200 mm
Mounting distance

■ **ES, GSM**
Single clamp and joint clamp



■ **RES**
Tube laying



■ **BAC**
U-clamp with system track

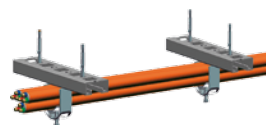

■ **RBS**
Tube and clamp with system track

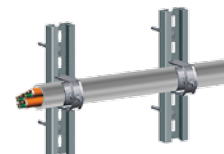

800 mm
Mounting distance

■ **ES, GSM**
Single clamp and joint clamp



■ **BAC**
U-Clamp with system track

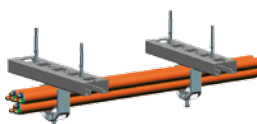

■ **DWS**
Ceiling / wall hanger

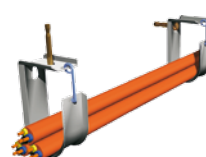

■ **Insta-Clic**
Cable holder and conduit 2-in-1



600 mm
Mounting distance

■ **F**
Single clamp

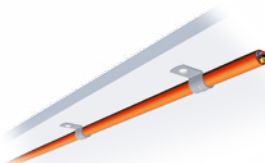

■ **RF**
Plastic tube with single clamp



Accessories

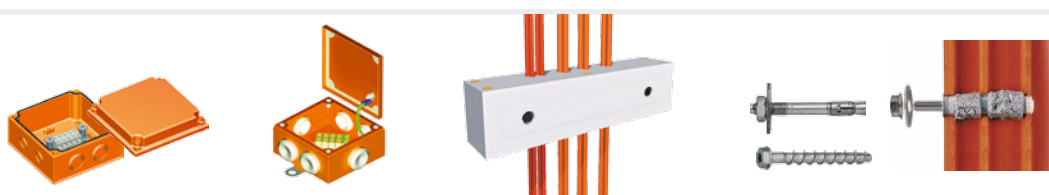

Further products

BETAtherm®

- Premium, halogen-free and electron-beam cross-linked lead wires
- Temperature resistant, increased dielectric strength, easy stripping

BETAflam® flex

- Premium flexible connection and power cables
- Good resistance to aggressive media, halogen-free and flame retardant

BETAflam® CHEMAflex®

- Oil and chemical resistant connection and power cables
- Temperature resistant, halogen-free, flame retardant, easy stripping

BETAtrans®

- Premium flexible halogen-free connection and power cables
- Excellent mechanical and dielectric strength

BETAflam® Solar

- Double insulated lead wires
- Electron-beam cross-linked and halogen-free
- For solar power applications

BETAjet®

- 400 Hz ground power cable systems
- For mobile and static applications

BETAlux®

- Media resistance 5 kV-primary cables
- Feeder cables for airfield lighting

BETAflam®

- Fire resistant safety cables for highest demand
- Flame retardant, low smoke density, no flame propagation

BETAfixss®

- Laying systems with circuit integrity under fire

BETApower

- Medium voltage power cables TRI-DELTA® and Fireprotec
- Low voltage power cables GKN and GN-CLN
- Flexible single-core cable BETAflam® TRAF0-FLEX
- Accessories for cables

BETAsolution®

- The solution for cable system engineering
- Power and communication transmission – all from one source

MegaLine®

- Quality solutions for the passive copper cabling infrastructure in data, patch and trunk cables
- Innovative MegaLine® Connect connection technology

GigaLine®

- Fiber optic data, patch and trunk cables for extremely high bandwidth and longer transmission distances
- Perfectly matched GigaLine® connection technology – powerful tools for building a fiber optic infrastructure

VarioLine®

- Modular system with peripheral collector and underfloor programs
- For simple and fast integration in different applications

Find out more:

Business Unit Energy & Infrastructure

energy-infrastructure@leoni.com

www.leoni-energy-infrastructure.com

LEONI Studer AG

Herrenmattstrasse 20

4658 Daeniken

Switzerland

Phone +41 (0)62 288 82 82

Fax +41 (0)62 288 83 83

LEONI Kerpen GmbH

Zweifaller Strasse 275–287

52224 Stolberg

Germany

Phone +49 (0)2402 17 1

Fax +49 (0)2402 75154