

Plexo switches and two-ways

Cat. No(s): 695 11/12/13/15/16/19/21/25/26/30/31/32/38
696 11/12/13/15/19/25/26/27/29
697 09/11/12/13/14/15/16/18/51/52/53/54/55/56/58
698 11/12/17/51/52/55/56

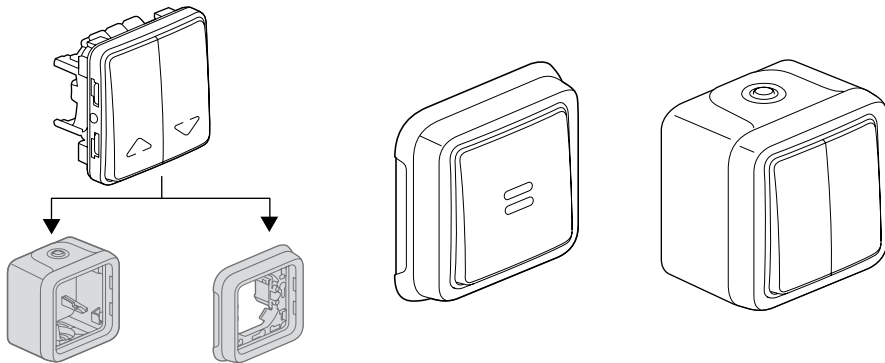

CONTENTS	Page
1. Technical data	1
2. Range	1
3. Preparation	1-2
4. Overall dimensions	3
5. General characteristics	3-4
6. Cleaning	4
7. Label holder	4
8. Double illuminated products	4
9. Equipment and accessories	4
10. Conformities and approvals	5

1. TECHNICAL DATA

Weatherproof wiring devices system intended for residential and professional technical premises (garages, cellars, car parks, workshops and industrial kitchens, etc.) as well as outdoor environments (patios, terraces, gardens, camping sites, etc.).
10 AX - 250 V~ lighting control mechanisms with or without indicating (lights) or signalling (marking) components.
All illuminated or pilot light products are supplied with their lamps fitted.
6 AX - 250 V~ for Cat. Nos 695 15 and 696 15.

2. RANGE

Cat. No.	2 versions: grey and white
695 xx 696 xx	Configurable
697 xx 698 xx	Surface-mounting complete Flush-mounting complete

Designation	Marketing Cat. Nos	Characteristics	Connection
CONFIGURABLE	695 11/12/13/16/19/21/25 695 26/30/31/32/38 696 11/12/13/19 696 25/26/27/29	10 AX - 250 V~	Auto terminals
	695 15 - 696 15	6 AX - 250 V~	Auto terminals
COMPLETE	697 09/11/12/13/14/15/16/18 697 51/52/53/54/55/56/58	10 AX - 250 V~	Auto terminals
	698 11/12/17 698 51/52/55/56	10 AX - 250 V~	Auto terminals

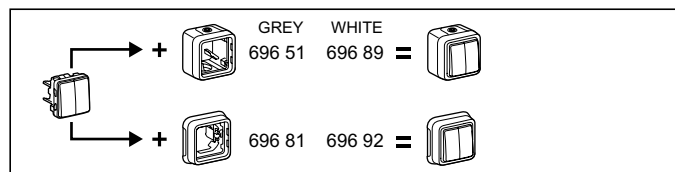

3. PREPARATION

3.1 Surface-mounting

- By screwing the base box onto the support using 2 screws Ø 3-4 mm max.
- To replace the former Plexo 55 series

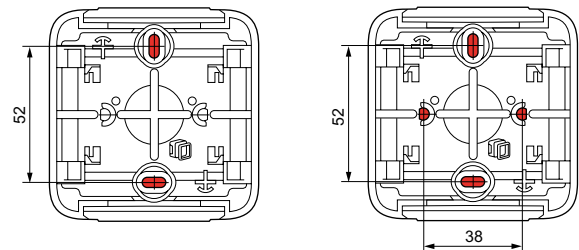

3.2 Flush-mounting

- frame dismantling

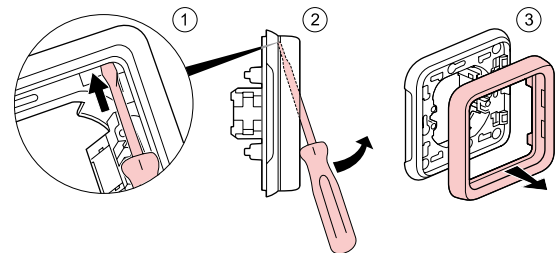

- by screwing onto a flush-mounting box
- by claws onto a flush-mounting box cat. No. 699 XX

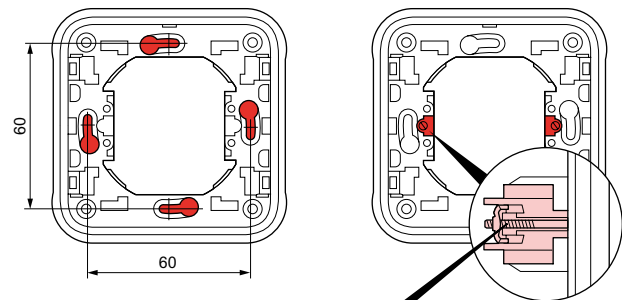

Possibility to place claws:
Cat. No. 849 00 or
Cat. No. 849 01 (long claw)

Plexo switches and two-ways

Cat. No(s): 695 11/12/13/15/16/19/21/25/26/30/31/32/38
 696 11/12/13/15/19/25/26/27/29
 697 09/11/12/13/14/15/16/18/51/52/53/54/55/56/58
 698 11/12/17/51/52/55/56

3. PREPARATION (continued)

- By face plate using 4 screws Ø 4 mm
- Piercing of support material for diameter 60-70 mm using cylinder saw or punch.

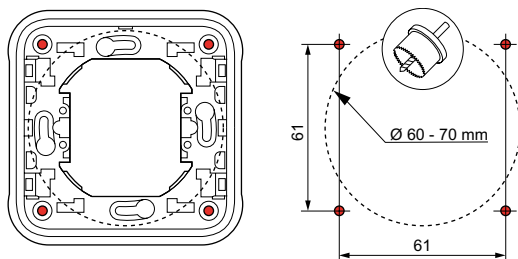

3.3 Connection to conductors

- Automatic terminal mechanisms

• 1 break

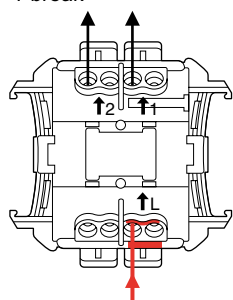

• 2 breaks

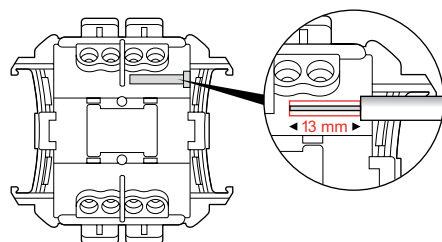
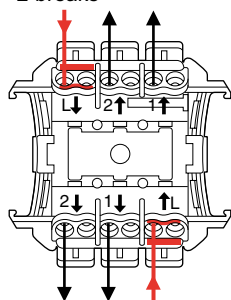

The stripping length required is 13 mm. The correct stripping length can be checked against the gauge on the rear of the base. Terminal capacity is 1.5 mm² - 2.5 mm² (1 or 2 conductors).

3.4 Connection to conduits

Type of conduits:

- IRL: formerly IRO, insulating rigid smooth
 - ICA: insulating bendable corrugated
 - ICTA: insulating, bendable, transversally elastic, corrugated.
 - ICTL: insulating, bendable, transversally elastic, smooth.
- Ø 16 - 25 mm

Cables (examples):

- rigid conductors: U - 1000R2V 3G2.5
- flexible conductors: H07 RN - F 3G2.5

Type of outlet glands: membrane flexible, 2 removable types.

- 1-outlet gland supplied on 1-gang box (top and bottom)
- 1-outlet gland supplied on 2 and 3-gang boxes (top)
- 2-outlet gland supplied on 2 and 3-gang boxes (bottom)

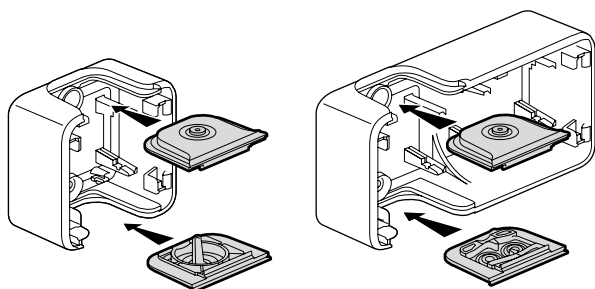

3. PREPARATION (continued)

3.4 Connection to conduits (continued)

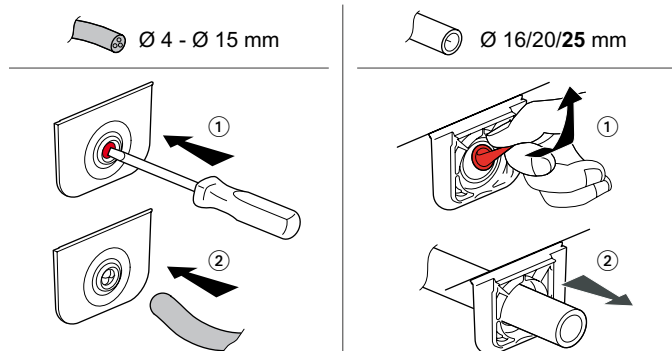

Also available as accessories:

- 695 96 1-outlet gland grey
- 695 99 2-outlet gland grey
- 696 46 1-outlet gland white
- 696 49 2-outlet gland white

3.5 Assembly

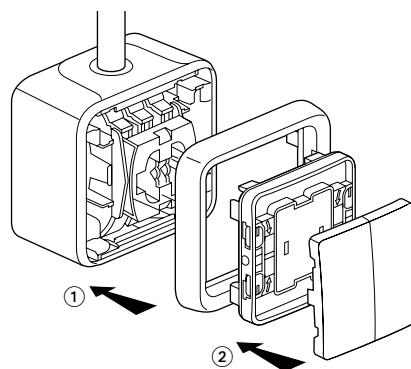

The front part (cover) is IP55 locked onto the box using four 1/4 turn screws.

The direction of rotation of each 1/4 turn screw is marked on the cover.

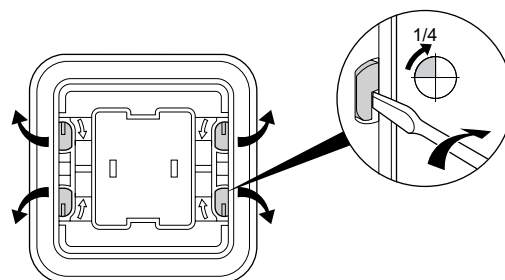

Plexo switches and two-ways

Cat. No(s): 695 11/12/13/15/16/19/21/25/26/30/31/32/38
 696 11/12/13/15/19/25/26/27/29
 697 09/11/12/13/14/15/16/18/51/52/53/54/55/56/58
 698 11/12/17/51/52/55/56

4. OVERALL DIMENSIONS

Configurable

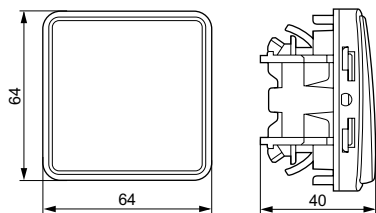

Surface-mounting

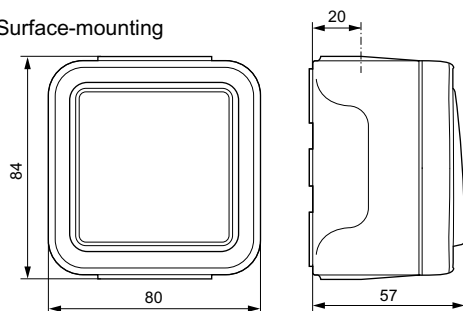

Flush-mounting

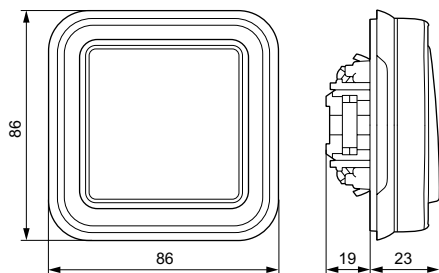

5. GENERAL CHARACTERISTICS

5.1 Mechanical characteristics

Protection index:
 - IP 55 IK 07

5.2 Material characteristics

Materials

Box, support: PP (reinforced polypropylene)
 Front plate, rocker: ABS (acrylonitrile butadiene styrene)
 Entry gland, cover plate: PP+SEBS (styrene ethylene butadiene styrene)
 Mechanism: PC (polycarbonate)

5.3 Resistance to chemicals

Chemical	Behaviour
Acetone	-
Acetic acid 10 %	+
Acetic acid ≥ 30 %	+
Aminosulphonic acid	-
Boric acid*	+
Bromhydric acid 47 %	-
Hydrochloric acid*	-
Chromic acid	+
Citric acid*	+
Hydrofluoric acid*	-
Formic acid	-
Lactic acid*	+
Linoleic acid	-
Maleic acid	+
Nitric acid 30 %	-
Nitric acid 50 %	-
Perchloric acid 10 %	+

Phenol-sulphonic acid	-
Phosphoric acid*	-
Sulphuric acid	+
Tannic acid*	-
Tartaric acid*	+
Ethyl alcohol	+
Isopropyl alcohol	+
Methanol	-
Phenylethyl alcohol 100 %	-
Amonia	+
Electroplating baths:	
- Bright silver bath	+
- Bright cadmium bath	+
- Chrome bath (50° C)	+
- Copper bath (with potassium cyanide)	+
- Copper bath (acid)	+
- Pickling bath with chemical copper	+
- Brass bath	+
- Bright nickel bath	+
Barium	
- Barium chloride*	+
- Barium hydroxide*	+
- Barium nitrate*	-
Benzene	-
Beer	+
Bleaching powder*	+
Cobalt chloride*	-
Copper chloride*	-
Ferrous chloride*	-
Manganese chloride	-
Mercury chloride*	-
Methylene chloride	-
Chlorine water (wet gaseous chlorine)	-
Sea water	+
Fertilizer	+
Epichlorhydrine	-
Heavy gasoline	-
White gasoline	-
Turpentine	-
Essential oils	+
Linseed oil	+
Lubricating oil	+
Machinery oil	+
Mineral oil	+
Paraffin oil	+
Fish oil	+
Castor oil	+
Silicon oil	+
Humus	+
Aqueous hydrogen sulphide	+
Sodium hypochlorite 10 %	+
Fruit juice	+
Milk	+
Chlorinated detergent	+
Margarine	+
Black oil	+
Mercury	+
Methyl methacrylate	-
Silver nitrate*	+
Cobalt nitrate*	+
Manganese nitrate*	+
Mercury nitrate*	+
Nickel nitrate*	+
Lead nitrate*	+
Petroleum, petroleum ether	-
Silicate (Potassium, Sodium)	+
Beet syrup	+
Sodium	
- Sodium acetate*	+
- Sodium bromate*	+
- Sodium chloride* (salt)	+

Plexo switches and two-ways

Cat. No(s): 695 11/12/13/15/16/19/21/25/26/30/31/32/38
 696 11/12/13/15/19/25/26/27/29
 697 09/11/12/13/14/15/16/18/51/52/53/54/55/56/58
 698 11/12/17/51/52/55/56

5. GENERAL CHARACTERISTICS *(continued)*

5.3 Resistance to chemicals *(continued)*

Caustic soda $\leq 40\%$	+
Styrene monomer	-
Sugar	+
Trichloroethylene	-
Urine	+
Wine	+

*All concentrations in aqueous solution.

Interpretation: + resists - instability

This information is given for guidance, and does not therefore engage our liability. Consult us for any special use.

5.4 UV resistance

No noticeable change following a 7-day test with irradiance of 550 W/m² (colorimetric measurement according to Lab method)

5.5 Resistance to salt spray: 7 days (168 h)

5.6 Electrical characteristics

- Self-extinguishing to CEI 60695-2-11:
 components (or parts) required to hold live parts in place : 850°C
 components (or parts) not required to hold live parts in place : 650°C
- Voltage - Current - Frequency
 10 AX - 250 V~ - 50 Hz suivant NF EN 60669-1, NBN EN 60669-1 et CEI 60669-1

5.7 Climatic characteristics

Storage and use temperature: - 25°C to + 60°C

6. CLEANING

Surface cleaning with dry cloth or cloth dipped in soapy water. Do not use acetone, tar remover or trichloroethylene.

Important: a test should be carried out before using any specific cleaners.

7. LABEL HOLDER

695 16/43/44 - 696 33/34
 698 24/25/64/65

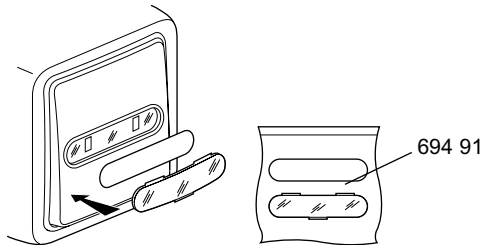





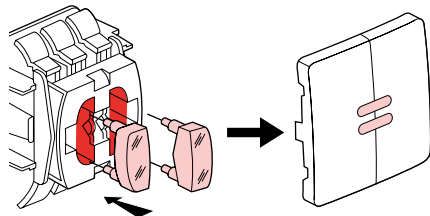









8. DOUBLE ILLUMINATED PRODUCTS

695 19/26 - 696 19/26



9. EQUIPMENT AND ACCESSORIES



Description	Uses	Cat. No.	Colour
Label holder + label 	PVC label 30/100 th for label-holder products	694 91	
Lamp 230 V 0.5 mA fluorescent green 	Only for illuminated and basic push-button	694 96	
Lamp 230 V 0.5 mA verte fluorescente 	Indicator light	694 97	
Lamp 230 V 1 mA neon orange 	Pilot light	694 98	
Lampe 12 V 15 mA fluorescent green 	Indicator light	694 99	
Lamp 12 V 20 mA fluorescent green 	Indicator light	694 95	
1-outlet gland 	For making an aesthetic junction between boxes and cables up to Ø 16 mm inclusive	695 96 696 46	Grey White
2-outlet gland 		695 99 696 49	Grey White
Plotting template 	For rapidly finding the fixing distances of all the boxes	695 97	
Set of 4 caps 	For blanking the fixing holes at the box base	695 98	Grey
Multi-cable gland 	(PG) Ø 7 - 14 mm	696 53	
Standard claw 	Mounts on all flush-mounting 1-gang supports by simple clipping	849 00	
Long claw 		849 01	
Claw 	To increase IK 07 to IK 08 for sockets and switches flush mounting items	696 47	
Tapping terminal strip 	Direct connection after simple stripping of rigid conductors Terminal capacity: 0.75 to 2.5 mm ²	343 22	

Plexo switches and two-ways

Cat. No(s): 695 11/12/13/15/16/19/21/25/26/30/31/32/38
696 11/12/13/15/19/25/26/27/29
697 09/11/12/13/14/15/16/18/51/52/53/54/55/56/58
698 11/12/17/51/52/55/56

10. CONFORMITIES AND APPROVALS

- Products produced in compliance with standards:
 - France NF EN 60669-1
 - Belgium NBN EN 60669-1
 - International IEC 60669-1
- NF USE approval according to NF EN 60669-1

Quality marks	Standards	Cartificate N°
	NF EN 60669-1	27/11/2007
	EN 60669-1	31/05/2007