

# Plexo / Mosaic™ adaptors

Cat. No(s) : 695 79/80/82

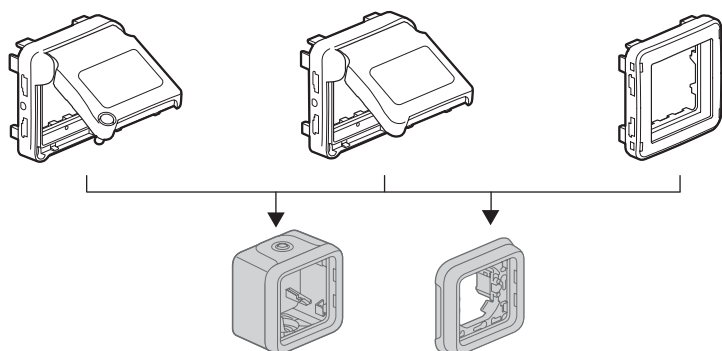

CONTENTS	Page
1. Technical characteristics	1
2. Range	1
3. Mosaic™ mechanisms	1
4. Installation	5
5. Dimensions	6
6. General characteristics	7
7. Maintenance	8
8. Lid protection	8
9. Specific uses	8
10. Equipment and accessories	8

## 1. TECHNICAL CHARACTERISTICS

Weatherproof wiring device system designed for residential and professional technical locations (garages, cellars, car parks, workshops and industrial kitchens, etc) as well as for outdoor applications (patios, gardens, camp sites, etc).

These three adaptors with or without lid (IP 20 or IP 55) give access to more than 90 different mechanisms in the Mosaic™ programme, while maintaining the characteristics of the Plexo range. They can be flush or surface mounted on all one-gang, multi-gang and cable gland boxes in the Plexo range.

## 2. RANGE

	Commercial Cat. No.	Description	IP	Weight
Composable	695 79	Adaptor with opaque lid lockable with special tool Cat. No. 91945(grey/white)	55	40 g
	695 80	Adaptor with opaque lid (grey/white)	55	36 g
	695 82	Adaptor without lid (grey/white)	20	22 g

	Grey	White	=	
	696 51	696 89		
	Grey	White	=	
	696 81	696 92		

## 3. MOSAIC™ MECHANISMS

### 3.1 Adaptor without lid 695 82

All 2 module Mosaic™ mechanisms are compatible with the adaptor without lid Cat. No. 695 82.

### 3.2 Adaptor with lid 695 79/80

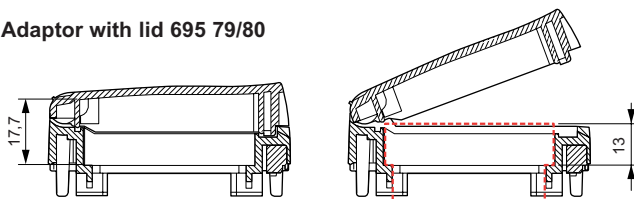

Only compatible with Mosaic™ products with front, and not rear, mounted centre plate.

Compatible with all mechanisms where the height under the lid is 17.7 mm on the hinge side and 13 mm on the lid opening side.

Products which are not compatible are shown with \* or \*\* (pages 2 and 4).

## 3. MOSAIC™ MECHANISMS (cont.)

### 3.3 Compatible Mosaic mechanisms

#### Switches 10 AX - 250 V~

##### White centre plate

- 770 11 2-way switch 10 AX
- 770 12 2-way switch 10 AX with LED indicator<sup>(1)</sup>
- 770 21 Intermediate switch 10 AX

##### Aluminium centre plate

- 792 11 2-way switch 10 AX
- 792 12 2-way switch 10 AX with LED indicator<sup>(1)</sup>

#### Switches 20 AX - 250 V~

- 770 50 Double pole switch 20 AX
- 770 52 Double pole switch 20 AX with LED indicator<sup>(2)</sup>

#### Push-buttons 6 A - 250 V~

Fast connection with automatic terminal blocks - no tool required

##### White centre plate

- 770 40 Push-button 6 A
- 770 41 Changeover push-button 6 A
- 770 42 Changeover push-button 6 A with LED indicator<sup>(1)</sup>
- 770 43 Changeover push-button 6 A with label holder

##### Aluminium centre plate

- 792 40 Push-button 6 A
- 792 42 Changeover push-button 6 A with LED indicator<sup>(1)</sup>

<sup>(1)</sup> For the indicator function, use indicator LEDs Cat. No. 676 68  
For the lighting function, use lighting LED Cat. No. 676 66 for 230 V and 676 67 for 12, 24 and 48 V.

<sup>(2)</sup> For indicator or lighting functions, use Cat. No. 676 64.

## 3. MOSAIC™ MECHANISMS (cont.)

### 3.3 Compatible Mosaic mechanisms (cont.)

#### Motion-sensitive switch 10 AX

766 66



Used to control light sources, simply by a hand movement near the switch. Particularly suitable for applications in medical environments

#### Dimmers 110-250 V~ - 50 Hz

With on/off buttons and an independent +/- dimmer button.

Can be controlled remotely by parallel wired push-buttons or used in a 2-way arrangement in connection with a switch.

Previously set lighting level will be restored.

Fit into box depth 40 mm min.

#### Without neutral, 2 wires, 400 W

Used to control lamps :

- up to 400 W for incandescent or 230 V~ for halogen
- up to 400 VA, halogen lamps with ferromagnetic or electronic transformer.

784 01



White centre plate

792 04



Aluminium centre plate

#### Dimmer 0-10 V

784 04



With on/off buttons and an independent +/- dimmer button.

Used to switch on, off and dim fluorescent tubes with electronic ballast 0-10 V  
 Max control current : 40 mA  
 Max power : 600 VA  
 Fit into box depth 50 mm recommended.

#### Programmable time switch

With 20 hour working reserve  
 Capacity : 8 weekly programmes  
 Temporary or permanent override  
 1 outlet - 16 A - 250 V~ cos φ = 1  
 1 changeover contact

784 25



Used to program a circuit with loads :  
 - 1200 W incandescent and 230 V~ halogen  
 - 1800 VA fluorescent Ø26 or 38 mm and halogen lamps with ferromagnetic or electronic transformer  
 - 1800 W motors (ventilation only)  
 - 3600 W resistive (heating only).

#### Controlled mechanical ventilation control

770 27



Fast connection with automatic terminal blocks - no tool required  
 2-way switch for direct control of controlled mechanical ventilation 10 AX - 250 V~

#### Single-pole relay

766 90



Used to relay low power cut-off functions near to the application  
 Resistive : 3000 W, Incandescent : 1800 W  
 Halogen : 1800 W, Fluorescent : 400 VA  
 Motors (electric shutter type) : 530 W

## 3. MOSAIC™ MECHANISMS (cont.)

### 3.3 Compatible Mosaic mechanisms (cont.)

#### Key operated switches for Self-contained emergency lighting units

766 30



Used to increase number of control points  
 Must be used in conjunction with Cat. No. 039 00  
 Simultaneously cuts off lighting circuits and resets emergency lighting units to stand-by.

#### Key operated switch

##### 2-position switch - European barrel

770 74\*\*



2 NO contacts 6 A - 250 V~  
 Key can be removed in both positions  
 To be fitted with standard European barrel or barrel  
 Cat. No. 697 95

##### 3-position push-button - European barrel

770 75\*\*



Inverter with off position 6 A - 250 V~  
 To be fitted with standard European barrel or barrel  
 Cat. No. 697 95

#### Switches for electric shutters

For direct control (raise/lower/stop) of shutter, blind or awning motor 500 W max

770 26



Switch white centre plate

792 26



Switch aluminium centre plate

#### Push-buttons for electric shutters

For direct or automatic control of shutter, blind or awning motor 500 W max

770 25



Push-button white centre plate

792 25



Push-button aluminium centre plate

#### PLC control for electric shutters and blinds

Used to control zones of shutters individually or centrally (raise/lower/stop)  
 For all types of shutter motor with mechanical or electronic stop  
 Mains connection 230 V~  
 Operation by PLC and infrared  
 Fit into box depth 40 mm  
 White centre plate

#### Individual control

770 23



Direct control of a shutter motor 500 W max (raise/lower/stop)  
 Can be controlled remotely from the same room or another room by up to 16 centralised switches  
 Cat. No. 770 24

#### Centralised control

770 24



Used to control (raise/lower/stop) a zone containing as many individual switches Cat. No. 770 23 as required  
 Fitted with two raise and lower auxiliary inputs for control by dry contact from a time switch, dusk-to-dawn switch, etc.

\*\* For flush mounting assembly only, depth: 50 mm  
 With adaptor without lid.













## 3. MOSAIC™ MECHANISMS (cont.)

### 3.3 Compatible Mosaic mechanisms (cont.)

#### Single multi-support socket outlets

For fitting in flush mounting box, surface mounting surround, floor unit, column outlet unit, feed unit, office outlet unit

Connection with automatic terminal blocks (except where stated otherwise).



771 11		2P+E straight
771 13		2P+E straight with special tap connection and 4 mm <sup>2</sup> , screw terminals
771 45		2P+E angled at 45°
792 71		2P+E straight aluminium centre plate
771 14		2P+E straight foolproof, screw terminals
771 10		2P
771 32		Socket outlet with flush holes to facilitate cleaning and avoid dirt accumulation
771 12		2P+E with indicator <sup>(1)</sup>
771 15		2P+E foolproof with indicator <sup>(1)</sup> , screw terminals
771 16		2P+E green
771 17		2P+E orange
771 18		2P+E red

<sup>(1)</sup>Indicator Cat. No. 676 64 supplied with product

#### International standard socket outlets

##### German

Mainly used in: Germany, Spain, Greece, Portugal, etc.

772 13		2P+E with special 4 mm <sup>2</sup> screw terminals and tap connection
772 14		2P+E with special 4 mm <sup>2</sup> screw terminals and tap connection

##### Euro-US

775 02		2P+E
--------	-------------------------------------------------------------------------------------	------

##### US

775 04		2P+E 15 A
--------	-------------------------------------------------------------------------------------	-----------

##### British

775 05		2P+E 13 A
--------	-------------------------------------------------------------------------------------	-----------

##### Italian

775 12		2P+E 16 A P30
--------	-------------------------------------------------------------------------------------	---------------

##### Swiss

775 06		2P+E type 13
--------	-------------------------------------------------------------------------------------	--------------

## 3. MOSAIC™ MECHANISMS (cont.)

### 3.3 Compatible Mosaic mechanisms (cont.)

#### Telephone sockets



##### 8 contact socket

787 38		Takes test module (RC) Cat. No. 512 48
--------	-----------------------------------------------------------------------------------	----------------------------------------

##### RJ 11 and RJ 12 sockets

Fitted with a modular jack connector with 1/4 turn terminal block for fast connection.

Tap connection possible

787 31		RJ 11, 4 contacts
787 32		RJ 12, 6 contacts

##### ISDN socket

Self-stripping 1/4 turn terminals for fast connection  
Tap connection possible.

787 34		8 contacts, earth terminal 2.5 mm <sup>2</sup>
--------	-----------------------------------------------------------------------------------	------------------------------------------------



##### RJ 45 10<sup>GIGA</sup> sockets

For LCS 10<sup>GIGA</sup> Legrand cabling system



786 41		STP/FTP - 9 contacts, shielded folded metal
--------	-----------------------------------------------------------------------------------	---------------------------------------------

##### RJ 45 Cat. 6 sockets



###### Cat. 6 STP

786 31		STP - 9 contacts, shielded metal cover
786 33		STP - 9 contacts, shielded Zamak
786 32		STP - 9 contacts, shielded folded metal, socket at 90°

###### Cat. 6 FTP

786 91		FTP - 9 contacts
792 91		FTP - 9 contacts, aluminium finish
786 92		FTP - 9 contacts, socket at 90°

###### Cat. 6 UTP

786 61		UTP - 8 contacts
792 61		UTP - 8 contacts, aluminium finish
786 62		UTP - 8 contacts, socket at 90°

##### RJ 45 Cat. 5e sockets

###### Cat. 5e FTP

786 81		FTP - 9 contacts
--------	-------------------------------------------------------------------------------------	------------------



###### Cat. 5e UTP

786 51		UTP - 8 contacts, 2 modules
--------	-------------------------------------------------------------------------------------	-----------------------------

## 3. MOSAIC™ MECHANISMS (cont.)

### 3.3 Compatible Mosaic mechanisms (cont.)

#### Television and satellite sockets

- 787 82  TV socket dia 9.52 mm male 0 - 2400 MHz
- 787 80  TV socket type "F" screw-in 0 - 2400 MHz
- 787 86  TV/FM/SAT socket

#### Video sockets

Connection by 1 mm<sup>2</sup> cross-section screw terminal block

#### HD15 female

- 787 57  Used to connect VGA, XGA or VESA, PC monitor, plasma screen, video projector, graphics pad, etc.

#### HD15 adaptor + 5 BNC pre-connected

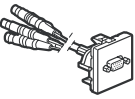
- 787 59  VGA adaptor, HD15 female base to 5 BNC female 75 Ω sockets  
Recommended cable : coaxial KX6  
Max cable length : 25 m (VGA amplifier recommended for longer lengths)

#### Audio sockets

##### Loudspeakers

- 787 51  2 module speaker socket - 4 mm<sup>2</sup> terminal block

##### XLR 3 pole

Used for stereo connections of any peripherals, microphone, amplifier, mixing desk, etc.



- 787 65  Female Neutrik

- 787 56  Male Neutrik

##### Speakon 4 contacts

- 787 60  Used to connect power speakers  
Recommended cable : audio single pair 2.5 mm<sup>2</sup>  
Max cable length : 50 m (audio amplifier recommended for longer lengths).

##### SUB D socket

- 787 65  9 contacts with screw connector for RS 232 type serial connection
- 787 67  9 contacts with solder connector for RS 232 type serial connection
- 787 66  15 contacts with solder connector, e.g. for special X21 type line between two remote units.

#### Fibre optic equipment

Fitted with 2 input / 2 output duplex feedthroughs

##### Fibre optic feedthrough socket 2 x ST

- 786 16\*  Bayonet connection (STII compatible)

##### Fibre optic feedthrough socket 2 x SC

- 786 17\*  "Push-pull" connection

##### Fibre optic feedthrough socket 2 x LC

- 786 18\*  "Push-pull" connection

\* For assembly with adaptor without lid only



## 3. MOSAIC™ MECHANISMS (cont.)

### 3.3 Compatible Mosaic mechanisms (cont.)

#### Proximity MCB



Locally protects part of a circuit against overloads and short-circuits  
Breaking capacity : 3000 A - NF C 61-410 (10/16 A) 1500 A - NF C 61-410 (6 A).

#### MCB Single pole + Neutral 230 V~









- 775 21  10 A
- 775 22  16 A

#### RCBO Single pole + Neutral 230 V~

The residual current device provides additional protection for people (rooms with conducting floors, presence of water, etc) against direct contact with live parts or earth leakages.  
Nominal earth leakage current : 30 mA

- 775 31  10 A
- 775 32  16 A



#### Copper feedthroughs

- 786 23\*  **Cat. 6 FTP**  
FTP - 9 contacts
- 786 27\*  FTP - 9 contacts, aluminium finish
- 786 22\*  **Cat. 6 UTP**  
UTP - 8 contacts
- 786 26\*  UTP - 8 contacts, aluminium finish
- 786 21\*  **Cat. 5e FTP**  
FTP - 9 contacts
- 786 25\*  FTP - 9 contacts, aluminium finish
- 786 20\*  **Cat. 5e UTP**  
UTP - 8 contacts
- 786 24\*  UTP - 8 contacts, aluminium finish

#### Class A buzzer

- 415 07  Complies with standard EN 54-3 certified NF  
Possibility of continuous or AGS sound  
12 - 48 V supply = +/- 10%  
Sound power at 2 m : 70 dB  
Average power consumption : 12 V = 5 mA,  
24 V = 9 mA, 48 V = 17 mA

#### Bells and sounders

- 766 40  8 V~ - 50/60 Hz  
Power consumption : 370 mA  
Sound level : 70 dB at 1 m
- 766 41  230 V~ - 50/60 Hz  
Power consumption : 25 mA  
Sound level : 70 dB at 1 m
- 766 42  Bell with electronic tone  
12-24-48 V DC  
Power consumption : 5-9-17 mA  
Depending on power supply  
Sound level : 80 dB at 1 m

\* For assembly with adaptor without lid only

## 4. INSTALLATION

### 4.1 Surface mounting

- by screwing back box onto support using two  $\varnothing 3$  mm -  $\varnothing 4$  mm max. screws

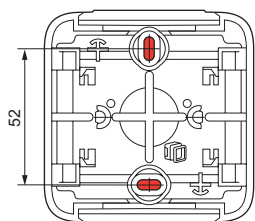

- Replaces former Plexo 55 series

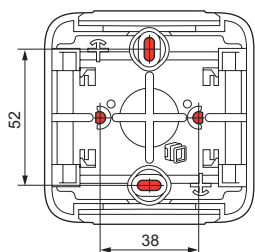

### 4.2 Flush mounting

- with screws on flush box

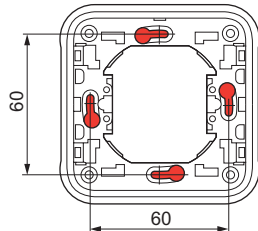

- with claws on flush box

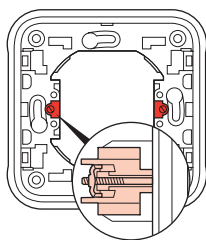

Claws can be added : Cat. No. 849 00 or  
Cat. No. 849 01 (long claws)

## 4. INSTALLATION (cont.)

### 4.2 Flush mounting (cont.)

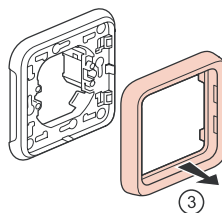
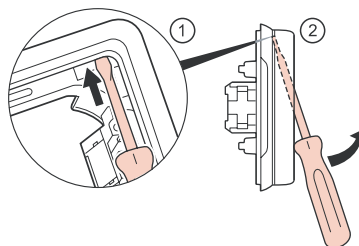

- On solid faceplate (without accessories) using 4 x  $\varnothing 4$  mm screws on metal or plastic cabinets.  
Drill support material (diameter 60 - 70 mm) using circular saw or hole punch.

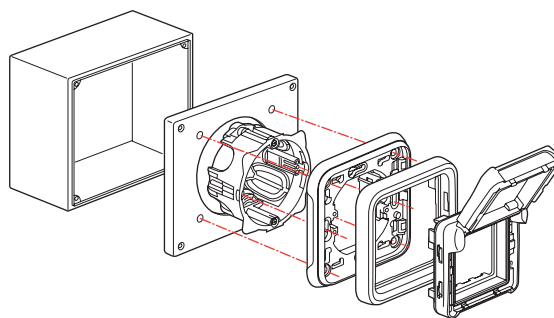
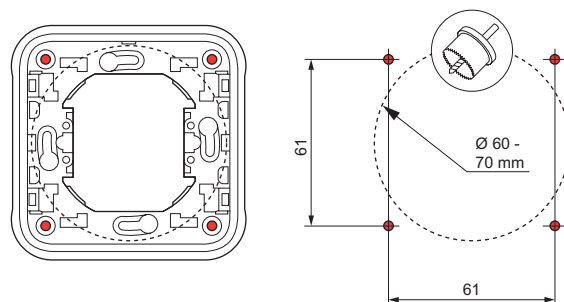

## 4. INSTALLATION (cont.)

### 4.3 Conduit connection

Type of conduit :

- IRL : formerly IRO, insulating rigid smooth tube
  - ICA : insulating flexible bendable corrugated tube
  - ICTA : insulating flexible transversally bendable elastic corrugated conduit
  - ICTL : insulating flexible transversally bendable elastic smooth conduit
- } Ø16 - 25 mm

Cables (examples) :

- rigid conductors : U - 1000R2V 3G2.5
- flexible conductors : H07 RN - F 3G2.5

- Type of entry gland : flexible with membrane, 2 removable types.
- entry gland with 1 entry supplied with 1-gang box (top and bottom)
  - entry gland with 1 entry supplied with 2-gang and 3-gang boxes (top)
  - entry gland with 2 entries supplied with 2-gang and 3-gang boxes (bottom)

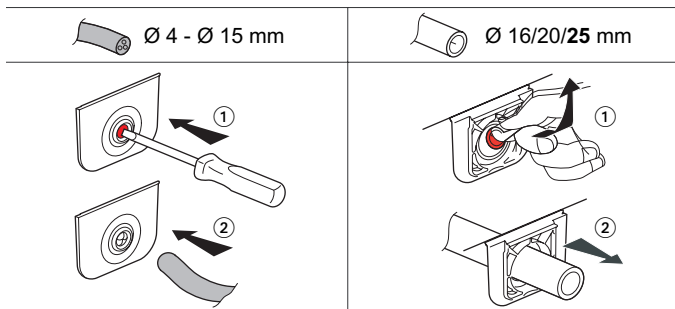
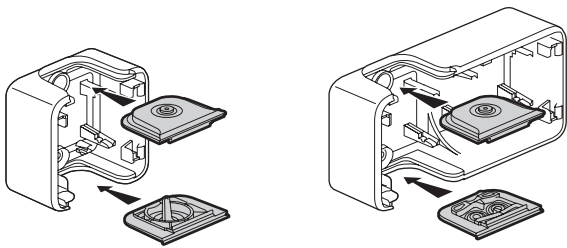

Also available as accessories :

- 695 96 grey entry gland 1 entry
- 695 99 grey entry gland 2 entries
- 696 46 white entry gland 1 entry
- 696 49 white entry gland 2 entries

IP55 sealing of the front part (cover) on the box is ensured by rotating four 1/4 turn fixings.

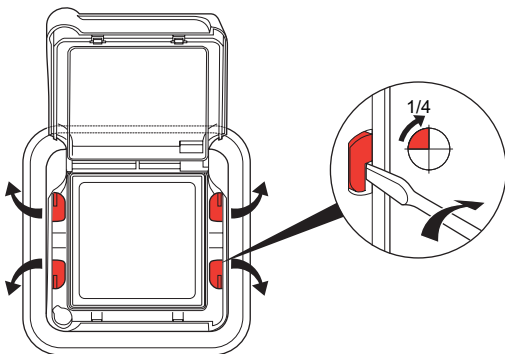

## 5. DIMENSIONS

Composable

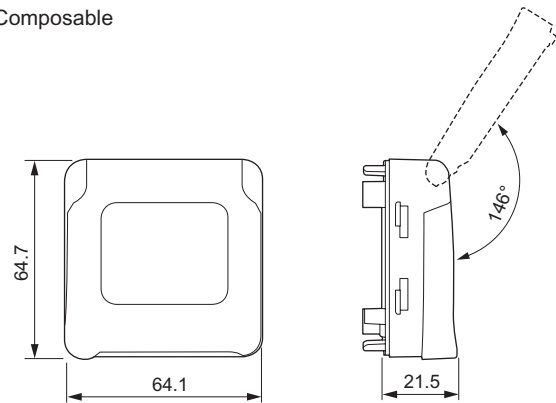

Surface mounting

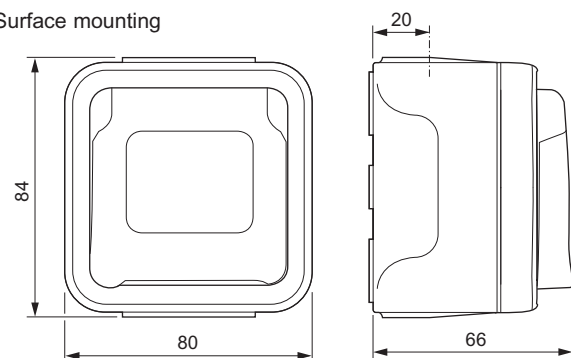

Flush mounting

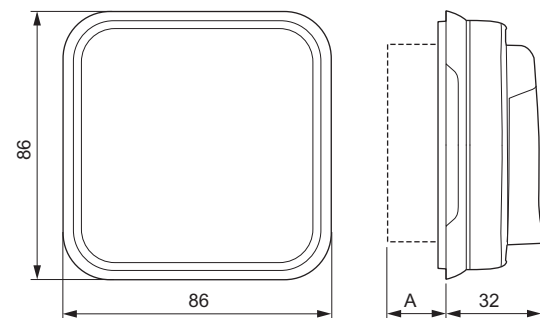

A : Variable depending on depth of Mosaic™ product



**6. GENERAL CHARACTERISTICS**

**6.1 Mechanical characteristics**

Protection rating :

- IP 55 IK 07 695 79/80

- IP 20 695 82

**6.2 Material characteristics**

**Materials**

Box, support : PP (filled Polypropylene)

Plate : ABS (Acrylonitrile-Butadiene-Styrene)

Entry gland, centre plate : PP + SEBS (Styrene-Ethylene-Butadiene-Styrene)

Transparent lid : PC (Polycarbonate)

**6.3 Resistance to chemicals**

	Behaviour
Acetone	-
Acetic acid 10 %	+
Acetic acid 30 %	+
Aminosulphonic acid	-
Boric acid *	+
Hydrobromic acid 47 %	-
Hydrochloric acid *	-
Chromic acid	+
Citric acid *	+
Hydrofluoric acid *	-
Formic acid	-
Lactic acid *	+
Linoleic acid	-
Maleic acid	+
Nitric acid 30 %	-
Nitric acid 50 %	-
Perchloric acid 10 %	+
Benzenesulphonic acid	-
Phosphoric acid *	-
Sulphuric acid	+
Tannic acid *	-
Tartaric acid *	+
Ethanol	+
Isopropyl alcohol	+
Methyl alcohol (methanol)	-
Phenylethylalcohol 100 %	-
Ammonia	+
Baths for electroplating :	
- Bright silver bath	+
- Bright cadmium bath	+
- Chromium plating bath (50° C)	+
- Copper bath (with potassium cyanide)	+
- Copper bath (acid)	+
- Pickling bath with chemical copper plating	+
- Brass bath	+
- Bright nickel bath	+
Barium	
- Chlorure de baryum *	+
- Barium hydroxide *	+
- Barium nitrate *	-
Benzene	-
Beer	+
Calcium hypochlorite *	+
Cobalt chloride *	-
Cupric chloride *	-
Ferrous chloride *	-
Manganese chloride	-
Mercuric chloride *	-
Methylene chloride	-
Chlorine water (wet gaseous chlorine)	-
Sea water	+
Fertiliser	+
Epichlorohydrin	-
Heavy gasoline	-
White spirit	-
Turpentine	-

**6. GENERAL CHARACTERISTICS (cont.)**

**6.3 Resistance to chemicals (cont.)**

Essential oils	+
Linseed oil	+
Lubricating oil	+
Machine oil	+
Mineral oil	+
Paraffin oil	+
Fish oil	+
Castor oil	+
Silicon oil	+
Humus	+
Aqueous hydrogen sulphide	+
Hypochlorite of soda 10 %	+
Fruit juice	+
Milk	+
Chlorinated lye	+
Margarine	+
Fuel oil	+
Mercury	+
Methyl methacrylate	-
Silver nitrate *	+
Cobalt nitrate *	+
Manganese nitrate *	+
Mercuric nitrate *	+
Nickel nitrate *	+
Lead nitrate *	+
Pétrole, éther de pétrole	-
Petroleum, petroleum ether	+
Silicate (Potassium, Sodium)	+
Syrup (beetroot)	-
Sodium	
- Sodium acetate*	+
- Sodium bromate*	+
- Sodium chloride* (salt)	+
Caustic soda 40 %	+
Monomer styrene	-
Sugar	+
Trichlorethylene	-
Urine	+
Wine	+

\* all concentrations in aqueous solution

**Key : + resistant - unstable**

This information is given as a guideline only and cannot be construed as an undertaking on the part of the manufacturer.

Please contact us for specific uses.

**6.4 Resistance to ultraviolet radiation**

No notable alteration following the 7 day test with 550 W/m<sup>2</sup> power lighting (Colorimetric measurement using Lab method).

**6.5 Resistance to salt spray : 7 days (168 h)**

**6.6 Climatic characteristics**

Storage and operating temperature : - 25°C to + 60°C

## 7. MAINTENANCE

Clean surface with dry cloth or cloth soaked in soapy water.  
Do not use acetone, tar remover or trichlorethylene  
Warning : a prior test is required before using specific cleaning products.

## 8. LID PROTECTION

Cat. Nos : 695 79/80

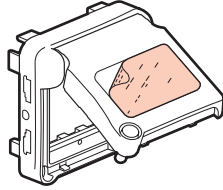

Products supplied with static lid protection film.

## 9. SPECIFIC USES



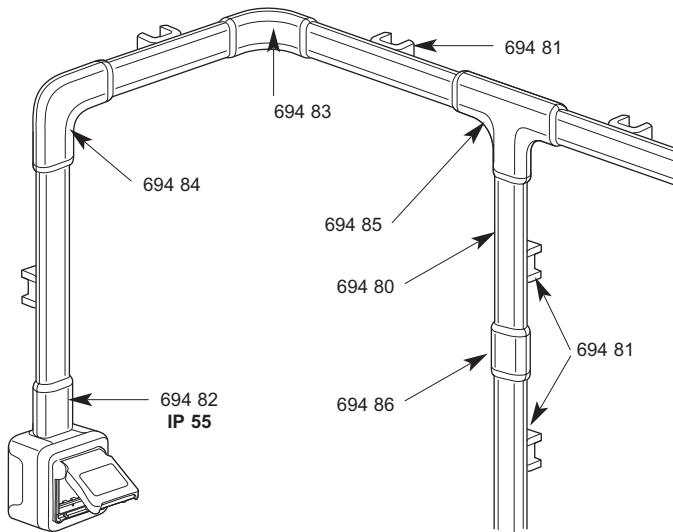



Installations with profile.  
The Plexo profile distribution system provides :  
- Distribution, protection and branch connection of various wires and cables in an electrical installation.  
- A profile, finishing and routing accessories (profile joint, weatherproof universal junction, flat angle, internal angle, external angle, branch connection, bracket).  
- A new solution for installing weatherproof surface mounting wiring devices in domestic and occasionally tertiary technical situations.  
- Optimum safety and reliability due to compliance with standard NFC 68-104 (IP 42, IK 07).

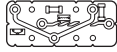

Cat. No.	Description
694 80	Plexo profile, length 2.00 m capacity equivalent to a Ø 25 mm IRL
694 81	Plexo profile bracket
694 82	IP55 weatherproof universal connection
694 83	Plexo profile internal/external angle
694 84	Plexo profile flat angle
694 85	Plexo profile tee
694 86	Plexo universal junction

- Refer to the specific technical data sheet for Plexo profile : F00386EN/00.

## 10. EQUIPMENT AND ACCESSORIES

Description	Uses	Cat. No.	Colour
	Locking tool (used to release captive screws) For Cat. No. 695 79	919 45	
Entry gland 1 entry 	Used to provide an aesthetic connection between boxes and cables up to Ø 16 mm inclusive	695 96	Grey
Entry gland 2 entries 		696 46	White
Drilling template 	Used for fast identification of mounting centre distances of all boxes	695 99	Grey
Set of 4 covers 	Used to blank mounting holes at bottom of boxes	696 49	White
Multi-cable gland (PG) Ø 7 - 14 mm		695 97	-
Standard claw 	Clips on to all one-gang flush mounting supports	695 98	Grey
Long claw 		849 00	-
Tap connection terminal block 	Direct connection after simply stripping rigid conductors Terminal capacity : 0.75 - 2.5 mm <sup>2</sup>	849 01	-
		343 22	