

LCS2 Cat. 6A RJ 45 Patch panels and units

Cat. No(s): 335 73/76

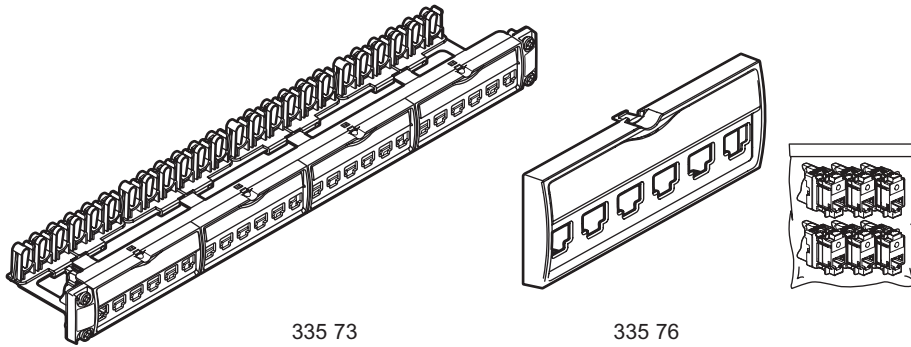

CONTENTS	Page
1. General characteristics	1
2. Presentation	1
3. Installation	1
4. Technical data	1
5. Connection	2
6. Overall dimensions	2
7. Usual connection of RJ 45 sockets	2
8. Standards and approvals	3
9. Performance	3

1. GENERAL CHARACTERISTICS

The patch panel is 19" and equipped with 4 units (24 x Cat. 6A RJ 45 sockets).

Cat. 6A units and panels are suitable for medium and large installations.

The panel is supplied with:





- 4 captive screws
- 4 universal cage nuts
- 1 label holder
- 6 sets of coloured labels, numbered from 1 to 24 (white, grey, red, blue, green, yellow).

The unit is equipped with six Cat. 6A RJ 45 connectors. It is supplied with a set of non-numbered coloured labels.

The panels offer automatic earthing of each connector with Legrand enclosures.

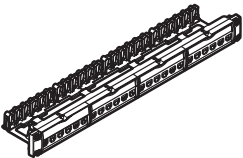
The RJ 45 connectors on the panels and units are identical, with suitable design and ergonomic features.

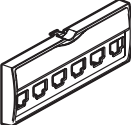
2. PRESENTATION

Designation	STP	Weight (g)
 24 x Cat. 6A STP RJ 45 patch panel	 335 73	1240
 6 x Cat. 6A STP RJ 45 patch unit	 335 76	195

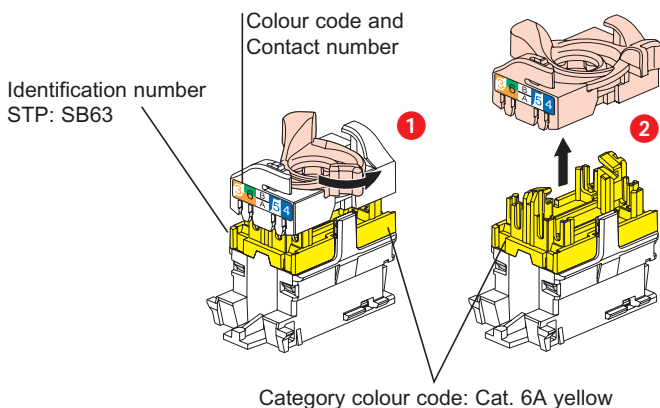

3. INSTALLATION

Connectors are attached without the need for specific tools.

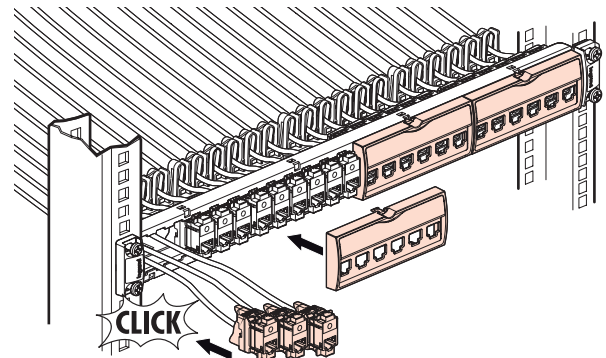

- Each connector is clipped on individually through the front of the panel
 - The label holder casing is fixed over the 6 connectors to provide a perfect finish.
- No need to attach using cable collars: cables are retained in the guides.

4. TECHNICAL DATA

4.1 Material characteristics

Panel: DC01 galvanised steel sheet
Block: RAL 9005 polycarbonate
Connector:

- Contacts: gold/nickel, thickness of gold > 0.8 µm
- Metal parts: bronze, nickel, platinum, gold
- PBT polycarbonate

For STP products the body and the spreader are made of metal alloy with a copper-nickel coating.

STP connectors are fitted with a steel ring enabling a 360° Earth connection.

4.2 Electrical characteristics

Breakdown voltage ≥ 1000 V
Contact resistance ≤ 20 mΩ
Insulation resistance ≥ 500 MΩ at 100 V DC
Connector tested and guaranteed under PoE restrictions, IEEE 802.3af and PoE+, draft standard 802.3at, up to 2500 on-load connections / disconnections.
Tests are carried out with 2 simultaneous PoE+ circuits for a minimum total power of 50 W.

4.3 Mechanical characteristics

Max. number of connections and disconnections: 5 without refreshing the wiring.
Endurance: 2500 movements (plug insertion/withdrawal).
IK03

4.4 Climatic characteristics

Operating temperature: - 40° C to + 70° C
Humid heat cycle 21 days

LCS2 Cat. 6A RJ 45 Patch panels and units

Cat. No(s): 335 73/76

5. CONNECTION

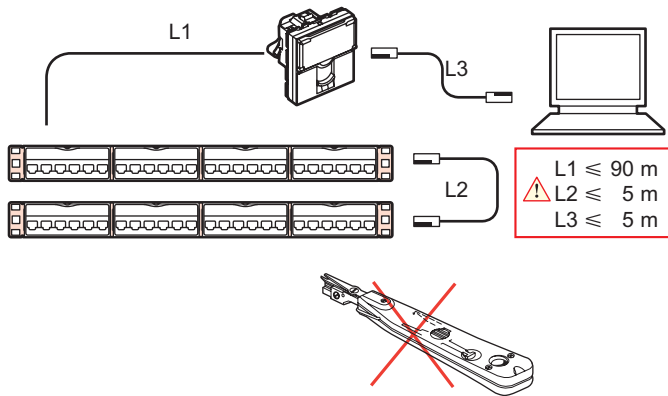

6. OVERALL DIMENSIONS

Patch panel Cat. No. 335 73

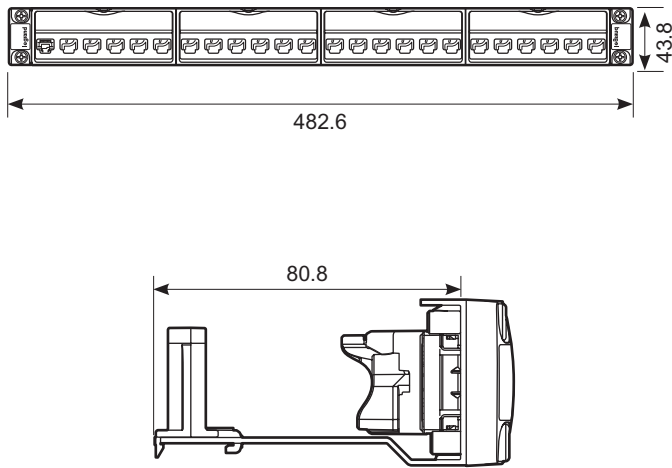

Patch unit Cat. No. 335 76

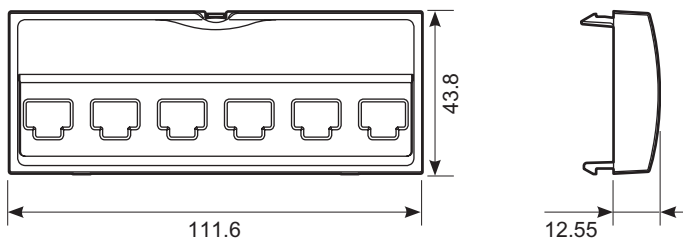

7. USUAL CONNECTION OF RJ 45s

Accepts following cable connectors:
RJ 11 (4 contacts), RJ 12 (6 contacts), RJ 45 (9 contacts).

Double colour code EIA - TIA 568 A and B on terminals:
- STP 9 contacts 360° screen

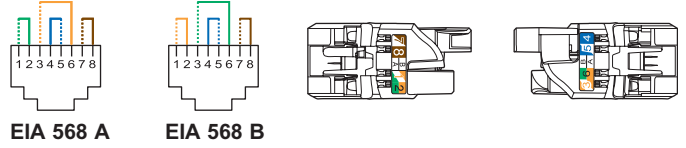

Conductors supported:

- Single-wire: 0.5 to 0.65 mm, AWG 22 to 25
- Multiple-wire: AWG 26
- Polyethylene conductor insulation: Ø max with insulation 1.58 mm.

RJ 45 connectors are equipped with a locking nut that does not require the use of a specific tool and which enables re-cabling in the event of error.

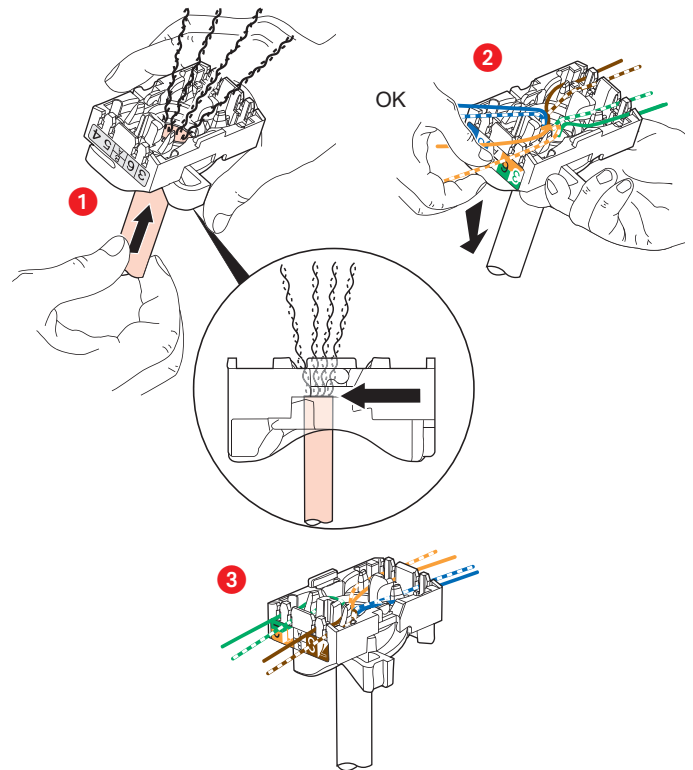

Simultaneous connection of cable strands is ensured.

This system allows the wire pairs to be spread easily before mounting them on the connector.

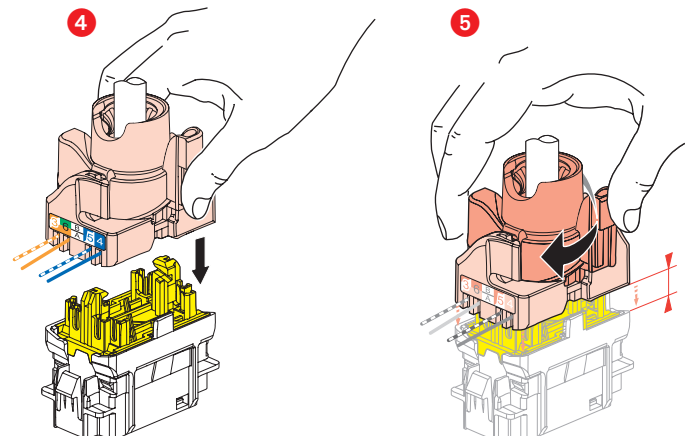

LCS2 Cat. 6A RJ 45 Patch panels and units

Cat. No(s).: 335 73/76

7. USUAL CONNECTION OF RJ 45s (cont.)

Spreading cables ensures that each pair is separated by the specified 13 mm.
Spreading pairs by 90° in relation to the cable ensures optimum performance.

8. STANDARDS AND APPROVALS

Compliant with standards: ISO 11801 Second edition
EN 50173 Second edition
EIA/TIA-568-B.2
NF C 20730
Standard 8877 – 603.7

9. PERFORMANCE

9.1 Performance of permanent link with F/UTP cable

Return loss

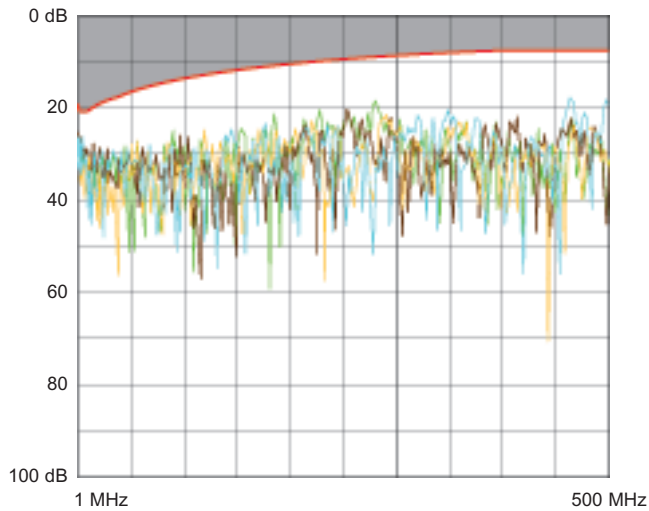

Attenuation

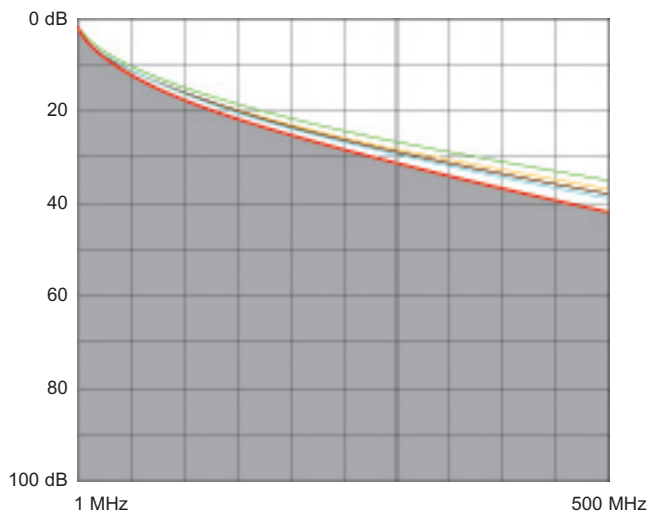

9. PERFORMANCE (cont.)

9.1 Performance of permanent link with F/UTP cable (cont.) NEXT (Near end Crosstalk Attenuation)

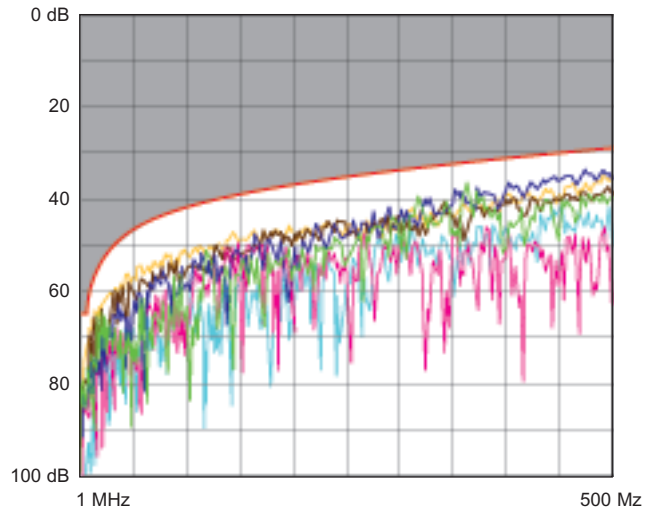

PS NEXT (Power Sum NEXT)

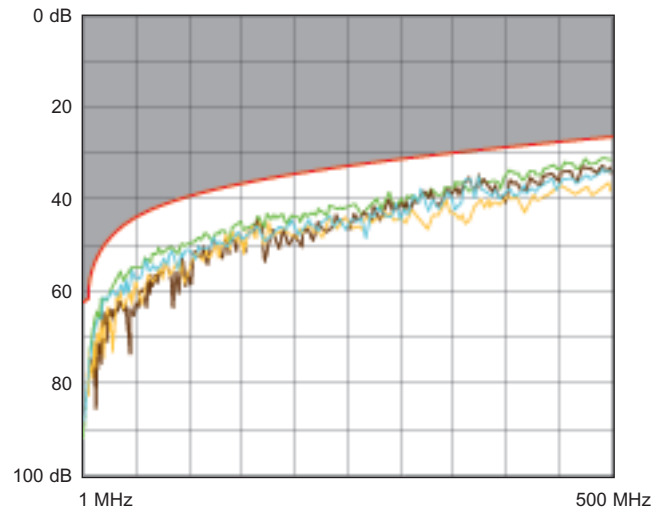

ACR (Attenuation to Crosstalk Ratio)

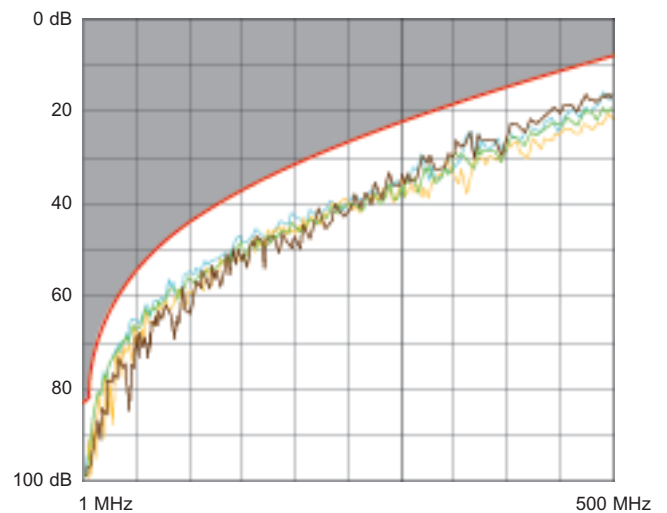

9. PERFORMANCE (cont.)

9.1 Performance of permanent link with F/UTP cable (cont.)
 ELFEXT (Equal Level End Crosstalk Attenuation)

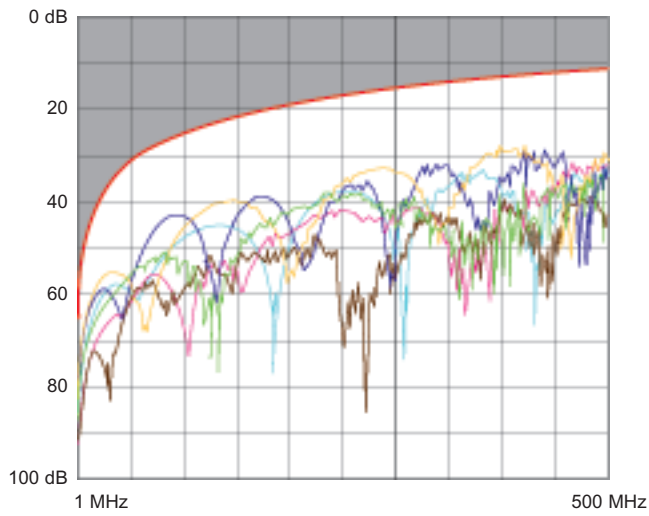

Delay skew

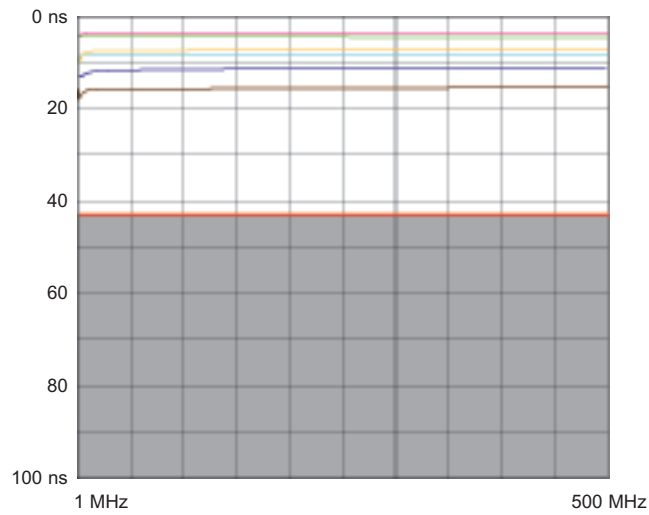

9.2 Performance of permanent link with S/FTP cable
 Return loss

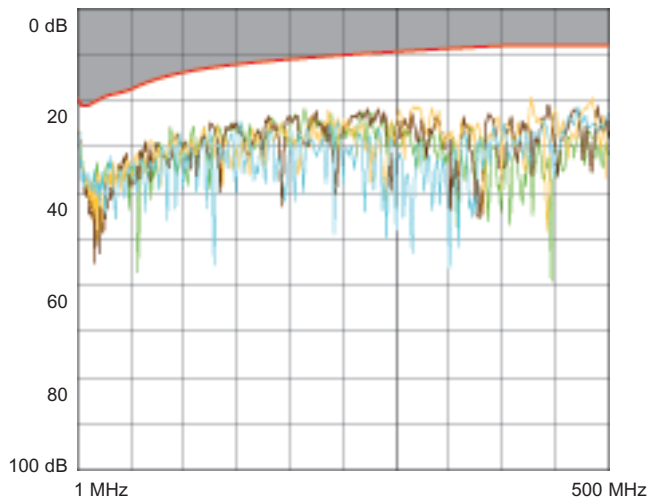

9. PERFORMANCE (cont.)

9.2 Performance of permanent link with S/FTP (cont.)
 Attenuation

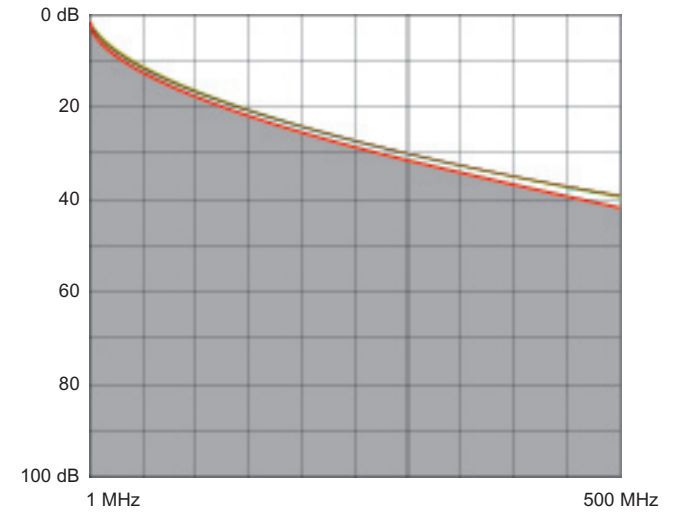

NEXT (Near end Crosstalk Attenuation)

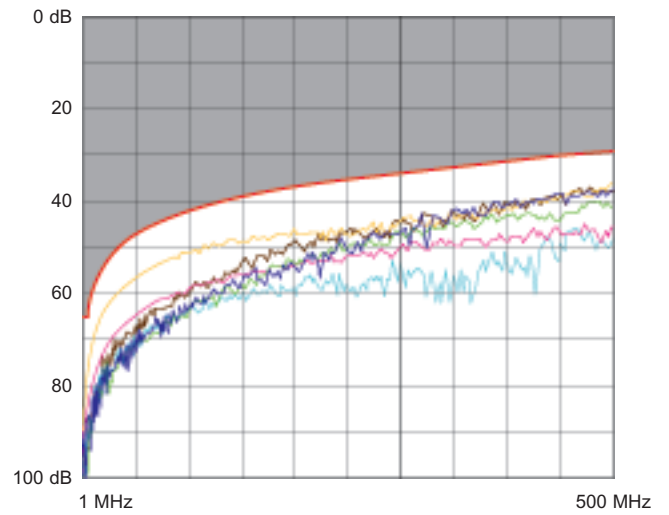

PS NEXT (Power Sum NEXT)

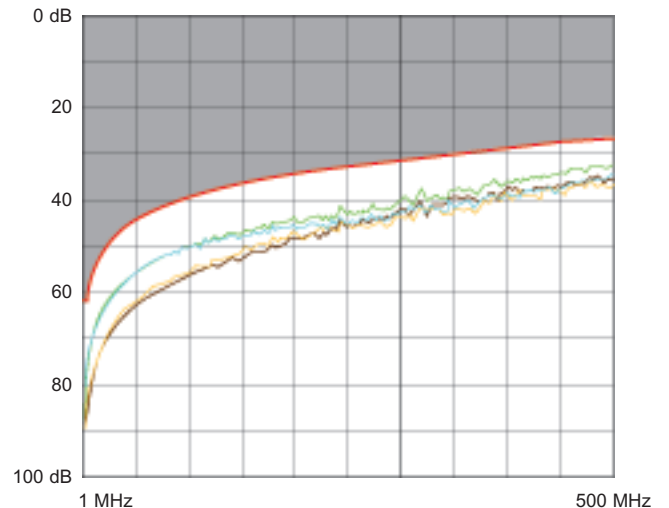

9. PERFORMANCE (cont.)

9.2 Performance of permanent link with S/FTP cable (cont.)
 ACR (Attenuation to Crosstalk Ratio)

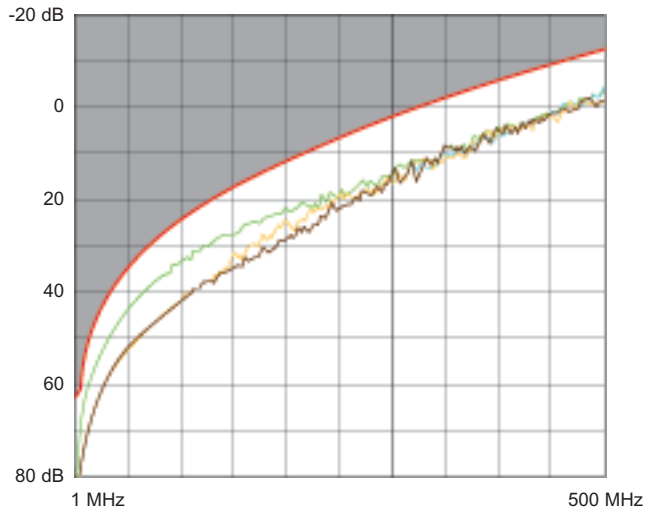

ELFEXT (Equal Level End Crosstalk Attenuation)

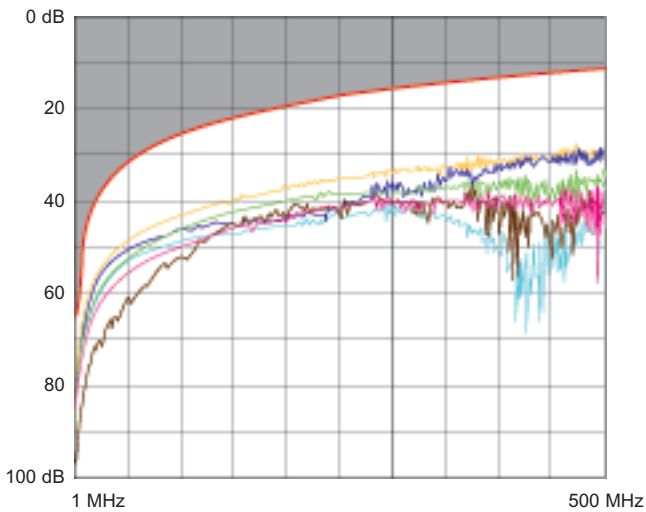

Delay skew

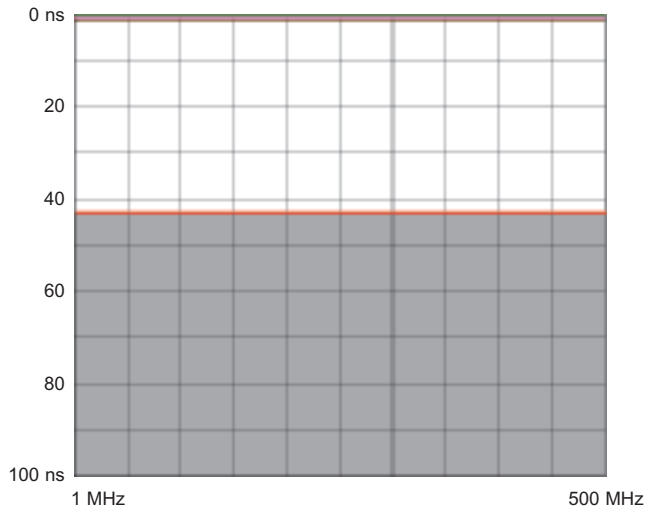

9. PERFORMANCE (cont.)

9.3 Channel performance
 Return loss

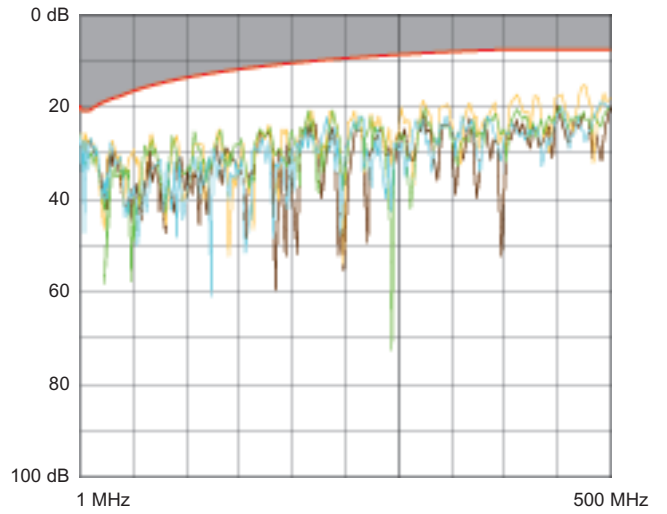

Attenuation

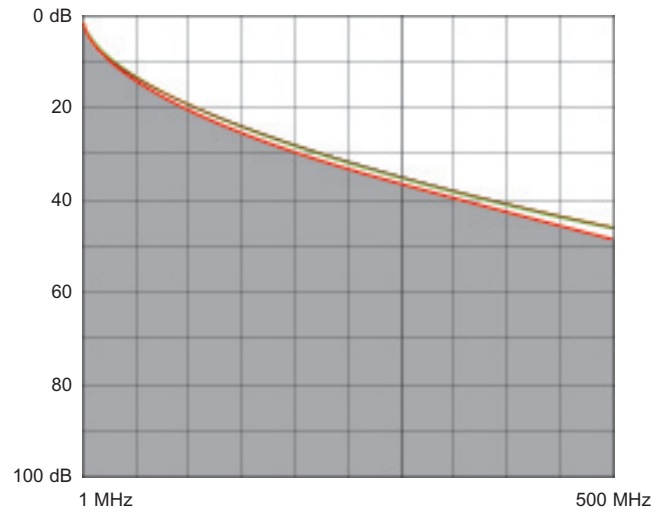

NEXT (Near end Crosstalk Attenuation)

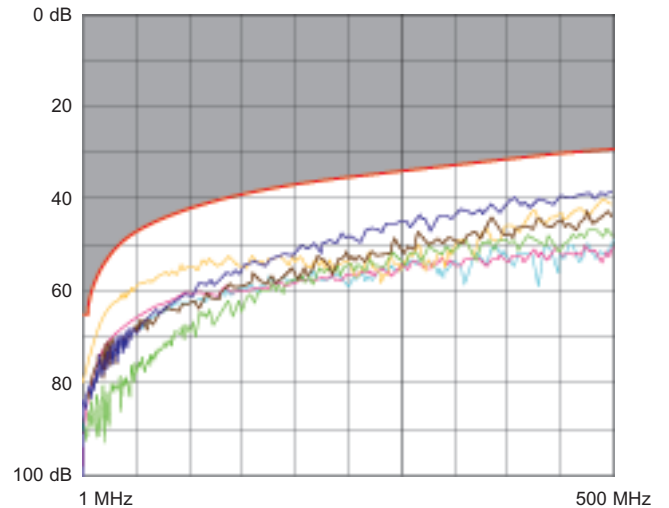

9. PERFORMANCE (cont.)

9.3 Channel performance (cont.)
 PS NEXT (Power Sum NEXT)

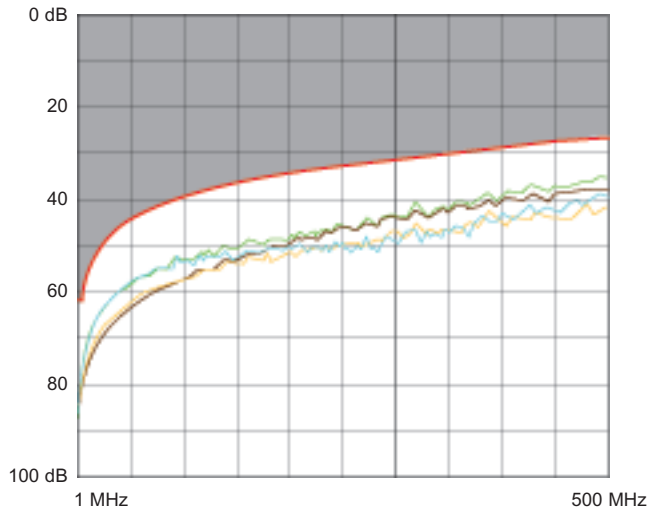

ACR (Attenuation to Crosstalk Ratio)

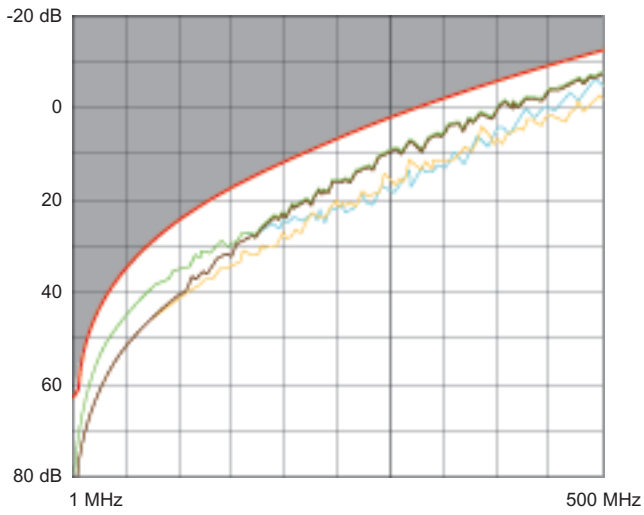

ELFEXT (Equal Level End Crosstalk Attenuation)

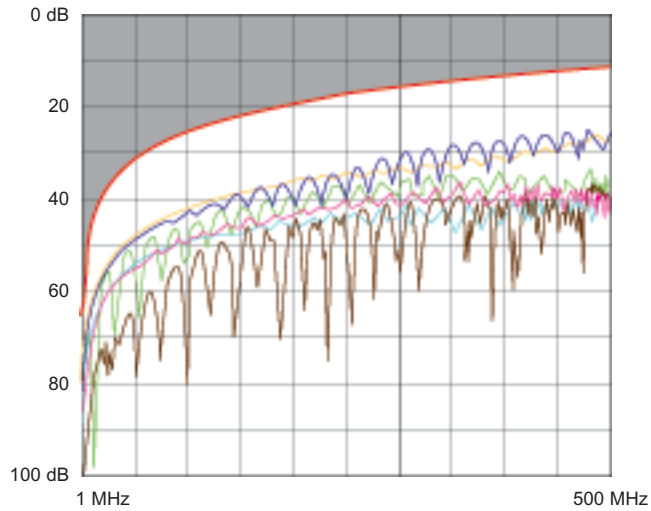

9. PERFORMANCE (suite)

9.3 Channel performance (cont.)
 Delay skew

