

Solutions for retirement homes & healthcare establishments



Bedhead strips/Nurse call unit & Assistance with independent living



A major player in the services sector, with SELV solutions, emergency lighting, VDI, etc., Legrand has long had a presence in healthcare establishments.

Today it offers new innovative solutions around the concept of the room where energy performance, assistance with independent living, comfort and convenience for the staff and patient or resident are its key concerns.



CONTENTS

Antimicrobial LED bedhead strips	2-3
Antimicrobial medical bedhead strips.....	4-5
Antimicrobial magnetic hand-held remote control unit	6-7
Antimicrobial BUS/SCS nurse call unit	8-9
Automatic lighting for assistance with independent living	10-11
Monitoring of the room.....	12-13
Structured cabling for the room	14-15
Antimicrobial wiring accessories.....	16
Secure wandering	17
Other equipment with remote management and control	18-19
Services - support.....	20
Catalogue pages.....	21-36

Antimicrobial LED bedhead strips



Anti-extraction magnetic socket, for hand-held control device, integrated into the bedhead strip.



Digital connections within easy reach thanks to the RJ 45 socket integrated into the bedhead strip.

For retirement homes, specialised accommodation, etc.

Dynamic lighting with LED bedhead strips

Discover new comfort in the room with the LED bedhead strip. Visual comfort created by the light from the LEDs: softness and automatic variation of the indirect lighting, quality and contrasting of the direct lighting. And LEDs mean energy savings. An end to relamping! No maintenance for the lifetime of the bedhead strip. And that's not all: by playing on the lighting colours the LED bedhead strip can recreate the natural light cycle - dynamic lighting, which limits the appearance of time phase lags in the resident. Another innovation: all connectors integrated into the bedhead strip within easy reach. For connecting the lighting, connecting the nurse call unit, the telephone, the nurses' special equipment. Imagine the new level of convenience for the nurse at work. Think of the interpersonal facilities that are offered to the resident. And an antimicrobial treatment is applied to all surfaces for maximum hygiene.



Noon: white light

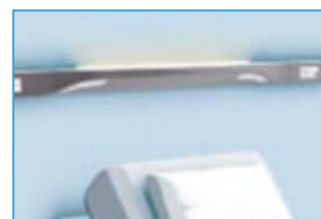

Morning: yellow/white light

Dynamic lighting allows the resident to stay in touch with concepts of day and night.



Evening: yellow/orange light

Antimicrobial medical bedhead strips



An alliance of different technologies:
magnetic socket of the hand-held remote
control unit and 2P+E power socket.



Connection of medical appliances with the Cat. 6A FTP socket.



Equipped bedhead (example)

For healthcare establishments such as: clinics, hospitals, etc.

Light and ergonomics

Combining ergonomics and aesthetics, the antimicrobial bedhead strip, connected to the trunking for gases, makes it easier to implement and maintain the systems: electricians and gas engineers can work separately. A true technological hub working for the patient's comfort and the convenience of the nursing staff. The bedhead strip, fitted with three luminaires, produces light that is suitable for each situation: room, reading, nursing. It also includes all the special connection sockets: hand-held remote control unit, nurse call unit, medical computer equipment, etc.

The bedhead strips comply with the EN 60598-1, EN 60598-2-25, EN 12464-1 standards.

The trunking complies with the FDS 90-155 standard.

Antimicrobial magnetic hand-held remote control unit

Legrand innovation: the magnetic connection allows ejection in all directions without damage.

Antimicrobial: hand-held remote control unit and cord



The patient can control the lighting, shutters, radio (switched socket) without moving thanks to the functions of the magnetic connection hand-held remote control unit.

Ejectable without extraction

Innovation: the hand-held remote control unit ejectable without extraction

The Legrand hand-held remote control unit is innovation in a nutshell. Ergonomic controls within easy reach for calling the nurse using a large red backlit button, as well as for controlling the light, roller shutters, etc. Connected to the bedhead strip via a magnetic socket it is ejectable in all directions without any risk of extraction. Its IP 67 properties and antimicrobial treatment guarantee its long life and make it easier to clean: exclusive to Legrand.

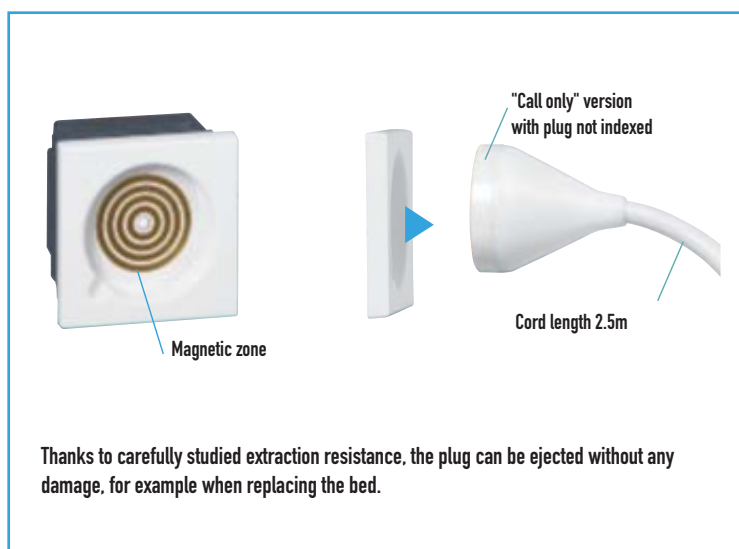

Antimicrobial BUS/SCS nurse call unit

1



The patient remains in continuous contact with the nursing staff thanks to the door unit located in the room. The associated interphone option can be used for initial remote vocal processing of the call, call acknowledgement, etc.

2



The corridor bulkhead light indicates the urgency of the call and the presence.

6



Call, presence, acknowledgement... the door unit contributes to the efficiency of the nursing staff.

5



The call is forwarded in real time to the nurse's DECT.

Free to do what they like, more available for patients: forwarding the nurse's call to the DECT allows the nursing staff to have the information in real time and to process calls with optimum efficiency.

3



Additional signalling with the alphanumerical corridor display: shows where the calls are coming from and their priority: room or bathrooms.



4



From the control unit, on a desk or on the wall, the nurse receives and manages call priorities. The nurse can also connect with colleagues in the rooms using the interphone option.

Linked directly to the DECT*

Efficiency and traceability

The nurse's call from a hand-held remote control unit is signalled on the door unit display installed in the rooms. It is relayed via the bulkhead light on the corridor side: wherever they are the nursing staff know who is calling and from where the call is coming, whether the bed or the bathrooms. The associated interphone unit can be used to reassure and acknowledge remotely, or to make a general call to all rooms with a nurse present. At the same time the information is displayed on the control unit installed in the central office and it can be transferred to the nurses' DECT: the information supplied directly to the rooms can be used to increase the nurses' efficiency. The system complies with standard VDE 834-1 and guarantees that events can be traced.

*DECT: Digital Enhanced Cordless Telephone

BUS/SCS: easy to configure

Installation by BUS/SCS of the door units and control units is made easier: just one BUS cable to be pulled. For small and medium-sized structures configuration can be completed by any electrical contractor.

Automatic lighting for assistance with independent living



Signalling bulkhead light with low-intensity lighting integrated into the bedhead strip.



The Mosaic automatic switch plays a role in assistance with independent living: it detects a presence and then orders a low-intensity lighting to be switched on which is reassuring but not blinding.



Illuminated bulkhead light on above the entrance to bathrooms.



A guarantee of safety: multiple detection angles.

Finding one's bearings in the room and the bathrooms at night

Finding one's bearings in the room at night

The spatial markers fade away when darkness sets in. A resident who is sitting at the edge of the bed can automatically trigger diffuse lighting in the room thanks to the automatic detectors installed approximately 30 cm off the ground. Several detection angles must be crossed in order for the system to work with maximum efficiency. The resident's path can be made easier by installing additional bulkhead lights and a signalling unit above the bathroom door - reassurance, dignity, independent living.

Automatic lighting in the bathrooms

The bathroom lighting provided via an infrared/ultrasonic detector allows the resident to move around in total safety: their presence and slightest movements are detected, whether they are in the toilets, in the shower or somewhere else.

The light goes off automatically when they leave the room.



Legrand innovation: the infrared/ultrasonic detector detects the resident's presence and slightest movements (for toilets, shower, etc.)

Monitoring of the room

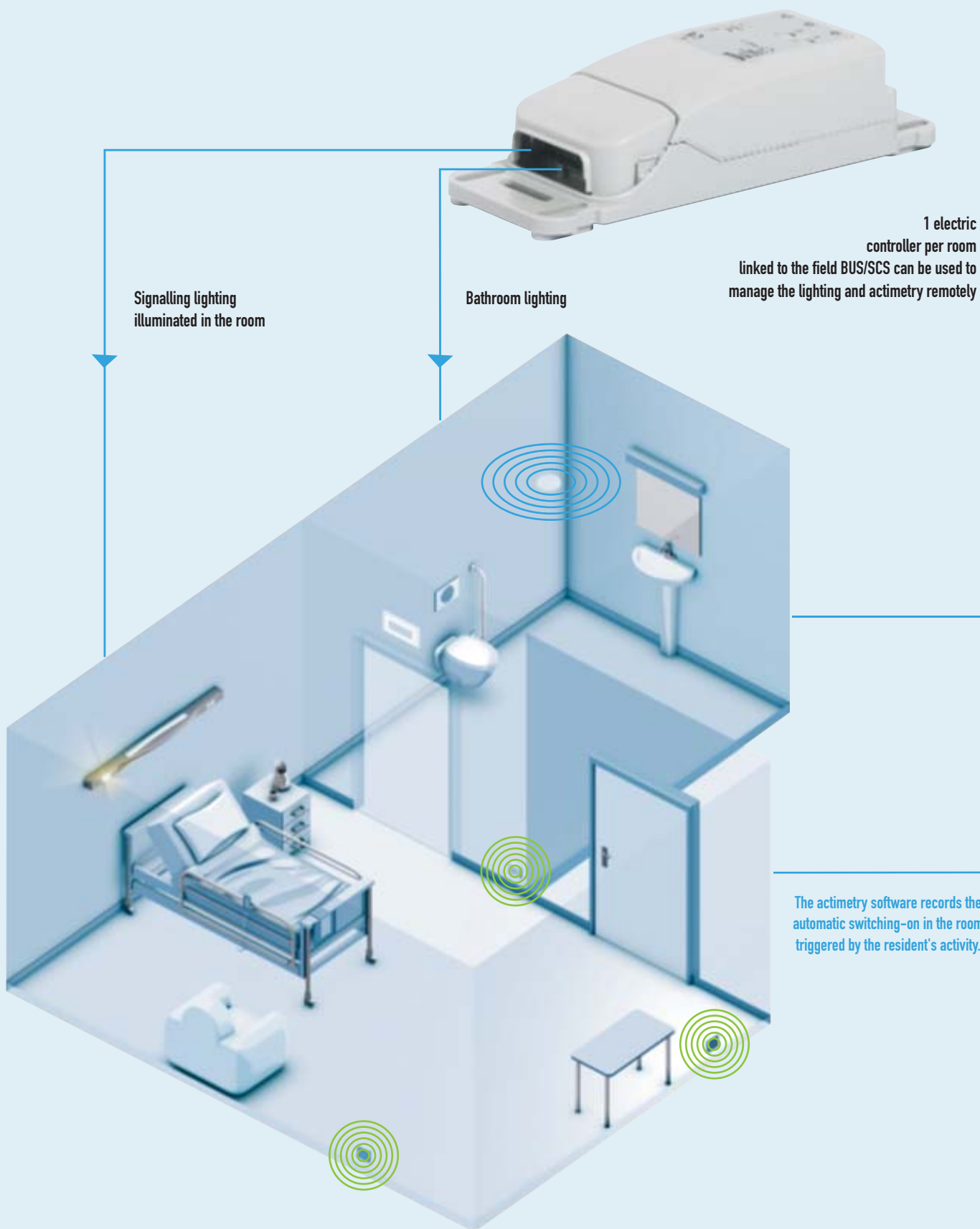

Monitor behaviour in addition to providing assistance with autonomous living

For maximum efficiency among the nursing staff

All automatic detectors (room and bathrooms) are linked to a controller. Thanks to the field BUS/SCS, the controller sends all information emitted by the detectors related to the devices being switched on/off.

As such, using the actimetry software the nursing staff will be able to display and trace a resident's activity during the night in their room and in the bathrooms.

Option for controlling the lighting, shutters and ventilation

Monitoring the condition of the lighting, roller shutters, ventilation, etc. from the nurses' station. Option of controlling remotely from a PC.

The switch-on command issued by the bathroom detector is recorded and can be used to monitor how frequently the location is used.



The nurse can display residents' activity in their rooms and bathrooms from the computer in their own office.

Example:

- 22:30 the resident goes to bed.
- 22:45, the light goes out in the room.
- 00:10, the resident gets up.
- 00:11, they go into the bathroom.
- 00:35, light goes off in the bathroom and in the room.

Structured cabling for the room



The cat. 6A performance of the LCS² components (sockets) and connections (cords) have been validated by independent laboratory 3P Third Party Testing (see www.xxxxxx.xx VDI-LCS² system section)



Remote management & remote consultation

The VDI* infrastructure

Legrand's LCS² system can be used to exchange information for all applications (telephone, Internet, computer, images) from one part of the building to another from one shared network. Legrand offers a comprehensive and adaptable cat. 6A system, up to 10GB capacity, from the patch panel to the terminal sockets. System performance is guaranteed for 20 years!

*VDI: Voice, Data, Image

Manage from the room terminal

Having a computer terminal in the room optimises the medical staff's work and improves patient comfort.

- Connected to the network this terminal can be used for direct and secure access to the medical file, brought to the patient as closely as possible.
- The touch screen allows the room's "comfort" functions to be controlled.
- There is also a telephone, Internet and videos on demand.

Performance linked to the quality of the Legrand VDI infrastructure.

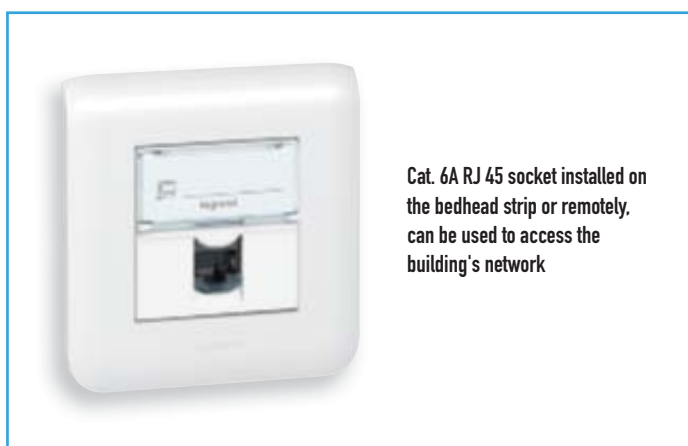

Cat. 6A RJ 45 socket installed on the bedhead strip or remotely, can be used to access the building's network

Antimicrobial wiring accessories

Destruction of the bacteria sodium ions via the silver ions of the wiring accessories

The antimicrobial asset

The antimicrobial effect of wiring accessories stems from the construction of their material based on silver ions Ag+. This technology means that the Legrand antimicrobial range can guarantee the non-proliferation of bacteria, viruses and fungi without creating any immunisation or resistance effects (physical destruction and not chemical). It acts in particular on the staphylococcus aureus cells resistant to antibiotics from the methicillin family. The effectiveness of Legrand's antimicrobial products has been tested by the authorised COFAC laboratory: at least 99.99% of the bacteria tested were eliminated. The usual cleaning procedures must however be retained in order to guarantee perfect hygiene.

All essential functions with antimicrobial action

With more than fifty functions available Legrand offers a real range of antimicrobial wiring accessories designed for healthcare establishments.



Secure wandering device

In addition to its room solutions, which make up its “core business”, Legrand offers a secure wandering system in order to provide an overall solution for the needs of retirement homes and healthcare buildings.

Secure wandering

This involves controlling the path of movement of a long-stay patient or in an Alzheimer’s care unit. Fitted with a wristband that transmits a signal, it triggers an alarm as soon as one of the building thresholds defined by the operator and equipped with a detection aerial has been crossed. The alarm can be sent directly to the nurses’ control unit and to the DECT via a door unit. The event can be traced using the dedicated software.

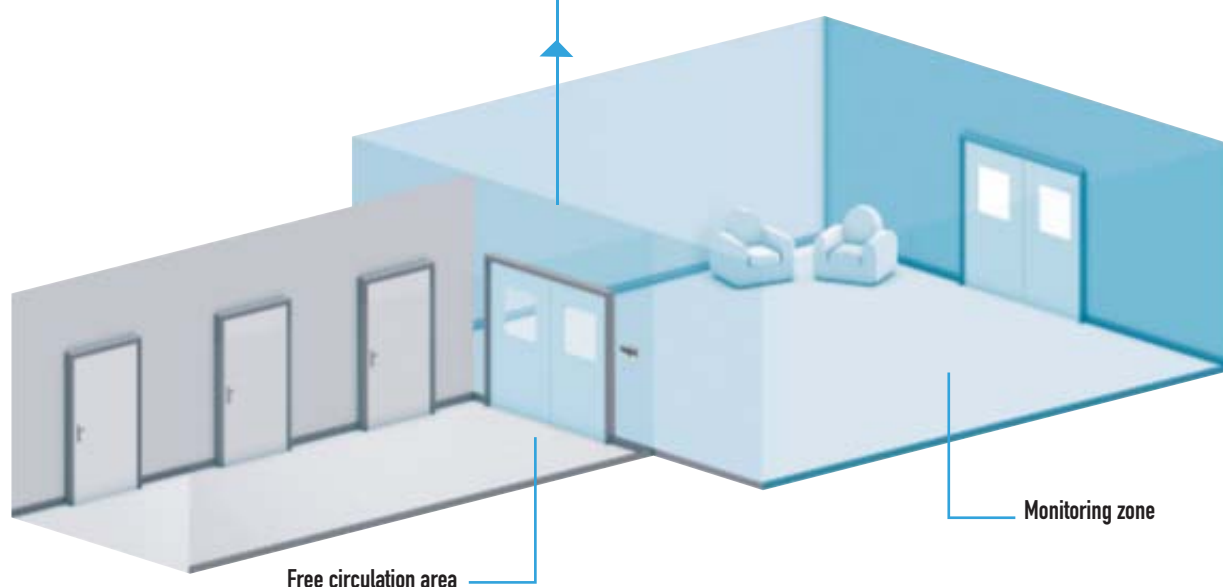
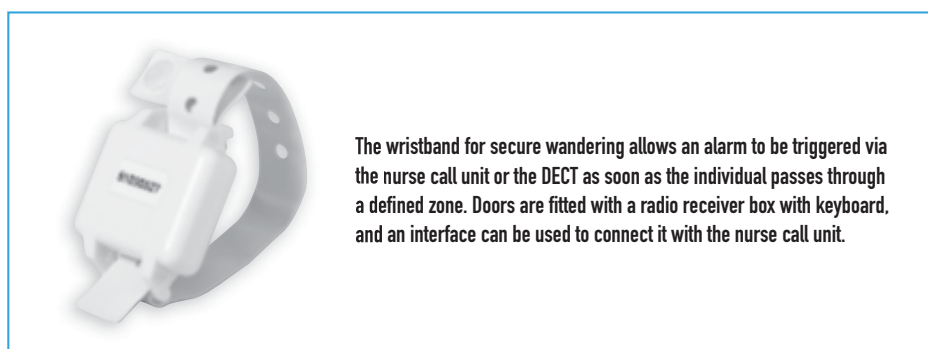

Other equipment with remote management and control

To guarantee energy performance in healthcare buildings

In addition to the equipment and antimicrobial products dedicated to the rooms in healthcare establishments, Legrand also offers a coherent set of solutions for guaranteeing energy performance in commercial buildings and optimising their maintenance. Energy and time savings into the bargain: all institutions controlled and monitored from the PC screen.

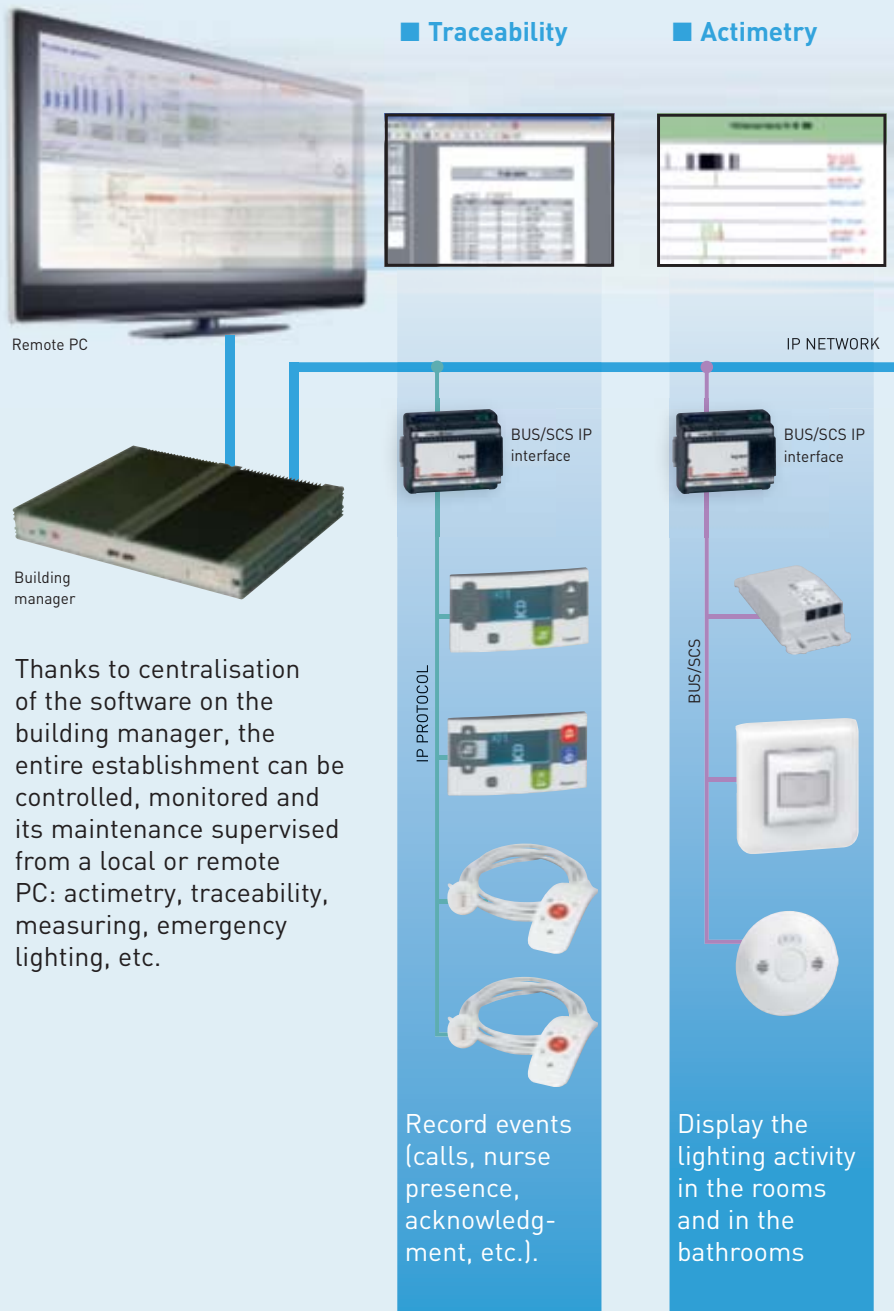

Thanks to centralisation of the software on the building manager, the entire establishment can be controlled, monitored and its maintenance supervised from a local or remote PC: actimetry, traceability, measuring, emergency lighting, etc.

■ Power



■ Emergency lighting



■ Fire



■ Lighting management



■ Access control

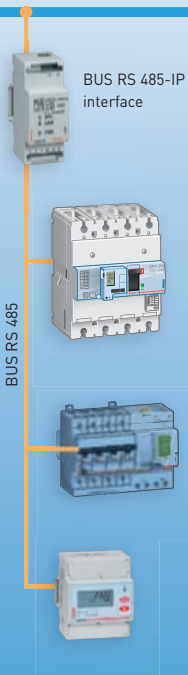
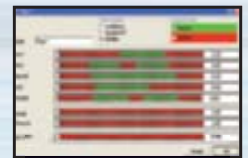

Measure the quality and amount of energy consumed.



Monitor the entire installation of the emergency lighting units.



Monitor the operation of the type 1 fire alarm (transfer possible to DECT).

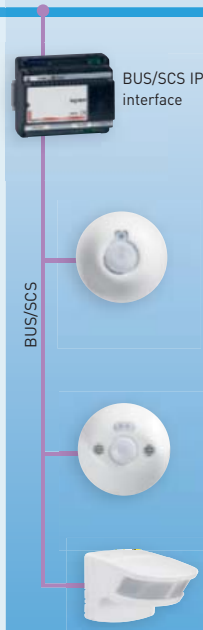

Manage lighting consumption and facilitate relamping.

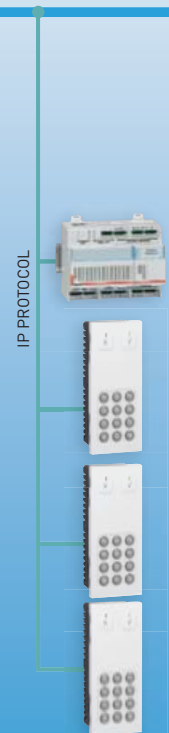

Control access and monitor the installation in centralised mode.

Services - support

Legrand
supports you
throughout
your project

TRAINING

- Learn about the Legrand offering and system
- Customised training based on your project



STUDY

- Help with drawing up Special Technical Specifications
- Study of made-to-measure solutions



OPERATION

- Typical maintenance stock proposals to suit the project
- Customised training for maintenance services
- 2 year guarantee for products and maintainability for 10 years



Catalogue pages



Non-medical bedhead strips	22
Medical bedhead strips	24
Lighting to assist with independent living: standalone solution	26
Lighting to assist with independent living: BUS/SCS system solution and actimetry	27
Nurse call	29
Signalling and acknowledgement devices for rooms	30

Signalling devices for nurses' station.....	31
Secure wandering	33
Call devices for day hospitals	34
Mosaic antimicrobial functions	35



bedhead strips

for non-medical establishments



Technical characteristics **p. 36**
 Antimicrobial Mosaic mechanism selection table **p. 36**

Perfectly suitable for retirement homes, establishments providing a low level of medical care and the home

Pack	Cat.Nos	LED bedhead strips
		Very low consumption LED lighting with an estimated lifetime of 100,000 hours IP 20 - IK 04 Aluminium material, grey, antimicrobial Resistance to incandescent wire: 850 °C Class I Ra or TCI: 80 Colour T°: 6,500 °K Complies with standards EN 60598-1, EN 60598-2-25, EN 12464-1
1	783 30	Reading only light LED reading lighting Bedhead strip with remote control for reading Strip length: 0.97m
1	783 31	Bedhead strip fitted with an antimicrobial pull cord switch Modular: 3 modules on one side and 4 antimicrobial Mosaic modules on the other side of the strip Compatible with BUS/SCS nurse call unit (p. 30): can be fitted with a remote control socket Strip length: 1.40m

Pack	Cat.Nos	LED bedhead strips (continued)
		Reading and room lighting LED reading and room lighting Compatible with BUS/SCS nurse call unit (p. 30): can be fitted with a socket for hand-held remote control unit
1	783 32	Extendable bedhead strip: 4 antimicrobial Mosaic modules on each side of the strip Strip length: 1.40 m
		Bedhead strip fitted with antimicrobial Mosaic mechanisms - 1 blanking plate 2 modules - 1 two-way switch for room lighting - 1 pull cord switch for reading Strip length: 1.40 m
1	783 34	2 x 2P+E F/B standard sockets
1	783 87	2 x 2P+E German standard sockets

Antimicrobial

bedhead strips for non-medical establishments



783 38



783 41
room lighting
with variation

Technical characteristics p. 36
Antimicrobial Mosaic mechanism selection table **p. 36**

Perfectly suitable for retirement homes, establishments providing a low level of medical care and the home

Pack	Cat.Nos	LED bedhead strip with dynamic lighting
		<p>Very low consumption LED lighting with an estimated lifetime of 100,000 hours IP 20 - IK 04 Aluminium material, grey, antimicrobial Resistance to incandescent wire: 850 °C Class I Ra or CRI: 80 Colour T° = 2,500 to 6,500 °K Complies with standards EN 60598-1, EN 60598-2-25, EN 12464-1</p> <p> Dynamic reading and room lighting For automatic management of the lighting colour (white to amber) depending on the time of day so as to reduce cognitive deficiencies Fitted with light level cell for automatic adjustment of the light intensity in accordance with the natural light level LED reading and room lighting Bedhead strip fitted with antimicrobial Mosaic mechanisms: - 1 blanking plate 2 modules and 1 blanking plate 1 module - 1 pull cord switch for reading Compatible with BUS/SCS nurse call unit (p. 30): can be fitted with a socket for hand-held remote control units Strip length: 1.40m</p>
1	783 35	2 x 2P+E F/B standard sockets
1	783 36	2 x 2P+E German standard sockets

**Available
January 2012**

Pack	Cat.Nos	LED/Fluorescent bedhead strips
		<p>IP 20 - IK 04 Aluminium material, grey, antimicrobial Resistance to incandescent wire: 850 °C Class I Complies with standards EN 60598-1, EN 60598-2-25, EN 12464-1 LED reading lighting Fluor T5 tube room lighting with electronic ballast Can be fitted with a socket for hand-held remote control units</p> <p>Reading and room lighting Extendable bedhead strip: 4 antimicrobial Mosaic modules on each side of the strip Strip length: 1.47m</p> <p>Bedhead strip fitted with antimicrobial Mosaic mechanisms - 1 blanking plate 2 modules - 1 two-way switch for room lighting - 1 pull cord switch for reading Strip length: 1.47m</p>
1	783 38	2 x 2P+E F/B standard sockets
1	783 40	2 x 2P+E German standard sockets
1	783 60	2 x 2P+E German standard sockets
		<p>Reading and room lighting with variation Bedhead strip fitted with antimicrobial Mosaic mechanisms: - 1 blanking plate 2 modules and 1 blanking plate 1 module - 1 pull cord switch for reading Room lighting variation possible via pushbutton, pull cord pushbutton and/or hand-held remote control unit Strip length: 1.47 m</p>
1	783 41	2 x 2P+E F/B standard sockets
1	783 42	2 x 2P+E German standard sockets



BUS/SCS nurse call unit with magnetic connection
See p. 29



Pushbutton and two-way switch with ejectable pull cord **p. 25**



bedhead strips

for medical establishments, clinics, hospitals, etc.



783 46



783 47



Magnetic connection socket (p. 25) for hand-held remote control unit on bedhead strip Cat. No. 783 48



Example of Cat. No. 785 10 integrated into the bedhead strip



Example of trunking 783 50 with supports for assembling 2 ALS sockets 783 51

Technical characteristics p. 36
Antimicrobial Mosaic mechanism selection table p. 36

Perfectly suitable for medical environments. Complies with current lighting standards: EN 60598-1, EN 60598-2-25, EN 12464-1
 Separate lighting and gas devices to allow electricians and gas engineers to carry out product maintenance in total safety

Pack	Cat.Nos	Fluorescent T5 bedhead strips
		IP 20 - IK 04 Aluminium material, grey, antimicrobial Lighting via T5 tube with electronic ballast: - 300 lux over the reading area - 100 lux for room lighting Option of adding the standby module Cat. No. 785 10 To be fitted with a remote control module for controlling lighting or roller shutters (p. 25) via hand-held remote control units (p. 29) Allows annual savings to be made for an installation of 80 bedhead strips (equivalent to 2 hospital wards for example), calculation in comparison with use of T8 tube ferromagnetic bedhead strips Resistance to incandescent wire: 850°C Class I Ra or TCl: 80 Colour T°: 4,000 °K Complies with standards EN 60598-1, EN 60598-2-25, EN 12464-1
1	783 45	Strip for equipment by customer, length 1.20 m Room lighting: 1 x 39 W Reading light: 1 x 24 W Extendable strip: 8 modules Equipped strip, length 1.20 m Room lighting: 2 x 24 W Reading light: 1 x 24 W 8-module bedhead strip fitted with antimicrobial Mosaic mechanisms: - 1 blanking plate 2 modules - 1 two-way switch for room lighting - 1 ejectable pull cord switch for reading
1	783 46	2 x 2P+E F/B standard sockets
1	783 86	2 x 2P+E German standard sockets
1	783 85	Strip for equipment by customer, length 1.60 m Room lighting: 2 x 39 W Reading light: 1 x 24 W 16 modules Equipped strip, length 1.60 m Room lighting: 2 x 39 W Reading light: 1 x 14 W Examination lighting: room + reading + 1 x 14 W Complies with standard NFX 90-003-1 for examination lighting: 300 lux on the bed 16-module bedhead strip fitted with antimicrobial Mosaic mechanisms: - 2 blanking plates 2 modules - 1 switch for examination lighting - 1 RJ 45 socket, Cat. 6 FTP to be wired - 1 two-way switch for room lighting - 1 ejectable pull cord switch for reading
1	783 47	2 x 2P+E F/B standard sockets
1	783 97	2 x 2P+E German standard sockets

Pack	Cat.Nos	Fluorescent T5 bedhead strips (continued)
		Equipped strip, length 1.60 m (continued) Room lighting: 2 x 28 W Reading light: 1 x 24 W Examination lighting: room + reading + 1 x 24 W 16-module bedhead strip fitted with antimicrobial Mosaic mechanisms: - 1 magnetic socket Cat. No. 782 45 for call and lighting control hand-held remote control units - 2 modules - 1 blanking plate 1 module (x 2) - 1 switch for examination lighting - 1 RJ 45 socket, Cat. 6 FTP to be wired - 1 blanking plate 2 modules
1	783 48	2 x 2P+E (x 2) F/B standard sockets
1	783 88	2 x 2P+E (x 2) German standard sockets
1	785 10	Standby module for bedhead strip 2 modules White antimicrobial
4	783 50	Trunking for gas sockets IP 40 Aluminium material, grey, antimicrobial Complies with the standards on medical gases FDS-90-155 Supplied in 3m lengths, adjustable Takes medical gas sockets with supports Cat. No. 783 51/52/53
1	783 51	For assembling the gas sockets on trunking Cat. No. 783 50
1	783 52	Aluminium material, grey, antimicrobial
1	783 53	For assembling ALS socket
		For assembling DKD socket
		For assembling Caouet socket



BUS/SCS nurse call unit with magnetic connection

See p. 29



control units for bedhead strips

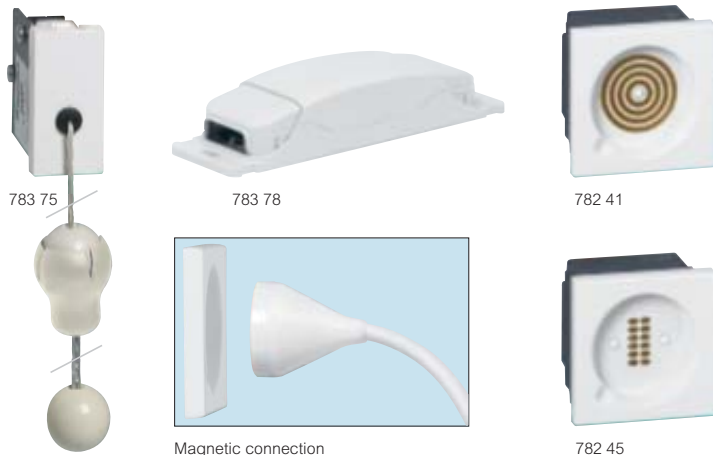

Pack	Cat.Nos	Lighting control units
1	783 75	Two-way switch with ejectable pull cord 1-module switch 230 V - 2 A White antimicrobial Grey antimicrobial cord
1	783 76	Pushbutton with ejectable pull cord 1 module 230 V - 2 A White antimicrobial Grey antimicrobial cord

230 V~ remote control modules

1	783 77	Boxes for controlling lighting or other SELV functions via hand-held remote control units For mounting in the bedhead strips Connected via screw terminals Used to control 4 lighting circuits (for example: room, reading, nursing, standby, etc.) Compatible with hand-held remote control unit Cat. No. 782 42 (p. 29) Dimensions: 230 x 71 x 44 mm
1	783 78	Used for controlling 2 lighting outputs (room and reading) as well as the roller shutters (up, down) and 1 x 16 A all-function outlet Compatible with hand-held remote control unit Cat. No. 782 44 (p. 29) Dimensions: 230 x 71 x 44 mm
1	783 79	Used for controlling 2 lighting outputs (room with varying light and reading) with level storage, roller shutters (up, down) and 1 x 16 A all-function outlet Compatible with hand-held remote control unit Cat. No. 782 44 (p. 29) Dimensions: 230 x 71 x 44 mm

2-module socket mechanisms for hand-held remote control unit

1	782 41	Socket for hand-held remote control unit for call only Magnetic connection without locating device for hand-held remote control unit Cat. No. 782 40 (p. 29) White antimicrobial
1	782 45	Socket for hand-held remote control units Magnetic connection for hand-held remote control units Cat. No. 782 42/44 (p. 29) White antimicrobial

made-to-measure bedhead trunking unit



INSTALLATION AND EQUIPMENT

For other configurations, please contact us

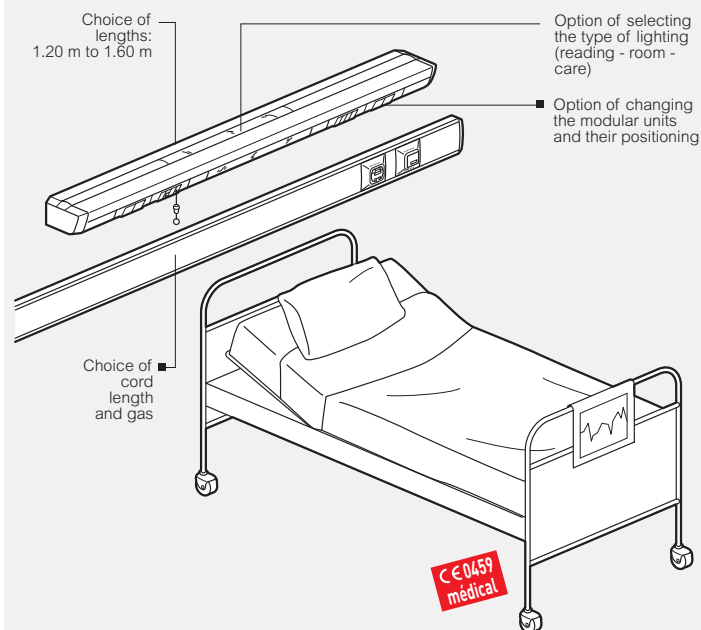





- Choice of AFE lighting level, ferromagnetic or electronic ballasts
- Inlet options: - from the right or left-hand side

lighting to assist with independent living

standalone solution

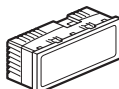

Stand-alone automatic lighting device which allows the patient to get their bearings and make their way to the bathrooms

Pack	Cat.Nos	For installation in the room	Pack	Cat.Nos	For installation in bathrooms
1	784 51	<p>Combination of automatic switches and illuminated signalling</p> <p>Automatic switch with neutral, 3 wire For installation at a maximum of 30 cm from the ground in order to pick up the patient's movements once out of bed Allows triggering of the lighting and the illuminated signalling Installing 2 or 3 detectors per room is advisable for optimum movement detection Infrared detection Detection range adjustable from 3m to 10m Horizontal detection angle: 180° Light level threshold adjustable from 3 to 1,000 lux Time delay adjustable from 1s to 16 mins with repetition of cycle as long as movement is detected For installation in box depth 40mm min. For flush-mounted installation use plate Cat. No. 788 22 and support Cat. No. 802 51 2 modules</p> <p>○ White</p> 	1	488 06	<p>False ceiling detector switch</p> <ul style="list-style-type: none"> Operating mode: <ul style="list-style-type: none"> - Vacancy sensing: switched on manually via push-button, switched off automatically via detector or by pressing push-button - Occupancy sensing: switched on and off automatically - Factory pre-set to occupancy sensing mode. Vacancy sensing mode activated by mobile configurators • Light level threshold factory pre-set to 500 lux • Factory pre-set time delay 15 minutes. Walkthrough function activated (short time delay of 3 minutes for 1 walkthrough) • Site adjustment with mobile configurators Cat. No. 882 30/35 • Serial wiring Phase + Neutral + Source With terminals to connect the push-button(s) including push-buttons with LED indicator Cat.Nos 770 40/33 • For controlling light sources: <ul style="list-style-type: none"> - 2,000 W max 230 V halogen - 1,000 VA max ELV halogen, fluorescent bulb with ballast - 500 W max with compact fluorescent light and LED Recommended fixing height: 2.50 m Fixed directly to a false ceiling with mounting claws (provided) or installed in Batibox flush-mounting box with depth of 50mm Surface mounted with accessory Cat. No. 488 75 Infrared and ultrasonic detector 360° This dual technology allows presence to be detected precisely as soon as the wave issued by the detector is modified Consumption 0.8 W on standby Connection via automatic terminals
5	785 20	<p>2-module illuminated signalling For flush-mounted installation use plate Cat. No. 788 22 and support Cat. No. 802 51 2 choices of power rating (0.2 W or 1 W)</p> <p>Signalling with white LEDs</p> 	1	787 15	<p>Push-button</p> <p>For controlling the false ceiling detector switch in vacancy sensing For installation next to the bathroom door Fast connection via automatic terminals, no tool required For flush-mounted installation use plate Cat. No. 787 22 and support Cat. No. 802 51</p> <p>○ White antimicrobial</p> 
1	785 10	<p>For 230 V - 0.2 or 1 W illuminated standby 2 modules</p> <p>○ White antimicrobial</p> 	10	785 22	<p>Illuminated signalling for top of door Mechanism incorporating LEDs and a pivoting window which can take pre-printed labels Option of downloading labels from e-catalogue for printing 5 modules For flush-mounted installation use plate Cat. No. 788 15 and support Cat. No. 802 52</p> <p>Signalling with white LEDs (1 W)</p> 

lighting to assist with independent living

BUS/SCS system solution and actimetry



784 90



488 22







488 41

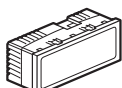

026 45

Automatic lighting BUS/SCS device which allows:
 - the patient to find their bearings and make their way to the bathrooms
 - the doctor and nursing staff to monitor resident behaviour remotely

Pack	Cat.Nos	For installation in the room
1	784 90	<p>Combination of automatic switches and illuminated signalling</p> <p>BUS/SCS automatic detector For installation at a maximum of 30 cm from the ground in order to pick up the patient's movements once out of bed Allows triggering of the lighting and the illuminated signalling Installing 2 or 3 detectors per room is advisable for optimum movement detection Infrared detection Detection range adjustable from 3 m to 10 m Horizontal detection angle: 180° Light level threshold adjustable from 3 to 1,000 lux Factory pre-set time delay 15 minutes Repetition of cycle as long as movement is detected Walkthrough function activated, time delay of 3 minutes For installation in box depth 40mm minimum Supplied pre-assembled with finishing plate in white and 2-module support 2 modules</p> <p> <input type="radio"/> White</p> <p>2-module illuminated signalling For flush-mounted installation use plate Cat. No. 788 22 and support Cat. No. 802 51 2 choices of power rating (0.2 W or 1 W)</p> <p> Signalling with white LEDs</p> <p>For 230 V - 0.2 or 1 W illuminated standby 2 modules</p> <p> <input type="radio"/> White antimicrobial</p> <p>Illuminated signalling for top of door Mechanisms incorporating LEDs and a pivoting window which can take labels Labels can be customised and printed using LAB LX², XL Pro² or LCS Pro software, or with a simple text editor (visuals in PDF format are available in the e-catalogue) For standard or transparent printing paper 1 state - 5 modules For flush-mounted installation use plate Cat. No. 788 15 and support Cat. No. 802 52</p> <p> Signalling with white LEDs (1 W)</p>

Pack	Cat.Nos	For installation in bathrooms
1	488 22	<p>False ceiling BUS/SCS automatic detector Fixed directly to a false ceiling with mounting claws (provided) or installed in Batibox flush-mounting box with depth of 50mm Recommended fixing height: 2.50m 360° infrared and ultrasonic detector This dual technology allows accurate presence detection from the point where the signal given by the detector is interrupted (e.g. : limited movement of a resident when in the bathrooms) Consumption 0.5 W on standby</p>
1	784 75	<p>ON/OFF lighting control  For controlling the false ceiling detector switch in vacancy sensing For installation next to the bathroom door <input type="radio"/> White For flush-mounted installation use plate Cat. No. 788 22 and support Cat. No. 802 51</p>
		System products
1	488 41	<p>BUS/SCS controllers 2 outputs For managing the room's illuminated signalling in conjunction with detector Cat. No. 784 90 2 x 16 A outputs False ceiling 2 x 2 A outputs Modular devices</p>
1	038 42	<p>Zone management unit Includes 2 functions: - manages scenario programming (e.g. time management, lighting, presence)) - IP interface, provides the link between the BUS/SCS infrastructure and the IP network Approximately one zone management unit per 20 rooms Requires power supply unit Cat. No. 035 64 6 x 17.5 mm DIN modules</p>
1	634 42	<p>Zone management unit power supply Power supply 220-240 V - 50/60 Hz Output 1-2 27 V_± - 600 mA 2 modules DIN 17.5 mm</p>
1	035 60	<p>BUS/SCS power supply 230 V_~ - 27 V_± - 1.2 A 8 x 17.5 mm DIN modules</p>
1	492 33	<p>BUS/SCS cable Length 200 m Non-halogen cable</p>

Lighting actimetry software (p. 28)

lighting to assist with independent living

BUS/SCS system solution and actimetry (continued)



Screenshot of actimetry software Cat. No. 783 80



035 44

Pack	Cat.Nos	Lighting actimetry
1	783 80	Actimetry software For recording activity in rooms and bathrooms Any activity is tracked by the triggering of detectors and low-level lights (illuminated signalling) and other lighting being turned on Option of programming detection levels to be recorded depending on the level of light (e.g.: night, nap time, etc.) and time slots Option of a 24-hour display for rooms with heavy activity and to categorise them Installing the software on building manager Cat. No. 035 44 is recommended
1	035 44	Building manager Ensures communication of the Modbus-Bacnet protocols, storing and information history Can be used to centralise the following software packages: - lighting actimetry Cat. No. 783 80 - traceability Cat. No. 766 18 (p. 31) - Legrand: lighting management and measurement (see p. 18-19)

lighting to assist with independent living

BUS/SCS system solution and actimetry

■ BUS/SCS wiring architecture for actimetry

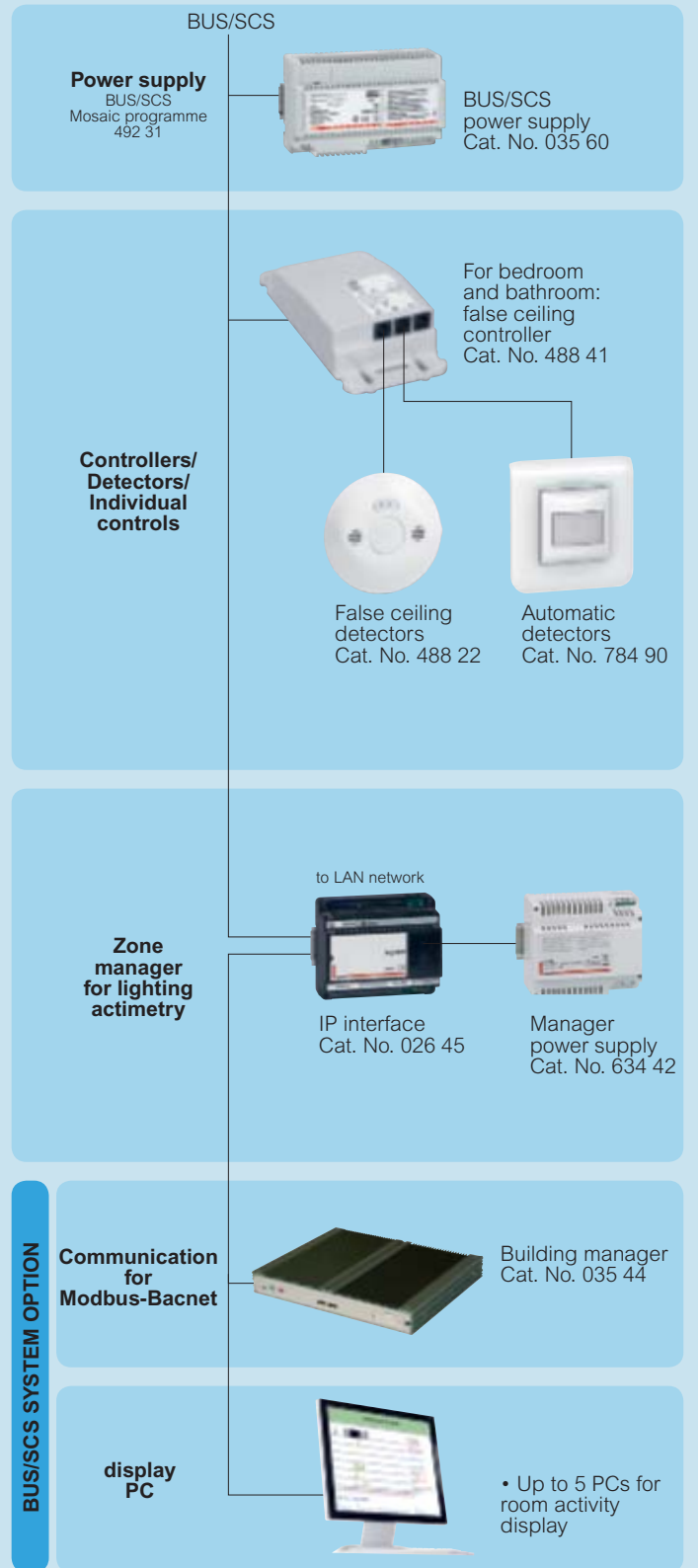

nurse call

call devices for rooms and bathrooms

Compatible with all
Legrand nurse call
systems



782 40



782 46 non indexed



782 44



782 42



782 47



782 48



782 43

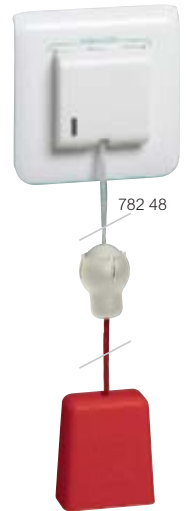

Technical characteristics p. 36

Parts used for calling a nurse
Information report on door unit and control unit for nurses' station
Compatible with all Legrand nurse call systems

Pack	Cat.Nos	Call devices for rooms
6	782 40	<p>Antimicrobial: hand-held remote control unit and cord</p> <p>White antimicrobial Magnetic connection between hand-held remote control unit and socket: can be ejected in all directions with pull-out torque designed to avoid any damage to the equipment</p> <p>Hand-held remote control unit for call only IP67 waterproof hand-held remote control unit: - designed ergonomically for ease of handling - 1 call button and red indicator for call confirmation - visible at night via 2 illuminated LEDs - fitted with a 2.5 m cord For use in conjunction with socket Cat. No. 782 41</p>
6	782 42	<p>Call and lighting control hand-held remote control unit IP 67 waterproof hand-held remote control unit: - designed ergonomically for ease of handling - 1 call button and red indicator for call confirmation - visible at night via 2 illuminated LEDs - 1 button for reading light control - 1 button for room light control Fitted with a 2.5 m cord For use in conjunction with socket Cat. No. 782 45</p>
6	782 44	<p>Hand-held control unit for calls and controlling lighting and roller shutters IP 67 waterproof hand-held remote control unit: - designed ergonomically for ease of handling - 1 call button and red indicator for call confirmation - visible at night via 2 illuminated LEDs - 1 button for reading light control - 1 button for room light control - 2 buttons for controlling roller shutters - 1 free function button (example: switched socket) Fitted with a 2.5 m cord For use in conjunction with socket Cat. No. 782 45</p>
1	782 46	<p>Sockets for hand-held remote control units Supplied pre-assembled with finishing plate in white, antimicrobial and 2-module support</p> <p>Non-indexed magnetic connection socket for hand-held remote control unit Cat. No. 782 40</p>
1	782 47	<p>Magnetic connection socket for hand-held remote control units Cat. No. 782 42/44</p>
5	782 43	<p>Accessory for hand-held remote control units Clamp for holding the hand-held remote control unit within reach: on bedding, clothes, a chair arm, the edge of the bed, etc.</p>

Pack	Cat.Nos	Call devices for bathrooms
1	782 48	<p>Mechanisms supplied with support and finishing plate in white, antimicrobial</p> <p>Ejectable call pull cord Bathroom call pull cord, IP55 waterproof, ejectable With red indicator for call confirmation Fitted with height-adjustable handle Red antimicrobial cord Can be installed in a shower at a height of 2.20 m</p>
1	766 85	<p>Call unit Antimicrobial bathroom call pushbutton With red indicator for call confirmation IP 20 IP 44 with plate Cat. No. 788 80 (p. 35)</p>
1	782 49	<p>Call devices for specific environments</p> <p>Waterproof call unit IP55 waterproof call unit Mechanism supplied with support and finishing plate in white With red indicator for call confirmation Suitable for damp environments (e.g.: rehabilitation and recovery centres with swimming pool, steam room, sauna, etc.)</p>
1	782 51	<p>High-resistance call unit Call unit with high resistance to impacts IK 10 and to humidity IP X5 Grey metallic alloy With red indicator for call confirmation Suitable for psychiatric and penal institutions, etc. Supplied pre-assembled with plate and support</p>
1	771 50	<p>Biomedical call devices for bedrooms or special rooms 1 module</p> <p>Socket mechanism for biomedical calls Signals the end of a cycle via an alarm on the nurse call unit system For connecting portable electrical medical appliances such as syringe pumps, respirators, etc. 12 mm fixing centre ○ White antimicrobial</p>
1	782 07	<p>Shunt plug Shunt plug for biomedical alarm standby 12 mm fixing centre Used with socket Cat. No. 771 50</p>

BUS/SCS nurse call unit

signalling and acknowledgement devices for rooms

Antimicrobial



766 06



766 07



766 08



782 00

BUS/SCS system with star wiring around the door unit:

- call centralisation
- acknowledgement
- communication with nursing control unit and all elements of the system via BUS/SCS
- signalling forwarded to all indicators (e.g.: corridor overhead light unit, door unit, hand-held remote control unit)

Door units for rooms

Pack	Cat.Nos	
1	766 06	<p>For installation at the entrance to the room, can be seen from the bed Connect directly to the BUS/SCS cable Cat. No. 492 32/33 With indicator and pushbutton for calls, nurse presence and 2nd nurse presence Comply with standards VDE 0834-1 and 0834-2 Fault display 4-module wiring mechanisms supplied complete Flush mounting with flush-mounting box for Mosaic with depth 50 mm or surface mounting with frame Cat. No. 766 14 (p. 31) Antimicrobial</p> <p>Door unit with indicators Door unit with illuminated call indicators Nurse presence and acknowledgement via pushbutton. Audible and illuminated signal of a call coming from another room Suitable for shared bathrooms and for secure wandering</p>
1	766 07	<p>Door unit with display Door unit with alphanumeric display Nurse presence and acknowledgement via pushbutton. Call display from another room Used in conjunction with the interphone unit Cat. No. 766 09 for communicating with rooms issuing calls and with a nurse present User is able to acknowledge at the end of the communication</p>

Interphone unit for room and nurses' station

1	766 08	<p>Interphone door unit For installation: - at the entrance to the room connected to the door unit with display Cat. No. 766 07 - in the nurses' room linked to the control unit Cat. No. 766 11 (p. 31) Allows the user to: - communicate from one room to another room issuing a call or with a nurse present - broadcast a general call Must be connected to a microphone Cat. No. 782 00 for communication between the patient and the nursing staff 4-module wiring mechanism supplied complete Flush mounting with flush-mounting box for Mosaic with depth 50 mm or surface mounting with frame Cat. No. 766 14 (p. 31) Antimicrobial</p>
1	782 00	<p>Room microphone Remote microphone for connection to the interphone unit Cat. No. 766 08 For installation next to the bed. For communication between the patient and the nursing staff. 2-module mechanism. Supplied pre-assembled with finishing plate in white and 2-module support</p>

BUS/SCS nurse call unit

corridor signalling devices



766 70



766 04



Technical characteristics p. 36

Ensures that information is transferred into the corridor

Pack	Cat.Nos	Corridor signalling devices
1	766 71	<p>For installation in the corridor above the doors Supplied with support and white finishing plate Flush-mounting or surface-mounting.</p> <p>Call only corridor overdoor light unit LED triangular overdoor light unit for call signalling 1 red indicator For call signalling 2 modules</p>
1	766 70	<p>Call and nurse presence corridor overdoor light units LED triangular overdoor light units for call signalling, bathroom calls and nurse presence Recommended for compliance with standards VDE 0834-1 and 0834-2 Monobloc indicator in red, white, green 2 modules</p>
1	766 04	<p>Corridor display unit For installation in the corridor 10 character alphanumeric display White Indication of calls and nurse presence by level of priority For fixing in false ceiling or on the wall Supplied with connection interface to the BUS/SCS Double sided display unit</p>
1	766 05	<p>Fixing accessory for corridor display unit For fixing a corridor display unit projecting</p>

BUS/SCS nurse call unit

signalling devices for nurses' station



Technical characteristics **p. 36**

Pack	Cat.Nos	Control units
		<p>Call and presence display for all bedrooms and rooms in order of priority (max. 150) 4-module wiring mechanism supplied with support For flush-mounted installation in flush-mounting box depth 50 mm or on inclined plane Cat. No. 766 12/13 Antimicrobial With alphanumeric display and adjustable audible signal Scrolled display of the calls and nurse visits in progress Fitted with a malfunction indicator Used in conjunction with the interphone unit Cat. No. 766 08 allows:</p> <ul style="list-style-type: none"> - communication with the bedrooms issuing calls and with a nurse present - call acknowledgement at communication end - calls to be made to all rooms with a nurse present <p>Connects directly to the BUS/SCS cable Cat. Nos 492 32/33</p> <p>Main control unit</p> <p>1 766 11 For installation in the nurses' station</p> <p>Secondary control unit</p> <p>1 766 09 Can be used in addition to the main control unit in another room (break room, dining room, etc.) or in a corridor</p>

Pack	Cat.Nos	BUS/SCS cables
		Supplied on a reel
1	492 32	Length 500 m
1	492 33	Length 200 m Non-halogen cable

Pack	Cat.Nos	Fixing accessories
		For control units
1	766 12	Inclined plane for fixing control unit only onto table
1	766 13	Inclined plane for fixing control unit + interphone unit onto table
		For control units, door units and interphone units
1	766 14	Frame surface mounted for refurbishment

Pack	Cat.Nos	Call transfer interface to DECT
1	766 19	Interface for forwarding information as ESPA 444 protocol to the DECT system (text messages only) 2 x 17.5 mm DIN modules

Pack	Cat.Nos	Traceability on PC
		Traceability software
1	766 18	<p>Memorises and categorises events by information type (calls, nurse presence, acknowledgement, etc.) Time stamping of events Export of the elements as .csv files which can be used on a PC Works with traceability interface Cat. No. 766 17 to be ordered separately</p> <p>Traceability interface</p> <p>1 766 17 Works with call traceability software Cat. No. 766 18 2 x 17.5 mm DIN modules</p>
		Building manager
1	035 44	<p>Allows communication of the Modbus-Bacnet protocols, storing and information history Can be used to centralise the following software packages:</p> <ul style="list-style-type: none"> - lighting actimetry Cat. No. 783 80 - traceability Cat. No. 766 18 (p. 31) - Legrand: lighting measurement and management (see p. 18-19)

BUS/SCS nurse call unit

system products



035 60



766 10



261 45

Pack	Cat.Nos	SELV power supplies
1	035 60	For BUS/SCS Secure power supply 230 V~ - 27 V= - 1.2 A 8 17.5 mm DIN modules
1	782 90	For indicators For overdoor light units with bulb or LED 230 V/24 V - 2.5 A power supply For mounting in modular cabinet 6 modules
BUS/SCS extension		
1	766 10	For communicating information between 2 BUS/SCS nurse call systems Used where departments are grouped together or for departments with more than 80 rooms (e.g.: nursing homes, residential homes for the elderly, etc.)
Physical configuration of the installation		
Suitable for establishments with fewer than 80 rooms		
Configuration using a configurator Used to associate an address with the different system components Kit with configurators 0 to 9 (10 configurators for each digit)		
1	261 45	↑↓
5	492 20	
Virtual configuration of the installation		
Recommended for installations above 80 rooms		
Configuration via PC Virtual configuration software For installations of 0 to 150 departments For use with interface Cat. No. 766 16 (to be ordered separately) for connecting a PC		
1	766 15	
Configuration kit Interface for connecting a PC and the installation Works with software Cat. No. 766 15		
1	766 16	

BUS/SCS nurse call unit

system products

Example diagram of the BUS/SCS nurse call device for a 50 room ward

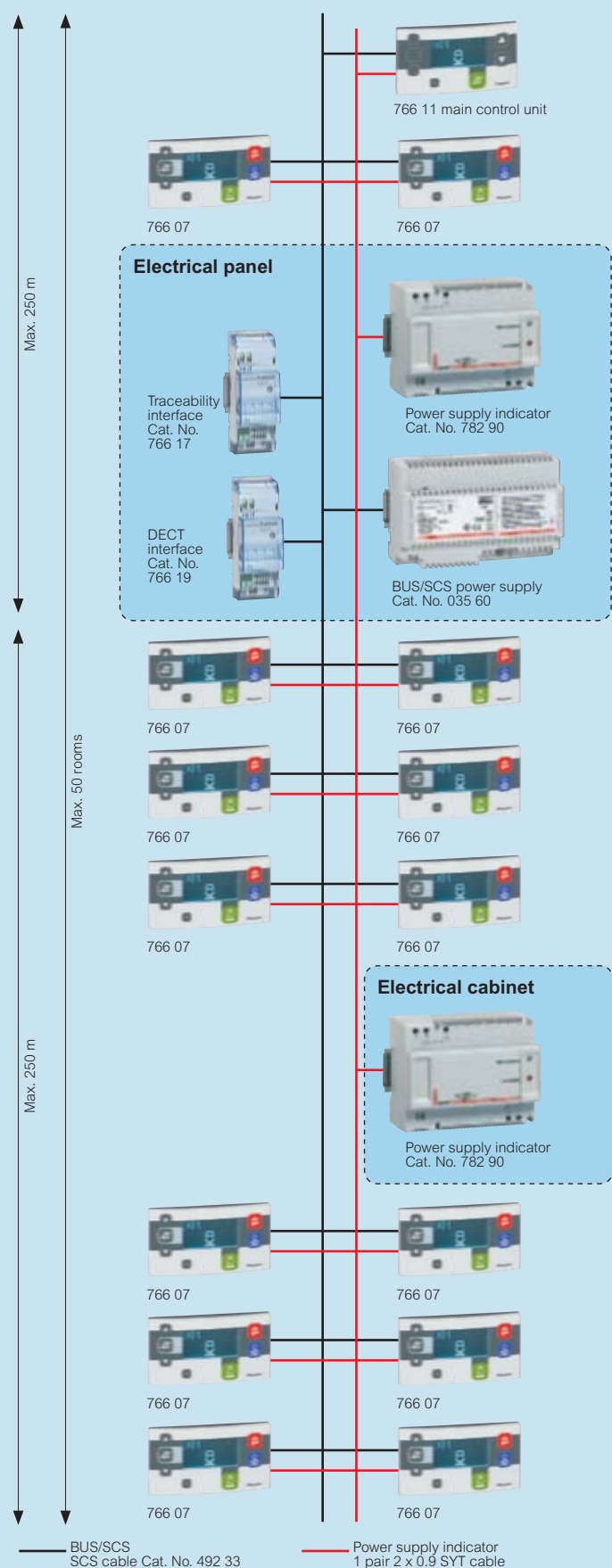

BUS/SCS nurse call unit

secure wandering device



766 20



766 22



431 00



408 96



767 09



767 08

Pack	Cat.Nos	Secure wandering device
1	766 20	<p>Indicates that a door has been crossed by the resident fitted with the device Works with door unit Cat. No. 766 06 configured for secure wandering and allowing acknowledgement Simultaneous alarm transmission over DECT</p> <p>Ring Fitted with 869 MHz radio transmitter Anti-allergy White Permanent fixing</p>
1	766 21	<p>Aerial Receives the ring signal and transmits it to the controller</p>
1	766 22	<p>Door controller Coded keypad for capturing the ring's signal when a certain door has been crossed Works with aerial Cat. No. 766 21</p>
1	766 06	<p>Door unit With illuminated escape indicator Acknowledgement via pushbutton</p>
10	431 00	<p>Magnetic opening detector Surface-mounted magnetic detector 1 spring blade switch to be fixed on the door frame 1 moving magnet to be fixed on the door leaf</p>
1	408 98	<p>Electric door release Shunt trip door release 12 V~/= 6 W - 158 x 26 x 32 mm - 500 mA</p>
1	408 96	<p>Very short shunt trip door release (2-stage) 12 V=- - 200 mA For operation in double-entrance security doors Dimensions: 158 x 26 x 32 mm</p>
1	408 95	<p>Undervoltage door release 12 V=- - 600 mA For operation in emergency exits Dimensions: 158 x 26 x 32 mm</p>
1	767 09	<p>Motorised bolt Motorised bolt with manual internal unlocking Built-in position contact 12 V=- - 410 mA For surface-mounted installation</p>





Pack	Cat.Nos	Electromagnetic locks												
1	767 07	<p>Electromagnetic lock 300 kg Signalling of the leaf position via 2-colour LED and forwarding possible by changeover switch Control of the door position by Hall effect (not compatible with operation of the local emergency exit management unit Cat. No. 380 57) Consumption: 24 V 300 mA 7.2 W, 12 V 600 mA 7.2 W</p>												
1	767 08	<p>Electromagnetic lock 500 kg Signalling of the leaf position via 2-colour LED and forwarding possible by changeover switch Control of the door position by Hall effect (not compatible with operation of the local emergency exit management unit Cat. No. 380 57) Consumption: 24 V 250 mA 7.2 W, 12 V 500 mA 7.2 W</p>												
1	767 18	<p>Protected power supply 12 V power supply = - 4 A. Backed up by 12 V - 7 Ah battery Cat. No. 407 49 (not supplied)</p>												
1	047 95	<p>Filtered rectified power supply Comprising: - A safety transformer with interference filtering - A filter capacitor - Protection by PTC integrated in the primary - Double operating terminals PTC: Positive temperature coefficient. In the event of an automatic cut-off due to an overload or short circuit, switch off the power supply and allow it to cool down before switching on again.</p> <p>12 V=-</p> <table border="1"> <thead> <tr> <th rowspan="2">Power (W)</th> <th rowspan="2">Current (A)</th> <th colspan="2">Terminal capacity flexible cables (mm²)</th> <th rowspan="2">No. of modules</th> </tr> <tr> <th>input</th> <th>output</th> </tr> </thead> <tbody> <tr> <td>15</td> <td>1.3</td> <td>6</td> <td>6</td> <td>5</td> </tr> </tbody> </table>	Power (W)	Current (A)	Terminal capacity flexible cables (mm ²)		No. of modules	input	output	15	1.3	6	6	5
Power (W)	Current (A)	Terminal capacity flexible cables (mm ²)			No. of modules									
		input	output											
15	1.3	6	6	5										

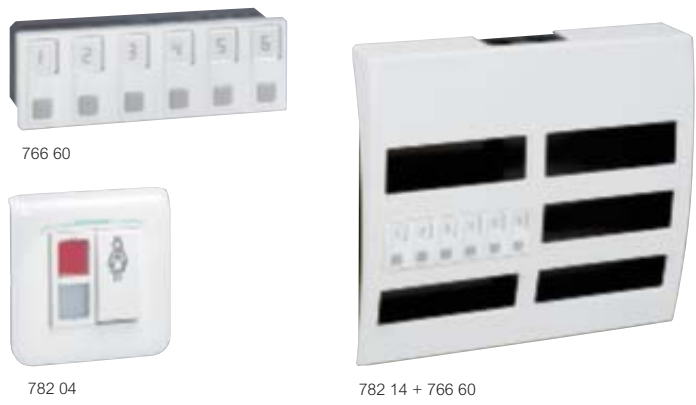

nurse call

for day hospitals, dialysis centres, etc.

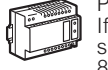

Designed for nurse call equipment in day hospitals, dialysis and transfusion centres, scanners, etc.
 Functions:
 • from the room: calls, emergency calls, nurse present indicator and call cancelling
 • from the nurses' station: patient reassurance
 Possibility of adding a paging system



Pack	Cat.Nos	Display units and management
1	766 60	6-direction call display unit  Registration of calls via numbered indicator lights and audible signal Several calls can be registered simultaneously Display of reassurance indicator and nurse present Possibility of transferring calls to 4 other display units (e.g.: treatment room, rest area, etc.) Installed: - in surface mounting box Cat. No. 802 86 - on table control unit Cat. No. 782 14 6 modules
1	782 14	Table control unit  Takes up to 6 display units Cat.No 766 60 Horizontal or vertical mounting Dim.: 310 x 295 x 75 mm 36 modules
1	782 89	24 V - 2 A - 48 W power supply  Powers the system If necessary, a 24 V protected power supply can be used 8 modules
1	782 12	3-direction management module  Manages 3 rooms (or directions) Possibility of forwarding via NO volt-free contact for indicator, audible signal, paging, master indicator 4 modules

Pack	Cat.Nos	Corridor and room equipment
1	766 72	Double display corridor overdoor light unit  Supplied with metal support for screw mounting and white finishing plate 2 modules Can be flush or surface mounted Fitted with long life LEDs Double indicator (red/white) Displays calls and nurse present in the corridor
1	782 04	Door unit  Includes 1 red indicator, 1 white indicator and 1 call and nurse presence cancel pushbutton. Antimicrobial

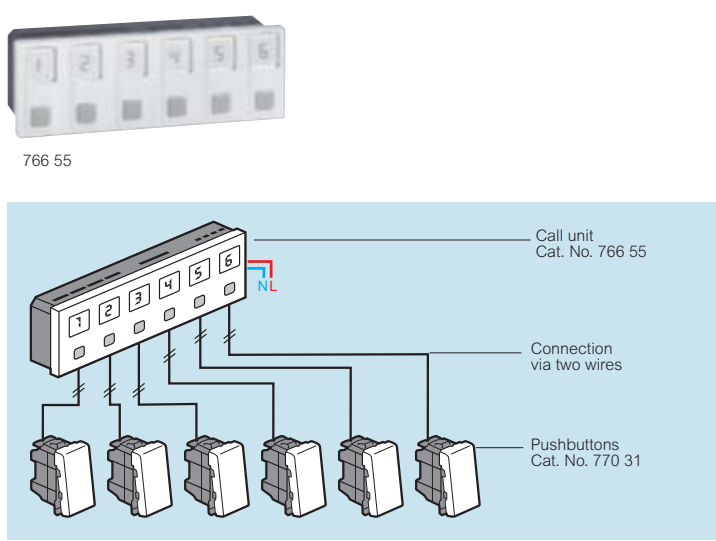
nurse call units



Suitable for hotels, teaching establishments, non-medical retirement homes
 For centralisation of 1 to 6 calls via indicator lights
 Call control via pushbutton
 2 wires per direction
 Registration of calls via numbered indicator lights and brief audible signal
 Several calls can be registered simultaneously
 Individual cancelling for each direction
 Supplied with numbers
 Possibility of using a 12 V protected supply for 12 V SELV units

Pack	Cat.Nos	Call units
1	766 55	6-direction modules Used to create call panels according to requirements 6 modules With integrated power supply 127/230 V~ - 50/60 Hz
1	766 57	For external 12 V SELV power supply (not provided)
1	766 56	6-direction transfer unit 6 directions For remote transfer of calls 6 modules
1	783 62	Components for call units  With 2 A NC contact Fitted with 2 m lead With 12 mm fixing centre plug for 2P socket Cat.No 771 50
1	771 50	Socket mechanism for biomedical calls  1 module Signals the end of a cycle via an alarm on the nurse call unit system For connecting portable electrical medical appliances such as syringe pumps, respirators, etc. 12 mm fixing centre ○ White antimicrobial

Mosaic™ functions, antimicrobial mechanism and plate selection chart

Controls

	Cat.Nos 783 75	2 A - 230 V two-way switch Switch with ejectable pull cord - 1 module White
	787 10	10 AX - 250 V two-way switch Two-way switch - 1 module White
	787 11	Two-way switch - 2 modules White
	787 12	LED indicator two-way switch 2 modules (modular) - White
	783 76	2 A - 230 V pushbutton Pushbutton with ejectable pull cord - 1 module White
	787 14	Pushbuttons 6 A - 250 V Pushbutton - 1 module White
	787 15	Pushbutton - 2 modules White
	787 16	LED indicator two-way pushbutton 2 modules (modular) - White
	770 43	Two-way pushbutton with label-holder - 2 modules White
	770 27	Ventilation control Ventilation control - 2 modules White
	766 66	Touch-sensitive switch Touch-sensitive switch, 10 AX - 2 modules White
	787 09	Touch controls Switch with neutral - 2 modules White
	787 13	Non-powered NO/NC contact switch 2 modules - White
	787 05	Roller shutter switch Roller shutter switch - 2 modules White

Mains voltage sockets

	787 01 771 16 771 17 771 18	2P+E sockets with automatic terminals 2P+E socket 2 modules - White 2P+E socket 2 modules - Green 2P+E socket 2 modules - Orange 2P+E socket 2 modules - Red
	771 32 771 33 787 04	2P+E sockets with flush recess 2P+E socket 2 modules - White 2P+E socket 2 modules - Red 2P+E socket 2 modules - Green
	771 31	Easy-insert 2P+E socket Easy-insert 2P+E socket - 5 modules White
	787 00	Equipotential socket Equipotential socket 2 modules White
	787 02 772 20	2P+E German standard sockets 2P+E socket 2 modules - White 2P+E socket 2 modules - Red
	772 19	2P+E socket with flap 2 modules - White
	771 50	2P ELV sockets 2P ELV socket 1 module - White
	770 80	Anti-extraction module Anti-extraction module 1 module - White
	771 12 771 15	2P+E sockets with screw terminals 2P+E socket with indicator - 2 modules - White 2P+E tamperproof socket with indicator - 2 modules Red

Low current sockets

	Cat.Nos 782 41	Magnetic connection socket for nurse call unit (call only) - 2 modules White
	782 45	Magnetic connection socket for nurse call unit (call, lighting, shutters) - 2 modules White
	765 83	RJ 45 socket, Cat. 6 shielded STP - 1 module White
	765 82	RJ 45 socket, Cat. 6 shielded FTP - 1 module White
	765 81	RJ 45 socket, Cat. 6 shielded UTP - 1 module White

Signage

	785 10	0.2 or 1 W illuminated sign 2 modules White
--	--------	---

Blanking plates

	787 20	Blanking plate 1 module - White
	787 21	Blanking plate 2 modules - White

Plates

	787 22	2 modules Plate 2 modules - White
	788 80	Plate 2 modules IP 44 - White
	787 24	4 modules Plate 4 modules horizontal - White
	787 25	Horizontal 2 x 2 modules Plate 2 x 2 modules horizontal - White
	787 23	Vertical 2 x 2 modules Plate 2 x 2 modules vertical - White
	787 26	6 horizontal modules Plate 6 modules horizontal - White

Complete mechanisms (mechanism + support + plate)

	782 48	Call pull cord Bathroom call pull cord IP 55, ejectable 2 modules - White
	766 85	LED call unit Call unit with red indicator 2 modules - White
	782 04	Door unit Door unit with red indicator, white indicator and a call and nurse presence cancel pushbutton
	784 90	Automatic detector BUS/SCS automatic detector 2 modules - White
	782 46	Magnetic connection sockets Socket for call only hand-held remote control unit 2 modules - White
	782 47	Socket for call, lighting and shutter hand-held remote control unit 2 modules - White

reminder of current standards

■ Bedhead strips:

Self-extinguishing test

The test report related to compliance with the fire safety regulations is completed by an independent organisation

It involves a self-extinguishing test following application of an incandescent wire to the luminaire

The luminaire is qualified in accordance with the temperature of the wire applied and the time taken for the flame to extinguish: 850° and 30 seconds maximum are the qualification criteria for public buildings

CE marking

CE marking is a mandatory marking for luminaires

It is a declaration from the manufacturer itself which commits its signatory alone. There is no verification by external organisations

It is based on specific directives and standards which govern the manufacture of luminaires from the point of view of safety and electromagnetic compatibility

For electrical safety it involves standard EN 60 598 known as the Luminaire Standard

It ensures that the assemblies are electrically compliant and in a broader sense ensures all electrical safety aspects for the user Standard EN 60 598-2-25 is specific to luminaires in hospitals and health establishments

In terms of electromagnetic compatibility several standards provide a reference for luminaires

The aim is to ensure that the luminaire in operation is not going to disrupt other electrical and/or electronic devices such as televisions, alarms and indeed pacemakers

Conversely it must be ensured that these electrical or electronic devices do not disrupt the operation of the luminaires (for example their switching on):

- EN 12464-1 and NFX 90-003-1 standards on luminaires and the lighting of indoor workplaces

- EN 61547 CE standard on luminaire immunity

- EN 55015 CE standard on luminaire radiation

- EN 61000-3-2 CE standard on luminaire harmonics

Trunking for medical gases

Extract of standard FD S 90_155 on distribution systems for medical gases: where so-called "bedhead" medical gases are installed (see EN ISO 11197 on service ducts) or fixed mast arms (or ceiling columns) fitted in particular with sockets for medical gases, it is recommended that the same manufacturer is used for the distribution system and for the busbar systems inside the trunking, including the medical gas sockets integrated into the supplies provided

■ BUS/SCS nurse call unit

Complies with the VDE standard on call systems for hospitals, nursing homes and similar establishments:

- DIN VDE 0834-1 instructions for equipment, its installation and operation

- DIN VDE 0834-2 environmental conditions and electromagnetic compatibility

The indicators associated with the hospital signalling conform with the general standard EN 60 073 which provides the colour coding principles

conversion table

Cat.Nos old range	Cat.Nos new range	Description
Lighting strips and controls		
783 18	783 32	LED bedhead strips, 8 modules, extendable, reading + room lighting, antimicrobial
783 18	783 38	LED/Fluorescent bedhead strips, 8 modules, extendable, reading + room lighting, antimicrobial
783 17	783 45	Fluorescent T5 bedhead strip, 8 modules, extendable, reading + room lighting
783 90	783 77	230 V~ remote control module for lighting or other SELV functions
766 67	783 75	Two-way switch with ejectable pull cord, 1 module, antimicrobial
Pushbutton cord and sockets		
781 03 / 783 62	782 40	Ejectable call only hand-held remote control unit (pushbutton cord) Works with 2-module sockets Cat. No. 782 41/46
771 50	782 41	2-module socket mechanism for call only hand-held remote control unit, ejectable, magnetic connection Works with call only remote control unit Cat. No. 782 40
766 63	782 46	2-module complete plug for ejectable hand-held remote control unit with magnetic connection Works with call only remote control unit Cat. No. 782 40
Ejectable hand-held remote control units and sockets		
783 67/69	782 42	Call and lighting control hand-held remote control unit (3 functions), ejectable Works with sockets Cat. No. 782 45/47
783 66	782 44	Call, lighting and roller shutter control hand-held remote control unit (6 functions), ejectable Works with sockets Cat. No. 782 45/47
766 68	782 45	2-module socket mechanism for 3 or 6 function hand-held remote control unit, ejectable, with magnetic connection Works with hand-held remote control units Cat. No. 782 42/44
766 68	782 47	Complete socket for 3 or 6 function hand-held remote control unit, ejectable, with magnetic connection Works with hand-held remote control units Cat. No. 782 42/44
766 65	782 45/47	2-module socket mechanism for 3 or 6 function hand-held remote control unit, ejectable, with magnetic connection Works with hand-held remote control unit Cat. No. 782 42
Bathroom call		
766 64	782 48	Waterproof bathroom call pull cord, ejectable, antimicrobial



**World Headquarters
and International Department**
87045 Limoges Cedex - France

☎: + 33 (0) 5 55 06 87 87

Fax: + 33 (0) 5 55 06 88 88

www.legrand.com