

SALBEI™

&

SALBEI™
selection

DAHA RENKLİ,
DAHA HESAPLI,
ÜSTELİK LEGRAND.



BİNA ELEKTRİK VE DİJİTAL ALTYAPILARI İÇİN
ÜRÜN VE SİSTEMLER

 **legrand**

İçindekiler

1-20		
Genel özellikler	Yeni Salbei'nin yaratım öyküsü	2
	Salbei <small>selection</small> renkler&tasarım	4
	Salbei mekanizmalar	6
	Salbei <small>selection</small> mekanizmalar	8
	Salbei üstünlükler/avantajlar	10
	Salbei/Salbei <small>selection</small> seçim tablosu	20
22-28		
Katalog sayfaları	Salbei katalog sayfaları	22
	Salbei çerçeveler	24
	Salbei <small>selection</small> katalog sayfaları	25
	Salbei <small>selection</small> çerçeveler	28
29-44		
Teknik özellikler	Salbei mekanizma teknik özellikler	29
	Salbei / Salbei <small>selection</small> çerçeve boyutları	44

SALBEİ™ SELECTION



AHSAP



KOYU AHSAP



İNCİ BEYAZI



ALTIN



FÜME

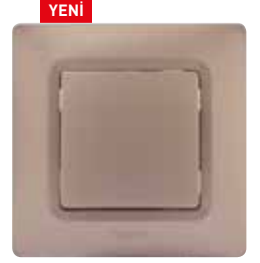

ROZE

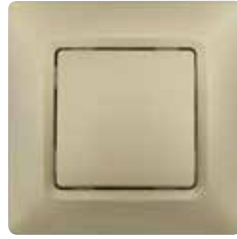

ŞAMPANYA



ALÜMİNYUM



ANTRASİT

SALBEİ™



BEYAZ



BEJ

YENİ SALBEİ™'NİN
YARATIM ÖYKÜSÜ

AYNI HARİKA TASARIM, YEPYENİ RENKLER, FONKSİYONLAR.

Sizi dinledik,
teknolojiden
ilham aldık.

Yeni SALBEİ™ sadece masa başında tasarlanmadı. Aylar süren şantiye ziyaretleri, elektrik profesyonellerinden alınan yorumlar ve yoğun AR-GE çalışmaları yeni SALBEİ™'nin yaratılmasında önemli rol oynadı.

Yenilenen renkleri, işlevleri ve gelişmiş montaj özelliklerini yakından tanıyınca bize hak vereceksiniz.



YENİ SALBEİ™'NİN
YARATIM ÖYKÜSÜ

SALBEI™ SELECTION



KOYU AHŞAP + ALÜMİNYUM ANAHTAR



FÜME + ROSE TOPRAKLI PRİZ



FÜME + İNCİ BEYAZI KOMÜTATÖR



AHŞAP + BEJ PANJUR ANAHTARI



ROSE + İNCİ BEYAZI PANJUR ANAHTARI



İNCİ BEYAZI + FÜME TV /SAT PRİZİ



ALTIN + FÜME RJ11 PRİZ



ALÜMİNYUM + ANTRASİT ANAHTAR

SALBEI™
SELECTION

RENKLER &
TASARIM

SEÇİN, BİRLEŞTİRİN, KEŞFEDİN.

Farklı bir
tarzınız mı var?
Salbei'nin de.

Konu, farklı yaşam ortamlarına uyuma geldiğinde, SALBEI™ ve SALBEI™^{selection} yeteneklerini ortaya koyuyor. Klasik oymalı mobilyalardan modern köşe takımları ve TV gruplarına kadar tüm seçim ve zevklere aynı anda sesleniyor.

Açık ya da koyu, metal veya ahşap...
Tüm beklentilere yanıtınız SALBEI™.



SALBEI™^{selection}
RENKLER & TASARIM

KUMANDA MEKANİZMALARI



ANAHTAR



VAVİEN



KOMÜTATÖR



KOMÜTATÖR VAVİEN



ÜÇLÜ ANAHTAR



PERMÜTATÖR



LİHT BUTONU



KOMÜTATÖR LİHT



PANJUR /
STOR ANAHTARI



YENİ
PANJUR / STOR
LİHT BUTONU



ÇEVİRMELİ DİMMER
400 W



YENİ
LED DİMMER

Tüm kumanda mekanizmaları 797199 referanslı LED ile ışıklı hale getirilebilir.

PRİZLER



TOPRAKLI PRİZ



ÇOCUK KORUMALI
TOPRAKLI PRİZ



FRANSIZ STANDARTI
ÇOCUK KORUMALI
TOPRAKLI PRİZ, UPS



FRANSIZ STANDARTI
ÇOCUK KORUMALI
TOPRAKLI PRİZ, UPS,
KIRMIZI KAPAK



KAPAKLI ÇOCUK
KORUMALI TOPRAKLI
PRİZ



İKİLİ TOPRAKLI PRİZ

TV PRİZLERİ



YENİ
TV PRİZİ, YILDIZ
BAĞLANTI, 1,5 DB



TV PRİZİ, GEÇİŞLİ,
14 DB



TV PRİZİ, SONLU,
10 DB



TV PRİZİ, F TİPİ



TV-SAT PRİZ,
SONLU, 10 DB



YENİ
TV-SAT PRİZ, YILDIZ
BAĞLANTI, 1,5 DB



TV-SAT PRİZ, GEÇİŞLİ,
14 DB

SALBEI™

TELEFON VE DATA PRİZLERİ



RJ11, 1 ÇIKIŞ



RJ11, 2 ÇIKIŞ



RJ45 CAT 5E UTP,
1 ÇIKIŞ



RJ45 CAT 6 UTP,
1 ÇIKIŞ



RJ45 CAT 6 UTP,
2 ÇIKIŞ



RJ11 + RJ45
CAT 6 UTP

DİĞER ÜRÜNLER



ENERGY SAVER



BOŞLUK KAPAĞI

AKSESUARLAR



TEKLİ SIVA ÜSTÜ
KASA

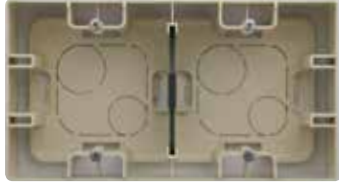

İKİLİ SIVA ÜSTÜ KASA

YENİ



ETİKET TAŞIYICILI
ÇERÇEVE

Her ihtiyaca
bir işlev.

Sadece Bej ve Beyaz renklerde sunulan SALBEİ™, her boyuttaki proje için tek seri ile eksiksiz bir işlev dünyası sunuyor.

KUMANDA MEKANİZMALARI



ANAHTAR



VAVİEN

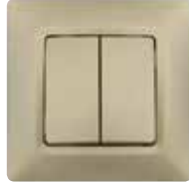

KOMÜTATÖR



KOMÜTATÖR VAVİEN



ÜÇLÜ ANAHTAR



PERMÜTATÖR



LİHT BUTONU



KOMÜTATÖR LİHT



PANJUR /
STOR ANAHTARI



PANJUR / STOR
LİHT BUTONU



ÇEVİRMELİ DİMMER
400 W



LED DİMMER

İŞIKLI KUMANDA MEKANİZMALARI



İŞIKLI ANAHTAR



İŞIKLI VAVİEN



İŞIKLI LİHT BUTONU

PRİZLER



TOPRAKLI PRİZ



ÇOCUK KORUMALI
TOPRAKLI PRİZ



FRANSIZ STANDARTI
ÇOCUK KORUMALI
TOPRAKLI PRİZ, UPS



KAPAKLI ÇOCUK
KORUMALI TOPRAKLI
PRİZ



İKİLİ TOPRAKLI PRİZ

DİĞER ÜRÜNLER



ENERGY SAVER



BOŞLUK KAPAĞI

SALBEI™
SELECTION

TV PRİZLERİ

YENİ



TV PRİZİ, YILDIZ BAĞLANTI, 1,5 DB



TV PRİZİ, GEÇİŞLİ, 14 DB



TV PRİZİ, SONLU, 10 DB



TV PRİZİ, F TİPİ

YENİ



TV-SAT PRİZ, YILDIZ BAĞLANTI, 1,5 DB



TV-SAT PRİZ, GEÇİŞLİ, 14 DB



TV-SAT PRİZ, SONLU, 10 DB

TELEFON VE DATA PRİZLERİ



RJ11, 1 ÇIKIŞ



RJ11, 2 ÇIKIŞ



RJ45 CAT 5E UTP, 1 ÇIKIŞ



RJ45 CAT 6 UTP, 1 ÇIKIŞ



RJ45 CAT 6 UTP, 2 ÇIKIŞ



RJ11 + RJ45 CAT 6 UTP

AKSESUARLAR

YENİ



TEKLİ SIVA ÜSTÜ KASA

YENİ



İKİLİ SIVA ÜSTÜ KASA

Daha çok renk,
daha kullanışlı
çözümler.

SALBEI™ selection'da tüm işlevleri İnci Beyazı, Roze, Altın, Şampanya, Alüminyum, Füme ve Antrasit renklerinde bulabilirsiniz.

Üstelik tüm mekanizmaların montajı artık daha da kolay.

YENİ NESİL İZOLE KAİDE. EMNİYETLİ MONTAJ VE KULLANIM.

Alev iletmez,
zehirli duman
çıkarmaz,
paslanmaz.
Montajı ise
hem kolay,
hem güvenli.

SALBEI™ mekanizmaları
yeni nesil izole kaidenin
sunduğu izole yapı sayesinde
montaj sırasında elektrik
çarpmalarına karşı tam
güvenlik sunar.

HALOGEN
FREE

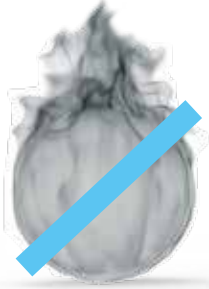

ZEHİRLİ MADDE
İÇERMEZ



ALE V
İLETMEZ



ELEKTİK AKIMI
İLETMEZ



PASLANMAZ

SALBEI™
ÜSTÜNLÜKLER & AVANTAJLAR

*Çalışan parçaları tutan yalıtkan parçalar için: +850°C/30sn içinde sönme.
Yalıtkan malzemeden yapılan diğer parçalar için: +650°C/30sn içinde sönme.

DAHA SESSİZ ve GÜVENİLİR OLMAK İÇİN ÖYLE GÜZEL NEDENLERİMİZ VAR Kİ.

Uyum ve
konfor
bir arada.

Legrand kalitesini kolaylıkla hissedeceğiniz sessiz çalışma özelliği, 3 boyutlu bilgisayar simülasyonlarıyla geliştirilen anahtar mekanizmalarının sağladığı üstünlüklerden sadece biri.



SALBEI™
ÜSTÜNLÜKLER & AVANTAJLAR

HER ŐEY SİZE ZAMAN KAZANDIRMAK İÇİN.

SALBEİ™, yenilenen pürüzsüz yeni nesil izole kadesiyle daha sağlam ve dayanıklı.

Güncellenen mekanizma tasarımı ve vida yuvalarıyla şarjlı tornavida kullanımı daha kolay.

Boyutları daha da küçülen mekanizmalar her türlü buata mükemmel uyum sağlıyor.



Çoklu uygulamalar için yedek bağlantı noktaları

Vida bağlantılı prizler

Kumanda mekanizmaları otomatik kablo bağlantıları

LED ışıklandırma yuvaları

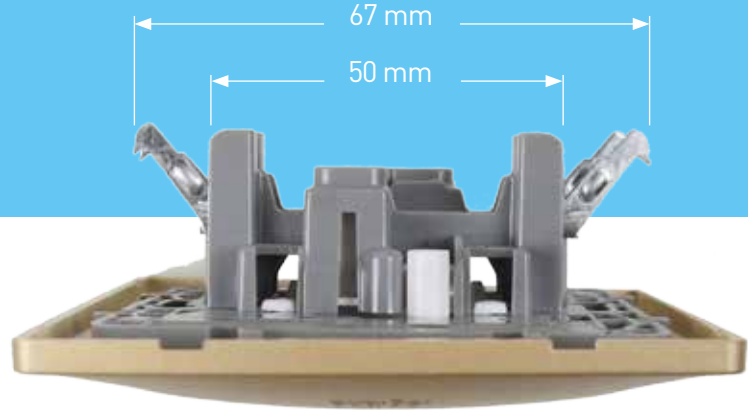

SALBEİ™ MEKANİZMALARI
ÜSTÜNLÜKLER & AVANTAJLAR



HALOGEN
FREE

2 KAT
GÜÇLÜ
TUTUNMA

Yapılan testler sonucu, SALBEI™ mekanizma tırnaklarının en yakın rakibinden 2 kat daha güçlü tutunma sağladığı tespit edilmiştir.

SALBEI™'Yİ SİZ YARATTINIZ, BİZ SADECE ÜRETTİK.

Daha küçük mekanizma, geniş açılan güçlü tırnaklar, otomatik kablo bağlantıları.

Montajı kolaylaştıran ve size zaman kazandıran birçok yenilik SALBEI™'de bir arada.

Pürüzlü yüzeylerde bile duvara tam oturan dayanıklı yeni nesil izole kaide, tek tık'la yerine oturan vidasız tuş kapağı, özel kanalların içinde çalışan süper güçlü tırnaklar..

Tüm bu kolaylıkları siz istediniz, Legrand üretti.

SALBEI™
ÜSTÜNLÜKLER & AVANTAJLAR

KOLAYLIKLAR PEŞ PEŞE GELİYOR.

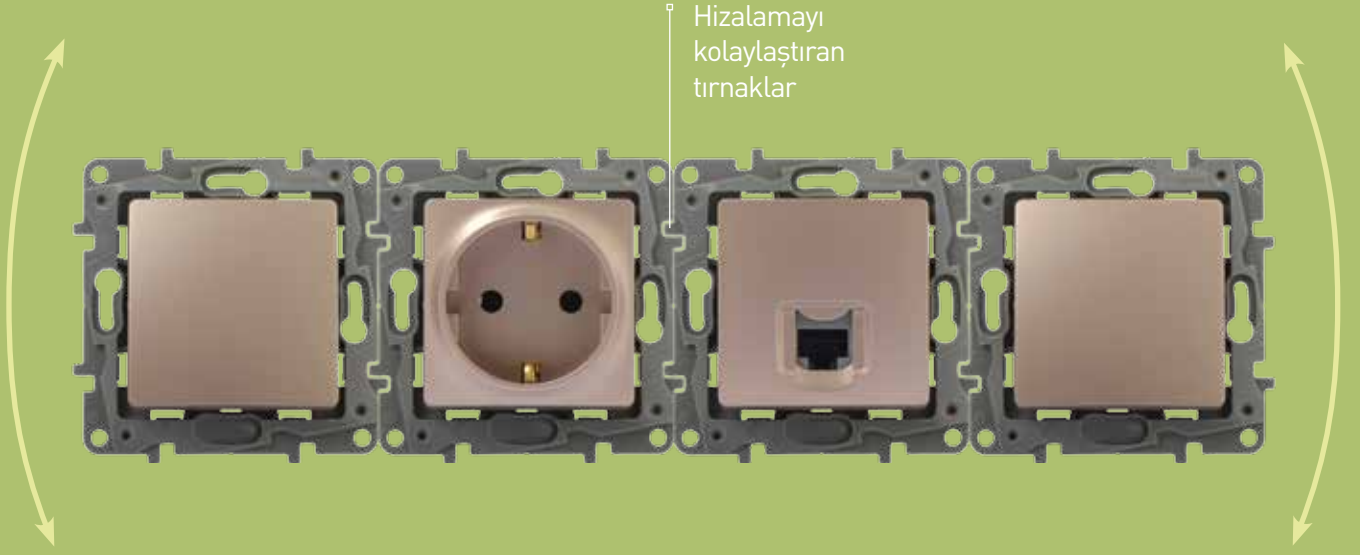

SALBEİ™ MEKANİZMALARI
ÜSTÜNLÜKLER & AVANTAJLAR





KOLAY VE PRATİK
MONTAJ

HİZALAYIN, MONTE EDİN. TEK HAREKETLE.

Özel hizalama
çıkıntılarıyla
kusursuz montaj
garantisi.

Yeni nesil izole kaide üzerinde, 2'li, 3'lü, 4'lü ve 5'li kurulumlarda hizalamayı kolaylaştıran girinti ve çıkıntılar bulunur. İlk mekanizma doğru yerleştiğinde diğer mekanizmalar yeni nesil kaide üzerindeki geçmeli sistem sayesinde, kolaylıkla aynı hizada monte edilebilir.



SALBEI™
ÜSTÜNLÜKLER & AVANTAJLAR

NEREDESİN SALBEİ?



BURADAYIM.

SALBEİ™ serisindeki tüm Bej ve Beyaz kumanda mekanizmaları SALBEİ™ LED kullanarak ışıklı hale getirebilirsiniz.

Yeni ürün almaya gerek yok, farklı referans yok.
Montajı kolay, stoklanması kolay.



SALBEİ™ MEKANİZMALARI
ÜSTÜNLÜKLER & AVANTAJLAR



EVLERİ, OFİSLERİ LED'LENDİRİN, DİMLEYİN.

SALBEİ™
kontrolü size
veriyor.

LED teknolojisi enerji tasarrufu sağlıyor ve yaygınlaştıkça kullanım alanları çeşitleniyor. 300 W'a kadar LED aydınlatmalarınızı SALBEİ™ LED Dimmerler ile kontrol edin. Hem tasarrufu artırın, hem şıklığı.



SALBEİ™
ÜSTÜNLÜKLER & AVANTAJLAR

MONTAJ SIRASINDA: ÖNCE MEKANİZMA, SONRA TUŞ KAPAĞI, EN SON ÇERÇEVE.

Özellikle çoklu kurulumlarda SALBEİ™ mekanizmaların montajı yapılırken önce tuş kapağı sonra çerçeve takılmasına dikkat edilmelidir. Böylece çerçeve çok daha kolay ve sağlam monte edilebilir.

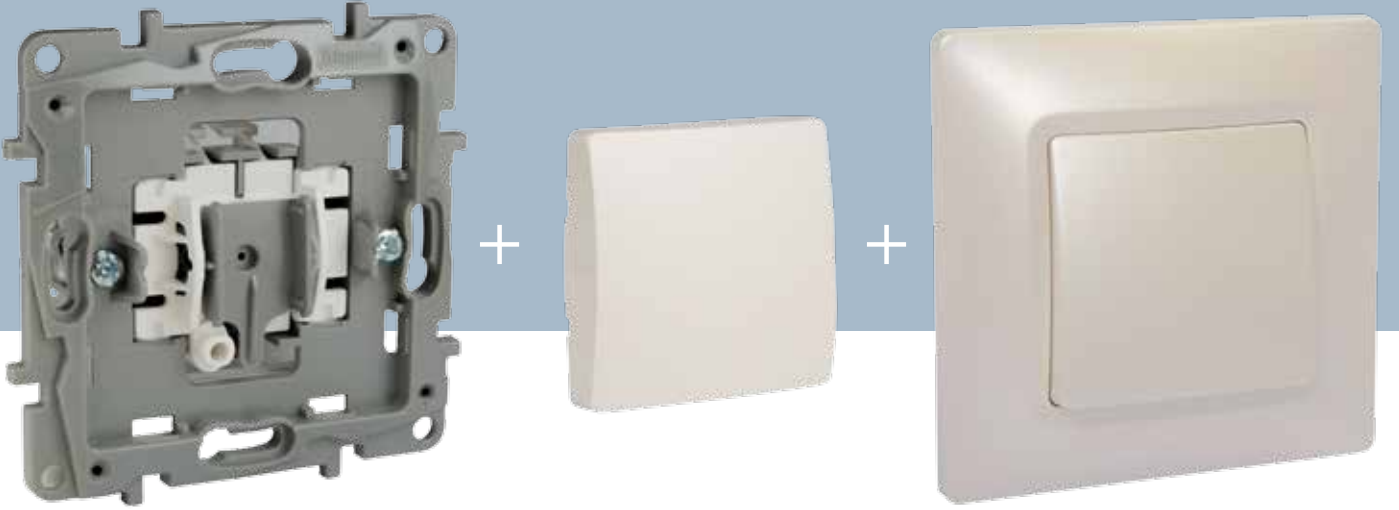

SALBEİ™ MEKANİZMALARI
ÜSTÜNLÜKLER & AVANTAJLAR

PRİZLERE KOLAYLIK GELDİ.

Vidasız tuş
kapakları,
mekanik bağlantı
harikaları

SALBEİ™ data prizleri, üzerindeki EIA/TIA 568-C.2 Standardı'na uyumlu işaretleme sistemi ile kolay kablolama sağlar. Aynı zamanda kilitleme mekanizması ve yerinden çıkabilen keystone'lar gibi özellikleri sayesinde pratik montaj sunar.

SALBEİ™'de priz montajları vidalı tuş kapağı sayesinde çok daha pratik ve kolaydır.



Data prizi montajı



KOLAY VE PRATİK
MONTAJ



Priz montajı

























TV Prizi montajı
artık böyle bir şey.

TV priz kablo bağlantılarında klipsli mekanizma ile pratik ve güvenli montaj.



SALBEİ™
ÜSTÜNLÜKLER & AVANTAJLAR

Seçim tablosu

İŞLEVLER		Salbei™		Salbei™ selection						
		Beyaz	Bej	Alüminyum	Antrasit	Şampanya	Altın	Roze	Füme	İnci Beyazı
Kumanda Mekanizmaları										
Anahtar, 10 AX - 250 V~		7 671 00	7 674 00	7 672 00	7 673 00	7 675 00	7 676 00	7 677 00	7 678 00	7 679 00
Vavien, 10 AX - 250 V~		7 671 01	7 674 01	7 672 01	7 673 01	7 675 01	7 676 01	7 677 01	7 678 01	7 679 01
Komütatör, 10 AX - 250 V~		7 671 06	7 674 06	7 672 06	7 673 06	7 675 06	7 676 06	7 677 06	7 678 06	7 679 06
Komütatör Vavien, 10 AX - 250 V~		7 671 02	7 674 02	7 672 02	7 673 02	7 675 02	7 676 02	7 677 02	7 678 02	7 679 02
Üçlü Anahtar, 10 AX - 250 V~		7 671 03	7 674 03	7 672 03	7 673 03	7 675 03	7 676 03	7 677 03	7 678 03	7 679 03
Permütatör, 10 AX - 250 V~		7 671 04	7 674 04	7 672 04	7 673 04	7 675 04	7 676 04	7 677 04	7 678 04	7 679 04
Liht Butonu, 10 AX - 250 V~		7 671 05	7 674 05	7 672 05	7 673 05	7 675 05	7 676 05	7 677 05	7 678 05	7 679 05
Komütatör Liht Butonu, 10 AX - 250 V~		7 671 68	7 674 68	7 672 68	7 673 68	7 675 68	7 676 68	7 677 68	7 678 68	7 679 68
Panjur-Stor Anahtarı		7 671 09	7 674 09	7 672 09	7 673 09	7 675 09	7 676 09	7 677 09	7 678 09	7 679 09
Panjur-Stor Liht Butonu		7 671 69	7 674 69	7 672 69	7 673 69	7 675 69	7 676 69	7 677 69	7 678 69	7 679 69
Işıklı Kumanda Mekanizmaları										
Işıklı Anahtar		*	*	7 672 66	7 673 66	7 675 66	7 676 66	7 677 66	7 678 66	7 679 66
Işıklı Vavien		*	*	7 672 08	7 673 08	7 675 08	7 676 08	7 677 08	7 678 08	7 679 08
Işıklı Liht Butonu		*	*	7 672 67	7 673 67	7 675 67	7 676 67	7 677 67	7 678 67	7 679 67
Dimmerler										
Çevirmeli Dimmer 400 W		7 671 10	7 674 10	7 672 10	7 673 10	7 675 10	7 676 10	7 677 10	7 678 10	7 679 10
LED Çevirmeli Dimmer 300 W		7 671 12	7 674 12	7 672 12	7 673 12	7 675 12	7 676 12	7 677 12	7 678 12	7 679 12
Energy Saver										
Energy Saver		7 671 11	7 674 11	7 672 11	7 673 11	7 675 11	7 676 11	7 677 11	7 678 11	7 679 11
Topraklı Prizler										
Topraklı Priz		7 671 14	7 674 14	7 672 14	7 673 14	7 675 14	7 676 14	7 677 14	7 678 14	7 679 14
Çocuk Korumalı Topraklı Priz		7 671 15	7 674 15	7 672 15	7 673 15	7 675 15	7 676 15	7 677 15	7 678 15	7 679 15
İkili Topraklı Priz		7 671 16	7 674 16	7 672 16	7 673 16	7 675 16	7 676 16	7 677 16	7 678 16	7 679 16
Fransız Standardı Çocuk Korumalı Topraklı Priz, UPS		7 671 17	7 674 17	7 672 17	7 673 17	7 675 17	7 676 17	7 677 17	7 678 17	7 679 17
Fransız Standardı Çocuk Korumalı Topraklı Priz, UPS, kırmızı		7 671 19**	-	-	-	-	-	-	-	-
Kapaklı Çocuk Korumalı Topraklı Priz		7 671 18	7 674 18	7 672 18	7 673 18	7 675 18	7 676 18	7 677 18	7 678 18	7 679 18

İŞLEVLER	Salbei™		Salbei™ _{selection}							
	Beyaz	Bej	Alüminyum	Antrasit	Şampanya	Altın	Roze	Füme	İnci Beyazı	
TV Prizleri										
TV prizi, geçişli 14 dB		7 671 23	7 674 23	7 672 23	7 673 23	7 675 23	7 676 23	7 677 23	7 678 23	7 679 23
TV prizi, sonlu 10 dB		7 671 26	7 674 26	7 672 26	7 673 26	7 675 26	7 676 26	7 677 26	7 678 26	7 679 26
TV prizi, yıldız bağlantı, 1,5 dB		7 671 57	7 674 57	7 672 57	7 673 57	7 675 57	7 676 57	7 677 57	7 678 57	7 679 57
TV prizi, F tipi		7 671 25	7 674 25	7 672 25	7 673 25	7 675 25	7 676 25	7 677 25	7 678 25	7 679 25
TV-SAT prizi, geçişli 14 dB		7 671 27	7 674 27	7 672 27	7 673 27	7 675 27	7 676 27	7 677 27	7 678 27	7 679 27
TV-SAT prizi, sonlu 10 dB		7 671 28	7 674 28	7 672 28	7 673 28	7 675 28	7 676 28	7 677 28	7 678 28	7 679 28
TV-SAT prizi, yıldız bağlantı		7 671 58	7 674 58	7 672 58	7 673 58	7 675 58	7 676 58	7 677 58	7 678 58	7 679 58
TV-SAT-SAT priz		7 671 59	7 674 59	7 672 59	7 673 59	7 675 59	7 676 59	7 677 59	7 678 59	7 679 59
Telefon ve Data Prizleri										
RJ11 , 1 çıkış		7 671 29	7 674 29	7 672 29	7 673 29	7 675 29	7 676 29	7 677 29	7 678 29	7 679 29
RJ11 , 2 çıkış		7 671 30	7 674 30	7 672 30	7 673 30	7 675 30	7 676 30	7 677 30	7 678 30	7 679 30
RJ45 priz cat 5e UTP		7 671 38	7 674 38	7 672 38	7 673 38	7 675 38	7 676 38	7 677 38	7 678 38	7 679 38
RJ45 priz cat 6 UTP		7 671 39	7 674 39	7 672 39	7 673 39	7 675 39	7 676 39	7 677 39	7 678 39	7 679 39
2 x RJ45 priz cat 6 UTP		7 671 40	7 674 40	7 672 40	7 673 40	7 675 40	7 676 40	7 677 40	7 678 40	7 679 40
RJ11 + RJ45 cat 6 UTP		7 671 37	7 674 37	7 672 37	7 673 37	7 675 37	7 676 37	7 677 37	7 678 37	7 679 37
Diğer Ürünler										
Kablo Çıkışı		7 671 20	7 674 20	7 672 20	7 673 20	7 675 20	7 676 20	7 677 20	7 678 20	7 679 20
Boşluk Kapağı		7 671 21	7 674 21	7 672 21	7 673 21	7 675 21	7 676 21	7 677 21	7 678 21	7 679 21
LED Lamba		7 671 99								
Sıva Üstü Kasa		7 671 47	7 674 47	7 672 47	7 673 47	7 675 47	7 676 47	7 677 47	7 678 47	7 679 47
İkili Sıva Üstü Kasa		7 671 48	7 674 48	7 672 48	7 673 48	7 675 48	7 676 48	7 677 48	7 678 48	7 679 48

ÇERÇEVELER	Salbei™		Salbei™ _{selection}								
	Beyaz	Bej	Alüminyum	Antrasit	Şampanya	İnci Beyazı	Füme	Altın	Roze	Ahşap	Koyu Ahşap
Tekli Çerçeve	7 673 31	7 673 41	7 673 51	7 673 61	7 673 71	7 675 41	7 675 51	7 675 61	7 675 71	7 673 81	7 675 31
2'li çerçeve	7 673 32	7 673 42	7 673 52	7 673 61	7 673 72	7 675 42	7 675 52	7 675 62	7 675 72	7 673 82	7 675 32
3'lü çerçeve	7 673 33	7 673 43	7 673 53	7 673 61	7 673 73	7 675 43	7 675 53	7 675 63	7 675 73	7 673 83	7 675 33
4'lü çerçeve	7 373 34	7 373 44	7 373 54	7 673 61	7 373 74	7 675 44	7 675 54	7 675 64	7 675 74	7 673 84	7 675 34
5'li çerçeve	7 673 35	7 673 45	7 673 55	7 673 61	7 673 75	7 675 45	7 675 55	7 675 65	7 675 75	7 673 85	7 675 35
Etiket Taşıyıcılı Çerçeve	7 671 90	7 674 90	7 672 90	7 673 90	7 675 90	7 679 90	7 678 90	7 676 90	7 677 90		



7 671 00 + 7 673 31



7 671 03 + 7 673 31



7 671 10 + 7 673 31



7 671 11 + 7 673 31

Mekanizmalar tuş kapağı ile birlikte temin edilir ve tekli ya da çoklu çerçeveler ile tamamlanır. Sıva altı veya üstü kasalara tırnaklı veya vidalı montaj.
Halojen free (Halojen içermez) mekanizma ve kaide
Ultraviyole ışınlarına dayanıklı
Kendiliğinden sönmeye:

- çalışan parçaları yerinde tutan yalıtkan parçalar için: + 850° C / 30 s.
- yalıtkan malzemeden yapılan diğer parçalar için: + 650° C / 30 s.

Amb.	Ref.	Kumanda mekanizmaları
12	7 671 00	Anahtar, 10 AX - 250 V~
12	7 674 00	○ Beyaz ● Bej
12	7 671 01	Vavien, 10 AX - 250 V~
12	7 674 01	○ Beyaz ● Bej
12	7 671 06	Komütatör, 10 AX - 250 V~
12	7 674 06	○ Beyaz ● Bej
12	7 671 02	Komütatör Vavien, 10 AX - 250 V~
12	7 674 02	○ Beyaz ● Bej
12	7 671 03	Üçlü anahtar, 10 AX - 250 V~
12	7 674 03	○ Beyaz ● Bej
12	7 671 04	Permütatör, 10 AX - 250 V~
12	7 674 04	Vavien kurulumuna eklenerek üçüncü bir kontrol noktasını mümkün kılar. ○ Beyaz ● Bej
12	7 671 05	Liht butonu, 6A - 250 V~
12	7 674 05	○ Beyaz ● Bej
12	7 671 68	Komütatör liht butonu
12	7 674 68	○ Beyaz ● Bej
12	7 671 09	Panjur-Stor anahtarı, 6 AX - 250 V~
12	7 674 09	Motorun direkt kontrolü için 3 seviye: yukarı-dur-aşağı ○ Beyaz ● Bej
12	7 671 69	Panjur-Stor liht butonu
12	7 674 69	○ Beyaz ● Bej

Amb.	Ref.	Dimmer
1	7 671 10	Standart anahtar mekanizmasının yerine monte edilebilir.
1	7 674 10	Sınırsız dönebilen düğme. Çevrilebilir düğme ortasından ON/OFF yapabilme özelliği.
1	7 671 12	Çevirmeli dimmer 400 W
1	7 674 12	○ Beyaz ● Bej
1	7 671 11	Çevirmeli dimmer 300 W RLC+LED
1	7 674 11	○ Beyaz ● Bej
1	7 671 11	Energy saver
1	7 674 11	30 sn. gecikmeli Energy saver ○ Beyaz ● Bej
12	7 671 99	LED lamba
		LED lamba Tüm bej ve beyaz kumanda mekanizmaları LED lamba kullanılarak ışıklı hale getirilebilir.

Salbei™

Prizler



7 674 14 + 7 673 41



7 671 17 + 7 673 31

Salbei™

TV prizleri



7 671 28 + 7 673 31



7 674 24 + 7 673 41

Mekanizmalar tuş kapağı ile birlikte temin edilir ve tekli ya da çoklu çerçeveler ile tamamlanır. Sıva altı veya üstü kasalara tırnaklı veya vidalı montaj.
Halojen free (Halojen içermez) mekanizma ve kaide
Ultraviyole ışınlarına dayanıklı
Kendiliğinden sönmeye:

- çalışan parçaları yerinde tutan yalıtkan parçalar için: + 850° C / 30 s.
- yalıtkan malzemeden yapılan diğer parçalar için: + 650° C / 30 s.

Amb.	Ref.	Prizler
12	7 671 14	Topraklı priz ○ Beyaz ● Bej
12	7 674 14	
12	7 671 15	Çocuk korumalı topraklı priz ○ Beyaz ● Bej
12	7 674 15	
10	7 671 16	İkili topraklı priz 2 modül buata montaj yapılır. Komple temin edilir. ○ Beyaz ● Bej
10	7 674 16	
12	7 671 17	Fransız standardı çocuk korumalı topraklı priz, UPS ○ Beyaz ● Bej ● Kırmızı
12	7 674 17	
12	7 671 19	
10	7 671 18	Kapaklı çocuk korumalı topraklı priz ○ Beyaz ● Bej
10	7 674 18	

Amb.	Ref.	TV prizleri
12	7 671 23	TV prizi geçişli 14dB ○ Beyaz ● Bej
12	7 674 23	
12	7 671 26	TV prizi geçişli sonlu 10dB ○ Beyaz ● Bej
12	7 674 26	
12	7 671 57	TV prizi, yıldız bağlantı, 1,5dB ○ Beyaz ● Bej
12	7 674 57	
12	7 671 25	TV prizi F tipi ○ Beyaz ● Bej
12	7 674 25	
12	7 671 27	TV/SAT prizleri TV/SAT prizi, geçişli, 14 dB ○ Beyaz ● Bej
12	7 674 27	
12	7 671 28	TV/SAT prizi, sonlu, 10 dB ○ Beyaz ● Bej
12	7 674 28	
12	7 671 58	TV/SAT prizi, yıldız bağlantı ○ Beyaz ● Bej
12	7 674 58	
12	7 671 59	TV/SAT/SAT priz ○ Beyaz ● Bej
12	7 674 59	
10	7 671 60	TV/ priz kapakları TV/ priz kapağı, 2/3 delik ○ Beyaz ● Bej
10	7 674 60	



7 671 40 + 7 673 31

7 674 38 + 7 673 41

Mekanizmalar tuş kapağı ile birlikte temin edilir ve tekli ya da çoklu çerçeveler ile tamamlanır.

Sıva altı veya üstü kasalara tırnaklı veya vidalı montaj. Halojen free (Halojen içermez) mekanizma ve kaide. Ultraviyole ışınlara dayanıklı Kendiliğinden sönmeye:

- çalışan parçaları yerinde tutan yalıtkan parçalar için: + 850° C / 30 s.
- yalıtkan malzemeden yapılan diğer parçalar için: + 650° C / 30 s.

Amb.	Ref.	Telefon ve data prizleri
12	7 671 29	RJ 11, 1 çıkış
12	7 674 29	○ Beyaz ● Bej
12	7 671 30	RJ 11, 2 çıkış
12	7 674 30	○ Beyaz ● Bej
12	7 671 38	RJ 45 priz cat 5 UTP
12	7 674 38	○ Beyaz ● Bej
12	7 671 39	RJ 45 priz cat 6 UTP
12	7 674 39	○ Beyaz ● Bej
12	7 671 40	2xRJ 45 priz cat 6 UTP
12	7 674 40	○ Beyaz ● Bej
12	7 671 37	RJ 11 + RJ 45 priz cat 6 UTP
12	7 674 37	○ Beyaz ● Bej

RJ 11, 1 çıkış
○ Beyaz
● Bej



RJ 11, 2 çıkış
○ Beyaz
● Bej



RJ 45 priz cat 5 UTP
○ Beyaz
● Bej



RJ 45 priz cat 6 UTP
○ Beyaz
● Bej



2xRJ 45 priz cat 6 UTP
○ Beyaz
● Bej



RJ 11 + RJ 45 priz cat 6 UTP
○ Beyaz
● Bej



Diğer ürünler

Kablo çıkışı

Kablo çapı maks. 12 mm

10	7 671 20	○ Beyaz
10	7 674 20	● Bej



Boşluk kapağı

10	7 671 21	○ Beyaz
10	7 674 21	● Bej



Sıva üstü kasalar

Yatay veya dikey montaj
20 x 15.5 mm, 32 x 12.5 mm, 40 x 20 mm ince kanallara ve Ø 20 mm kanallara montajı yapılır. Sadece Salbei mekanizmalar ile kullanılabilir.

Tekli sıva üstü kasa

10	7 671 47	○ Beyaz
5	7 674 47	● Bej



İkili sıva üstü kasa

10	7 671 48	○ Beyaz
5	7 674 48	● Bej

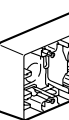

7 673 41

7 673 32

Amb.	Ref.	Çerçeveler
25	7 673 31	Beyaz çerçeveler
15	7 673 32	Tekli
10	7 673 33	İkili
1	7 673 34	Üçlü
1	7 673 35	Dörtlü
25	7 673 41	Bej çerçeveler
15	7 673 42	Tekli
10	7 673 43	İkili
1	7 673 44	Üçlü
1	7 673 45	Dörtlü
10	7 671 90	Etiket taşıyıcılı çerçeve
10	7 674 90	Beyaz
		Bej

Beyaz çerçeveler

25	7 673 31	Tekli
15	7 673 32	İkili
10	7 673 33	Üçlü
1	7 673 34	Dörtlü
1	7 673 35	Beşli

Bej çerçeveler

25	7 673 41	Tekli
15	7 673 42	İkili
10	7 673 43	Üçlü
1	7 673 44	Dörtlü
1	7 673 45	Beşli

Etiket taşıyıcılı çerçeve

10	7 671 90	Beyaz
10	7 674 90	Bej

Kumanda mekanizmaları

7 678 00 + 7 675 51



7 679 00 + 7 675 41

Mekanizmalar tuş kapağı ile birlikte temin edilir ve tekli ya da çoklu çerçeveler ile tamamlanır. Sıva altı veya üstü kasalara tırnaklı veya vidalı montaj. (Halojen içermez) mekanizma ve kaide. Ultraviyole ışınlarla dayanıklı Kendiliğinden sönmeye:

- çalışan parçaları yerinde tutan yalıtkan parçalar için: + 850° C / 30 s.
- yalıtkan malzemeden yapılan diğer parçalar için: + 650° C / 30 s.

Kumanda mekanizmaları

Amb.	Ref.	
12	7 672 00	Anahtar, 10 AX - 250 V~
12	7 673 00	● Alüminyum
12	7 675 00	● Antrasit
12	7 679 00	● Şampanya
12	7 678 00	● İnci Beyazı
12	7 676 00	● Füme
12	7 677 00	● Altın
12	7 677 00	● Roze
12	7 672 01	Vavien, 10 AX - 250 V~
12	7 673 01	● Alüminyum
12	7 675 01	● Antrasit
12	7 679 01	● Şampanya
12	7 678 01	● İnci Beyazı
12	7 676 01	● Füme
12	7 677 01	● Altın
12	7 677 01	● Roze
12	7 672 06	Komütatör, 10 AX - 250 V~
12	7 673 06	● Alüminyum
12	7 675 06	● Antrasit
12	7 679 06	● Şampanya
12	7 678 06	● İnci Beyazı
12	7 676 06	● Füme
12	7 677 06	● Altın
12	7 677 06	● Roze
12	7 672 02	Komütatör Vavien, 10 AX - 250 V~
12	7 673 02	● Alüminyum
12	7 675 02	● Antrasit
12	7 679 02	● Şampanya
12	7 678 02	● İnci Beyazı
12	7 676 02	● Füme
12	7 677 02	● Altın
12	7 677 02	● Roze
12	7 672 03	Üçlü anahtar, 10 AX - 250 V~
12	7 673 03	● Alüminyum
12	7 675 03	● Antrasit
12	7 679 03	● Şampanya
12	7 678 03	● İnci Beyazı
12	7 676 03	● Füme
12	7 677 03	● Altın
12	7 677 03	● Roze
12	7 672 04	Permütatör, 10 AX - 250 V~
12	7 673 04	Vavien kurulumuna eklenerek üçüncü bir kontrol noktasını mümkün kılar.
12	7 675 04	● Alüminyum
12	7 679 04	● Antrasit
12	7 678 04	● Şampanya
12	7 676 04	● İnci Beyazı
12	7 677 04	● Füme
12	7 677 04	● Altın
12	7 677 04	● Roze
12	7 672 05	Liht butonu, 6A - 250 V~
12	7 673 05	● Alüminyum
12	7 675 05	● Antrasit
12	7 679 05	● Şampanya
12	7 678 05	● İnci Beyazı
12	7 676 05	● Füme
12	7 677 05	● Altın
12	7 677 05	● Roze

Kumanda mekanizmaları, ışıklı kumanda mekanizmaları

7 679 06 + 7 675 51



7 673 00 + 7 673 61

Kumanda mekanizmaları (devamı)

Amb.	Ref.	
12	7 672 68	Komütatör liht butonu
12	7 673 68	● Alüminyum
12	7 675 68	● Antrasit
12	7 679 68	● Şampanya
12	7 678 68	● İnci Beyazı
12	7 676 68	● Füme
12	7 677 68	● Altın
12	7 677 68	● Roze
12	7 672 09	Panjur-Stor anahtarı, 6 AX - 250 V~
12	7 673 09	Motorun direkt kontrolü için 3 seviye: yukarı-dur-aşağı
12	7 675 09	● Alüminyum
12	7 679 09	● Antrasit
12	7 678 09	● Şampanya
12	7 676 09	● İnci Beyazı
12	7 677 09	● Füme
12	7 677 09	● Altın
12	7 677 09	● Roze
12	7 672 69	Panjur-Stortor liht
12	7 673 69	● Alüminyum
12	7 675 69	● Antrasit
12	7 679 69	● Şampanya
12	7 678 69	● İnci Beyazı
12	7 676 69	● Füme
12	7 677 69	● Altın
12	7 677 69	● Roze
12	7 672 66	İşıklı kumanda mekanizmaları
12	7 673 66	İşıklı Anahtar
12	7 675 66	● Alüminyum
12	7 679 66	● Antrasit
12	7 678 66	● Şampanya
12	7 676 66	● İnci Beyazı
12	7 677 66	● Füme
12	7 677 66	● Altın
12	7 677 66	● Roze
12	7 672 08	İşıklı Vavien
12	7 673 08	● Alüminyum
12	7 675 08	● Antrasit
12	7 679 08	● Şampanya
12	7 678 08	● İnci Beyazı
12	7 676 08	● Füme
12	7 677 08	● Altın
12	7 677 08	● Roze
12	7 672 67	İşıklı liht butonu
12	7 673 67	● Alüminyum
12	7 675 67	● Antrasit
12	7 679 67	● Şampanya
12	7 678 67	● İnci Beyazı
12	7 676 67	● Füme
12	7 677 67	● Altın
12	7 677 67	● Roze

Dimmer, energy saver, prizler



7 672 10 + 7 673 51



7 677 14 + 7 675 71

Mekanizmalar tuş kapağı ile birlikte temin edilir ve tekli ya da çoklu çerçeveler ile tamamlanır. Sıva altı veya üstü kasalara tırnaklı veya vidalı montaj. Halojen free (Halojen içermez) mekanizma ve kaide. Ultraviyole ışınlarla dayanıklı. Kendiliğinden sönmeye: • çalışan parçaları yerinde tutan yalıtkan parçalar için: + 850° C / 30 s. • yalıtkan malzemeden yapılan diğer parçalar için: + 650° C / 30 s.

Amb.	Ref.	Çevirmeli dimmer
		Standart anahtar mekanizmasının yerine monte edilebilir. Sınırsız dönebilen düğme. Çevrilebilir düğme ortasından ON/OFF
		Çevirmeli dimmer 400 W
1	7 672 10	● Alüminyum
1	7 673 10	● Antrasit
1	7 675 10	● Şampanya
1	7 679 10	● İnci Beyazı
1	7 678 10	● Füme
1	7 676 10	● Altın
1	7 677 10	● Roze
		LED çevirmeli dimmer 300 W RLC
1	7 672 12	● Alüminyum
1	7 673 12	● Antrasit
1	7 675 12	● Şampanya
1	7 679 12	● İnci Beyazı
1	7 678 12	● Füme
1	7 676 12	● Altın
1	7 677 12	● Roze

Amb.	Ref.	Energy saver
		30 sn. gecikmeli
1	7 672 11	● Alüminyum
1	7 673 11	● Antrasit
1	7 675 11	● Şampanya
1	7 679 11	● İnci Beyazı
1	7 678 11	● Füme
1	7 676 11	● Altın
1	7 677 11	● Roze

Amb.	Ref.	Prizler
		Topraklı priz
12	7 672 14	● Alüminyum
12	7 673 14	● Antrasit
12	7 675 14	● Şampanya
12	7 679 14	● İnci Beyazı
12	7 678 14	● Füme
12	7 676 14	● Altın
12	7 677 14	● Roze

Amb.	Ref.	Çocuk korumalı topraklı priz
12	7 672 15	● Alüminyum
12	7 673 15	● Antrasit
12	7 675 15	● Şampanya
12	7 679 15	● İnci Beyazı
12	7 678 15	● Füme
12	7 676 15	● Altın
12	7 677 15	● Roze

Amb.	Ref.	İkili topraklı priz
		2 modül buata montaj yapılır. Komple temin edilir.
10	7 672 16	● Alüminyum
10	7 673 16	● Antrasit
10	7 675 16	● Şampanya
10	7 679 16	● İnci Beyazı
10	7 678 16	● Füme
10	7 676 16	● Altın
10	7 677 16	● Roze
10	7 675 18	● Şampanya

Amb.	Ref.	Fransız standardı çocuk korumalı topraklı priz, UPS
12	7 672 17	● Alüminyum
12	7 673 17	● Antrasit
12	7 675 17	● Şampanya
12	7 679 17	● İnci Beyazı
12	7 678 17	● Füme
12	7 676 17	● Altın
12	7 677 17	● Roze

Prizler, TV prizleri



7 675 18 + 7 673 71



7 678 27 + 7 675 51

Amb.	Ref.	Prizler (devamı)
		Kapaklı çocuk korumalı topraklı priz
10	7 672 18	● Alüminyum
10	7 673 18	● Antrasit
10	7 675 18	● Şampanya
10	7 679 18	● İnci Beyazı
10	7 678 18	● Füme
10	7 676 18	● Altın
10	7 677 18	● Roze

Amb.	Ref.	TV prizleri
		TV prizi geçişli 14dB
12	7 672 23	● Alüminyum
12	7 673 23	● Antrasit
12	7 675 23	● Şampanya
12	7 679 23	● İnci Beyazı
12	7 678 23	● Füme
12	7 676 23	● Altın
12	7 677 23	● Roze
		TV prizi geçişli sonlu 5dB
12	7 672 26	● Alüminyum
12	7 673 26	● Antrasit
12	7 675 26	● Şampanya
12	7 679 26	● İnci Beyazı
12	7 678 26	● Füme
12	7 676 26	● Altın
12	7 677 26	● Roze
		TV prizi yıldız bağlantılı 1,5dB
12	7 672 57	● Alüminyum
12	7 673 57	● Antrasit
12	7 675 57	● Şampanya
12	7 679 57	● İnci Beyazı
12	7 678 57	● Füme
12	7 676 57	● Altın
12	7 677 57	● Roze
		TV prizi F tipi
12	7 672 25	● Alüminyum
12	7 673 25	● Antrasit
12	7 675 25	● Şampanya
12	7 679 25	● İnci Beyazı
12	7 678 25	● Füme
12	7 676 25	● Altın
12	7 677 25	● Roze

Amb.	Ref.	TV/SAT prizleri
		TV/SAT prizi, geçişli, 14 dB
12	7 672 27	● Alüminyum
12	7 673 27	● Antrasit
12	7 675 27	● Şampanya
12	7 679 27	● İnci Beyazı
12	7 678 27	● Füme
12	7 676 27	● Altın
12	7 677 27	● Roze
		TV/SAT prizi, sonlu, 12 dB
12	7 672 28	● Alüminyum
12	7 673 28	● Antrasit
12	7 675 28	● Şampanya
12	7 679 28	● İnci Beyazı
12	7 678 28	● Füme
12	7 676 28	● Altın
12	7 677 28	● Roze

TV prizleri, TV priz kapakları, telefon ve data prizleri

7 675 58 + 7 673 71



7 678 38 + 7 675 61

Mekanizmalar tuş kapağı ile birlikte temin edilir ve tekli ya da çoklu çerçeveler ile tamamlanır.

Sıva altı veya üstü kasalara tırnaklı veya vidalı montaj.

Halojen free (Halojen içermez) mekanizma ve kaide

Ultraviyole ışınlara dayanıklı

Kendiliğinden sönmeye:

• çalışan parçaları yerinde tutan yalıtkan parçalar için: + 850° C / 30 s.

• yalıtkan malzemeden yapılan diğer parçalar için: + 650° C / 30 s.

Amb. Ref. TV/SAT prizleri (devamı)

Amb.	Ref.	TV/SAT prizleri (devamı)
12	7 672 58	<ul style="list-style-type: none"> Alüminyum Antrasit Şampanya İnci Beyazı Füme Altın Roze
12	7 673 58	
12	7 675 58	
12	7 679 58	
12	7 678 58	
12	7 676 58	
12	7 677 58	
12	7 672 59	<ul style="list-style-type: none"> Alüminyum Antrasit Şampanya İnci Beyazı Füme Altın Roze
12	7 673 59	
12	7 675 59	
12	7 679 59	
12	7 678 59	
12	7 676 59	
12	7 677 59	

Amb. Ref. TV priz kapakları TV priz kapağı, 2/3 delik

Amb.	Ref.	TV priz kapakları
10	7 672 60	<ul style="list-style-type: none"> Alüminyum Antrasit Şampanya İnci Beyazı Füme Altın Roze
10	7 673 60	
10	7 675 60	
10	7 679 60	
10	7 678 60	
10	7 676 60	
10	7 677 60	

Amb. Ref. Telefon ve data prizleri

Amb.	Ref.	Telefon ve data prizleri
12	7 672 29	<ul style="list-style-type: none"> Alüminyum Antrasit Şampanya İnci Beyazı Füme Altın Roze
12	7 673 29	
12	7 675 29	
12	7 679 29	
12	7 678 29	
12	7 676 29	
12	7 677 29	
12	7 672 30	<ul style="list-style-type: none"> Alüminyum Antrasit Şampanya İnci Beyazı Füme Altın Roze
12	7 673 30	
12	7 675 30	
12	7 679 30	
12	7 678 30	
12	7 676 30	
12	7 677 30	
12	7 672 38	<ul style="list-style-type: none"> Alüminyum Antrasit Şampanya İnci Beyazı Füme Altın Roze
12	7 673 38	
12	7 675 38	
12	7 679 38	
12	7 678 38	
12	7 676 38	
12	7 677 38	
12	7 672 39	<ul style="list-style-type: none"> Alüminyum Antrasit Şampanya İnci Beyazı Füme Altın Roze
12	7 673 39	
12	7 675 39	
12	7 679 39	
12	7 678 39	
12	7 676 39	
12	7 677 39	

Telefon ve data prizleri, diğer ürünler

7 672 21 + 7 673 51

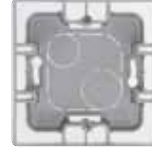

7 673 47

Amb. Ref. Telefon ve data prizleri (devamı)

Amb.	Ref.	Telefon ve data prizleri (devamı)
12	7 672 40	<ul style="list-style-type: none"> Alüminyum Antrasit Şampanya İnci Beyazı Füme Altın Roze
12	7 673 40	
12	7 675 40	
12	7 679 40	
12	7 678 40	
12	7 676 40	
12	7 677 40	
12	7 672 37	<ul style="list-style-type: none"> Alüminyum Antrasit Şampanya İnci Beyazı Füme Altın Roze
12	7 673 37	
12	7 675 37	
12	7 679 37	
12	7 678 37	
12	7 676 37	
12	7 677 37	

Amb. Ref. Diğer ürünler

Amb.	Ref.	Diğer ürünler
10	7 672 20	<ul style="list-style-type: none"> Alüminyum Antrasit Şampanya İnci Beyazı Füme Altın Roze
10	7 673 20	
10	7 675 20	
10	7 679 20	
10	7 678 20	
10	7 676 20	
10	7 677 20	
10	7 672 21	<ul style="list-style-type: none"> Alüminyum Antrasit Şampanya İnci Beyazı Füme Altın Roze
10	7 673 21	
10	7 675 21	
10	7 679 21	
10	7 678 21	
10	7 676 21	
10	7 677 21	

Amb. Ref. Sıva üstü kasalar

Yatay veya dikey montaj
20 x 15,5 mm, 32 x 12,5 mm, 40 x 20 mm ince kanallara ve Ø 20 mm kanallara montajı yapılır.
Sadece Salbei mekanizmalar ile kullanılabilir.

Amb.	Ref.	Tekli sıva üstü kasa
10	7 672 47	<ul style="list-style-type: none"> Alüminyum Antrasit Şampanya İnci Beyazı Füme Altın Roze
10	7 673 47	
10	7 675 47	
10	7 679 47	
10	7 678 47	
10	7 676 47	
10	7 677 47	
5	7 672 48	<ul style="list-style-type: none"> Alüminyum Antrasit Şampanya İnci Beyazı Füme Altın Roze
5	7 673 48	
5	7 675 48	
5	7 679 48	
5	7 678 48	
5	7 676 48	
5	7 677 48	

Çerçeveser



7 675 41

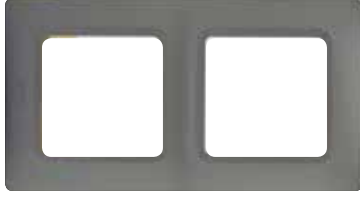

7 675 52



7 675 71



7 675 62

Amb.	Ref.	Çerçeveser
		Alüminyum çerçeveser
25	7 673 51	Tekli
15	7 673 52	İkili
10	7 673 53	Üçlü
1	7 673 54	Dörtlü
1	7 673 55	Beşli
		Antrasit çerçeveser
25	7 673 61	Tekli
15	7 673 62	İkili
10	7 673 63	Üçlü
1	7 673 64	Dörtlü
1	7 673 65	Beşli
		Şampanya çerçeveser
25	7 673 71	Tekli
15	7 673 72	İkili
10	7 673 73	Üçlü
1	7 673 74	Dörtlü
1	7 673 75	Beşli
		İnci Beyazı çerçeveser
25	7 675 41	Tekli
15	7 675 42	İkili
10	7 675 43	Üçlü
1	7 675 44	Dörtlü
1	7 675 45	Beşli
		Füme çerçeveser
25	7 675 51	Tekli
15	7 675 52	İkili
10	7 675 53	Üçlü
1	7 675 54	Dörtlü
1	7 675 55	Beşli

Amb.	Ref.	Çerçeveser (devamı)
		Altın çerçeveser
25	7 675 61	Tekli
15	7 675 62	İkili
10	7 675 63	Üçlü
1	7 675 64	Dörtlü
1	7 675 65	Beşli
		Roze çerçeveser
25	7 675 71	Tekli
15	7 675 72	İkili
10	7 675 73	Üçlü
1	7 675 74	Dörtlü
1	7 675 75	Beşli
		Ahşap çerçeveser
25	7 673 81	Tekli
15	7 673 82	İkili
10	7 673 83	Üçlü
1	7 673 84	Dörtlü
1	7 673 85	Beşli
		Koyu Ahşap çerçeveser
25	7 675 31	Tekli
15	7 675 32	İkili
10	7 675 33	Üçlü
1	7 675 34	Dörtlü
1	7 675 35	Beşli
		Etiket taşıyıcı çerçeve
10	7 672 90	Alüminyum
10	7 673 90	Antrasit
10	7 675 90	Şampanya
10	7 679 90	İnci Beyazı
10	7 678 90	Füme
10	7 676 90	Altın
10	7 677 90	Roze

Salbei™ mekanizma teknik özellikler

Kumanda mekanizmaları

Anahtar
7 67X 00

10 AX - 250 V~

13 mm

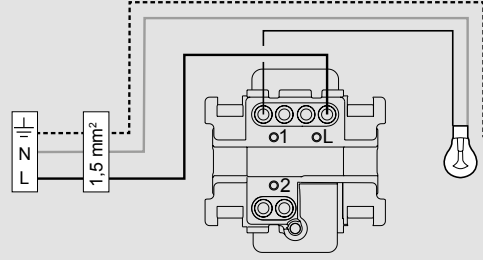
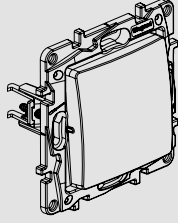

Işıklı anahtar
7 67X 66*

10 AX - 250 V~

13 mm

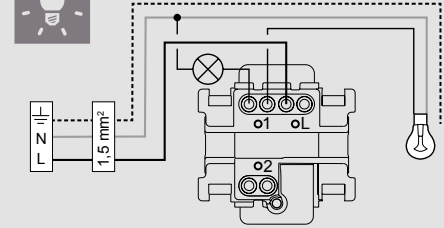
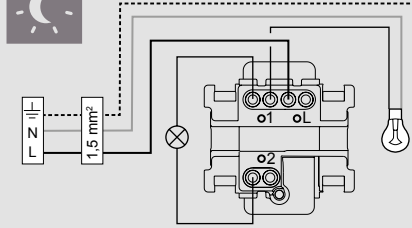
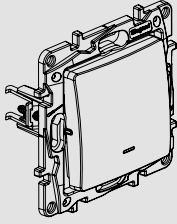

*Sadece renkli mekanizmalar

Vavien
7 67X 01

10 AX - 250 V~

13 mm

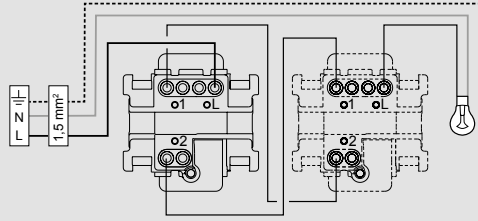
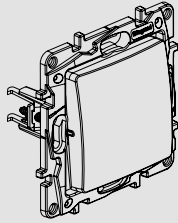

Işıklı vavien
7 67X 08*

10 AX - 250 V~

13 mm

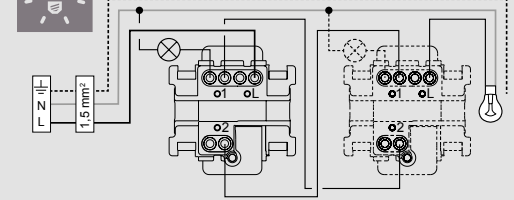
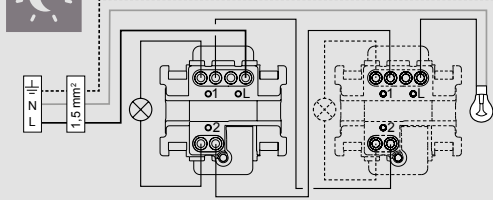
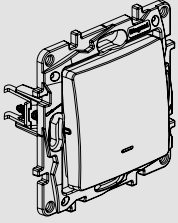

*Sadece renkli mekanizmalar

Liht butonu
7 67X 05

6 A - 250 V~

13 mm

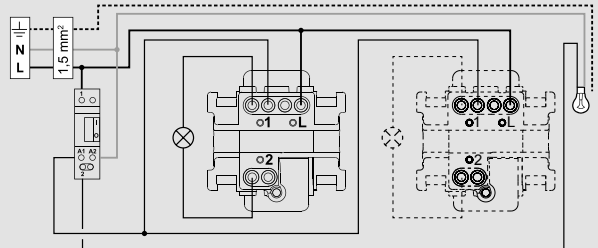
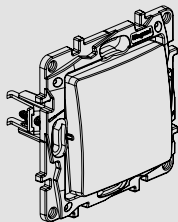

Komütatör
7 67X 06

10 AX - 250 V~

13 mm

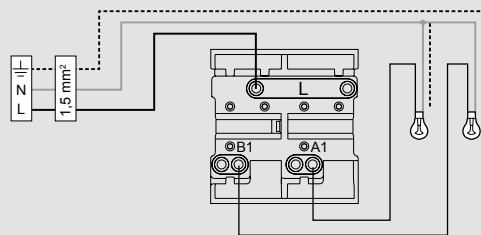
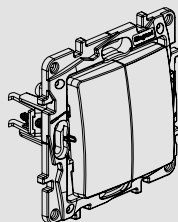

Salbei™ mekanizma teknik özellikler

Kumanda mekanizmaları

Komütatör vavien
7 67X 02

10 AX - 250 V~

13 mm

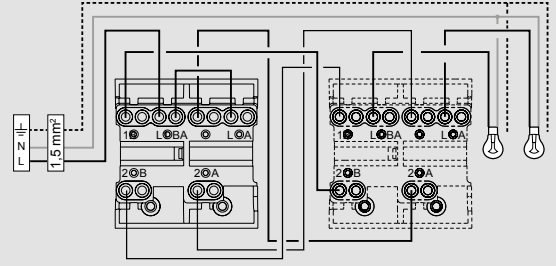
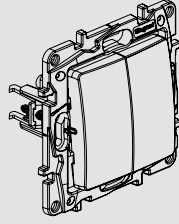

Üçlü anahtar
7 67X 03

10 AX - 250 V~

10 mm

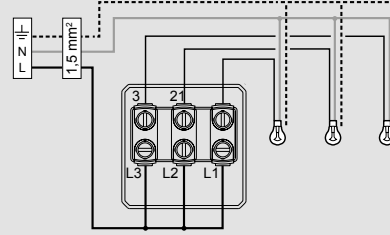
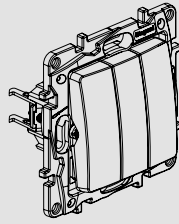

Permütatör
7 67X 04

10 AX - 250 V~

10 mm

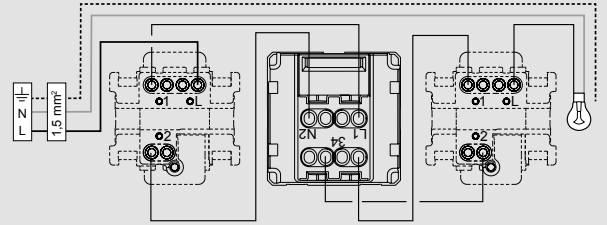
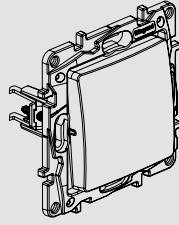

Işıklı liht butonu
7 67X 67*

6 A - 250 V~

13 mm

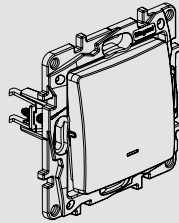

Işıklı

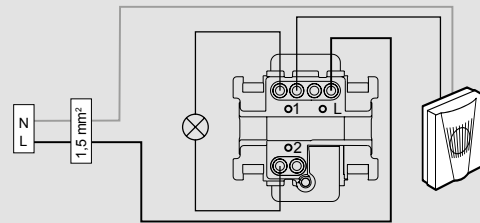

*Sadece renkli mekanizmalar

Permütatör anahtar
7 67X 09

10 AX - 250 V~

8 mm

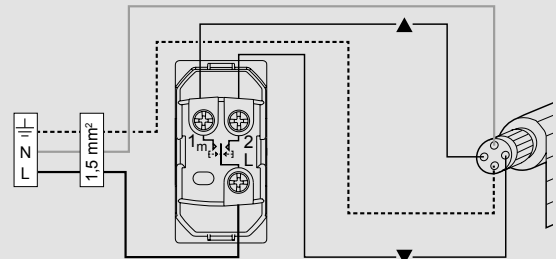
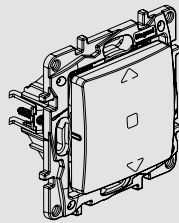

Panjur/stor liht butonu
7 67X 69

6 A - 250 V~

8 mm

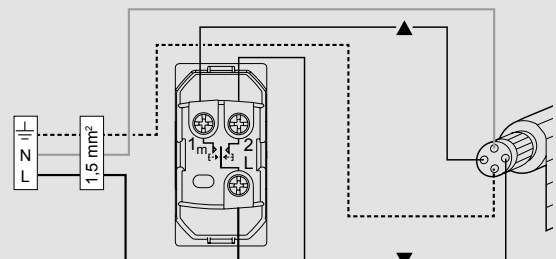
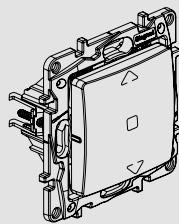

Salbei™ mekanizma teknik özellikler

LED lamba

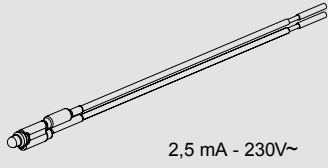

2,5 mA - 230V~

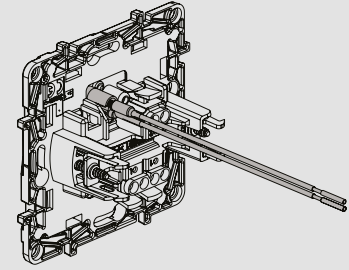
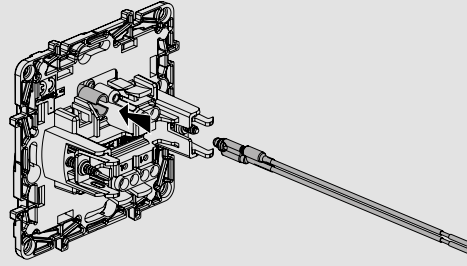

Işıklı anahtar 7 67X 66*

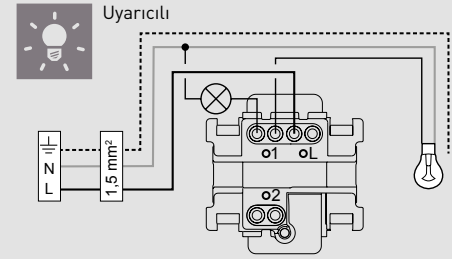
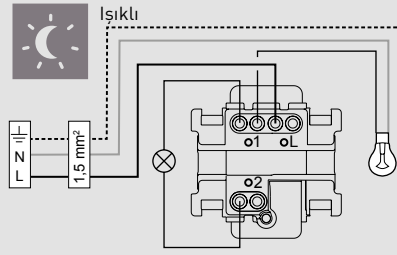
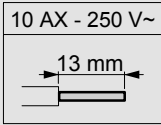
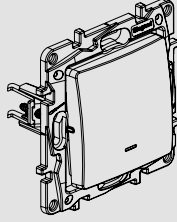

*Sadece renkli mekanizmalar

Işıklı anahtar 7 67X 08*

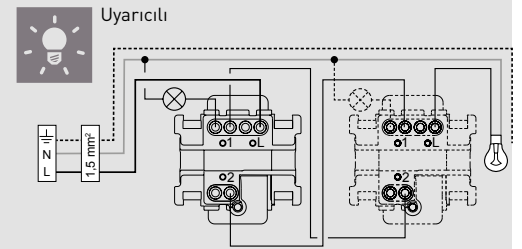
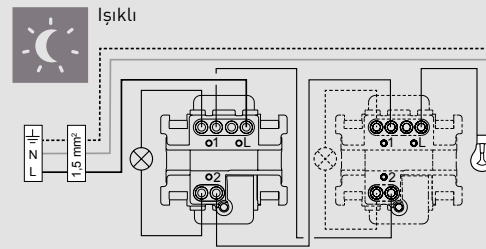
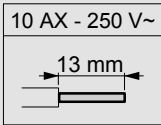
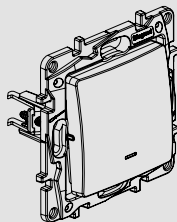

*Sadece renkli mekanizmalar

liht butonu 7 67X 05

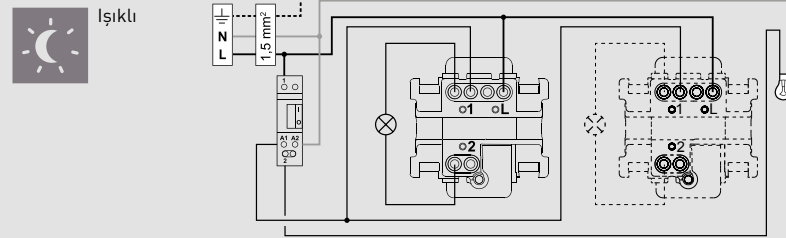
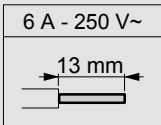
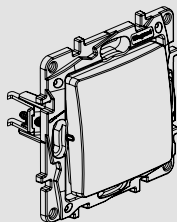

Komütatör 7 67X 06

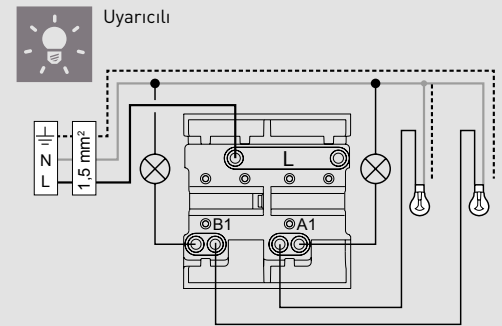
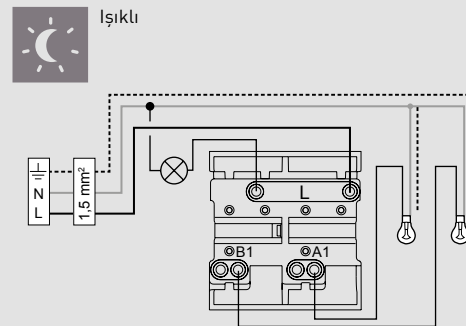
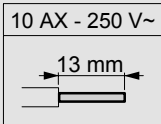
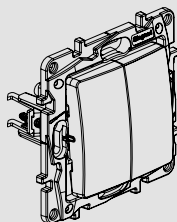

Salbei™ mekanizma teknik özellikler

LED lamba

Komütatör liht 7 67X 68

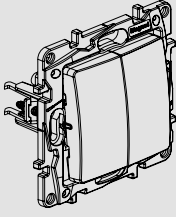

6 A - 250 V~

13 mm



Işıklı

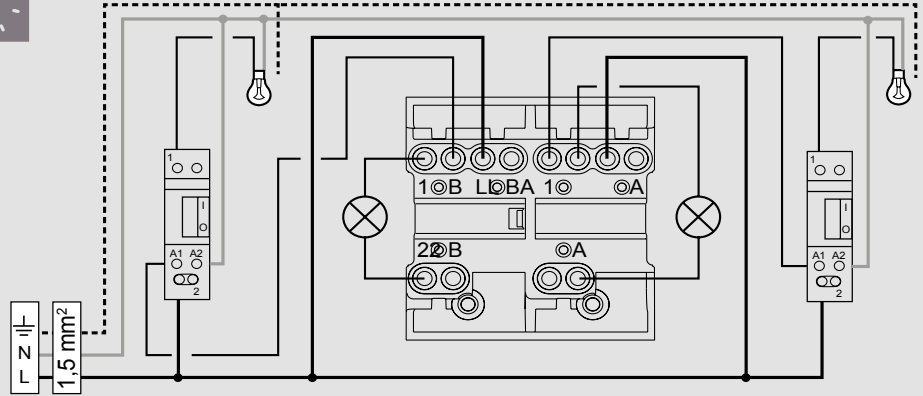

Komütatör vavien 7 67X 02

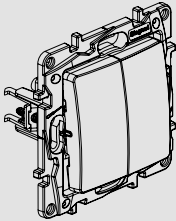

10 AX - 250 V~

10 mm



Işıklı

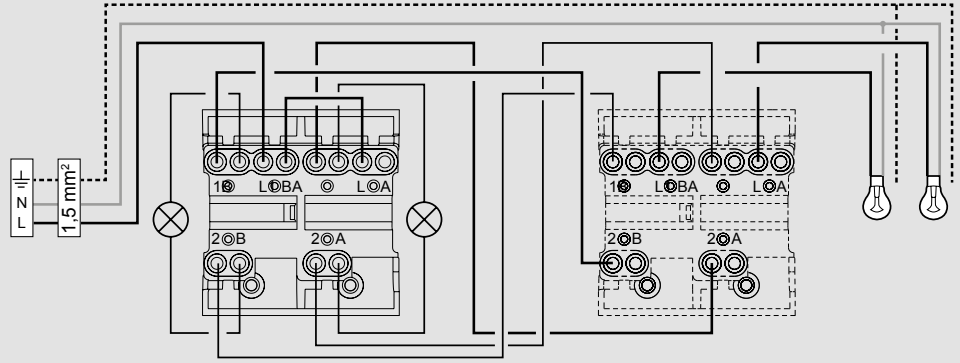

Permütatör 7 67X 04

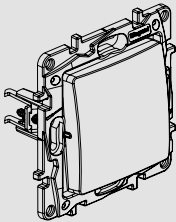

10 AX - 250 V~

10 mm



Işıklı

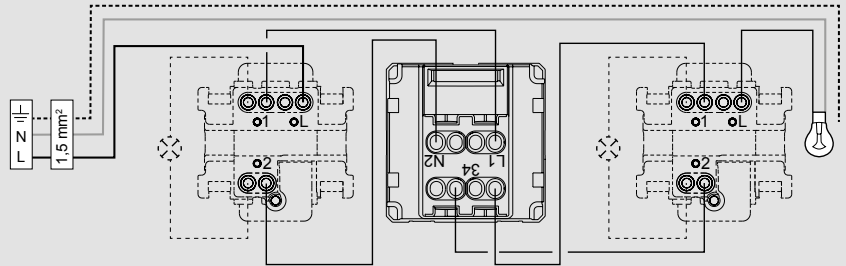

*Sadece renkli mekanizmalar

Işıklı liht butonu 7 67X 67*

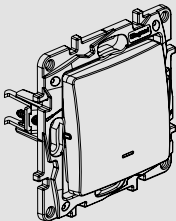

6 A - 250 V~

13 mm



Işıklı

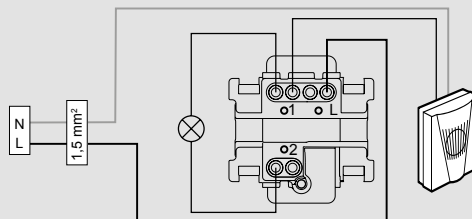

*Sadece renkli mekanizmalar

Salbei™ mekanizma teknik özellikler

Prizler

Topraklı priz
7 67X 14

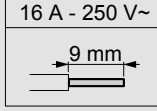
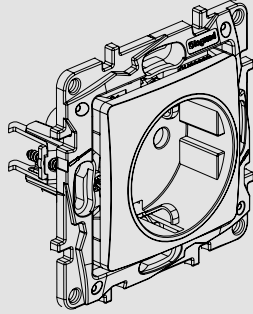

Çocuk korumalı topraklı priz
7 67X 15

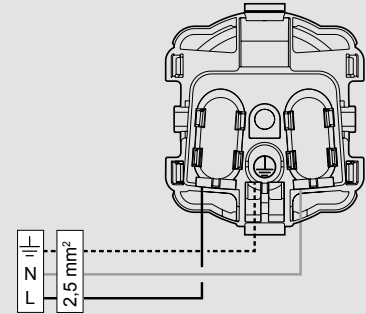
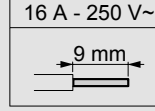
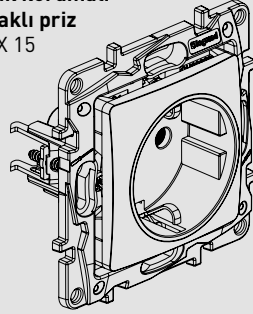

İkili topraklı priz
7 67X 16

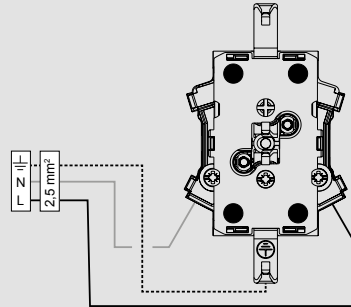
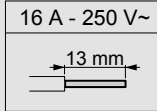
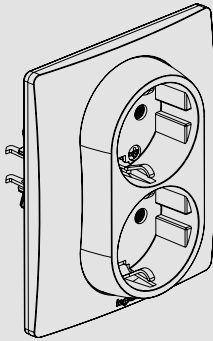

Fransız standardı topraklı priz
7 67X 17

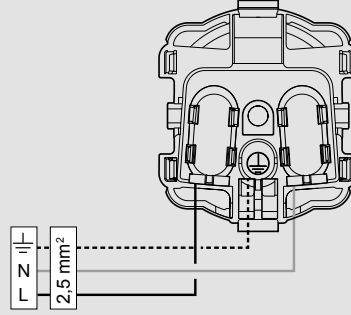
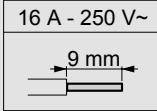
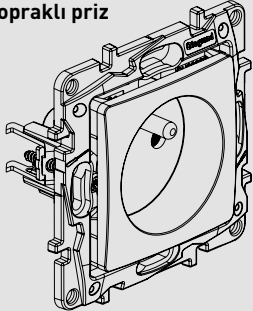

Kapaklı topraklı priz
7 67X 18

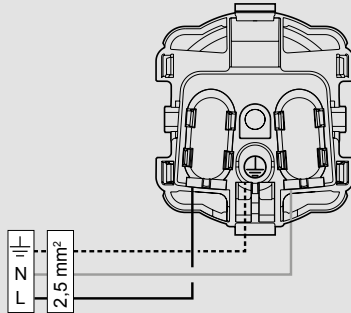
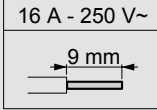
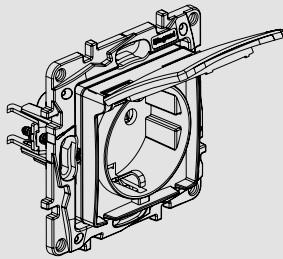

Fransız standardı çocuk topraklı priz
7 67X 19

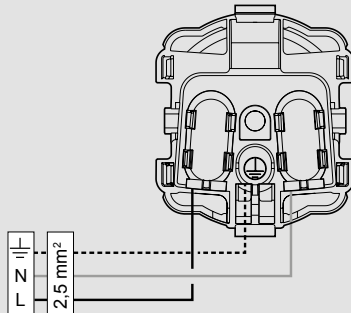
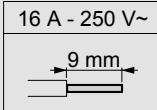
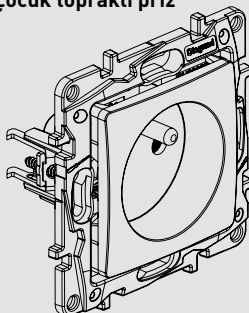

Salbei™ mekanizma teknik özellikler

Dimmerler

LED dimmer çevirmeli 7 67X 12

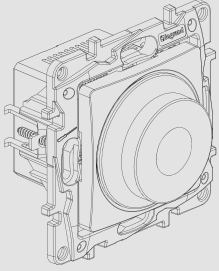

			U	
-10°C ... +70°C0	°C ... +35°C	40 mm	100 .. 240 V~ 50 / 60 Hz	8 mm 1... 2,5 mm ²

	RL		C/L		DimmableD	immable LED
200-240V~ 50 / 60 Hz	5.. 300 W5	.. 300 VA	5.. 300 VA	5.. 75 W ≤= 10 x		
100-200V~ 50 / 60 Hz	5.. 150 W5	.. 150 VA	5.. 150 VA	5.. 37 W ≤= 10 x		

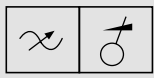

Bağlantı şeması

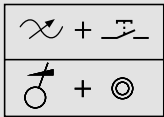
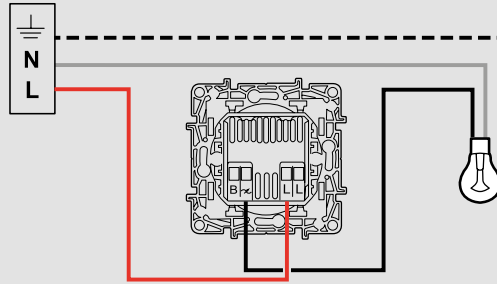
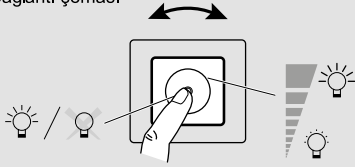

Vavien anahtar
ile kullanımı

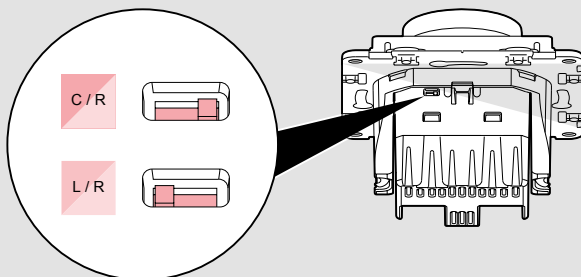
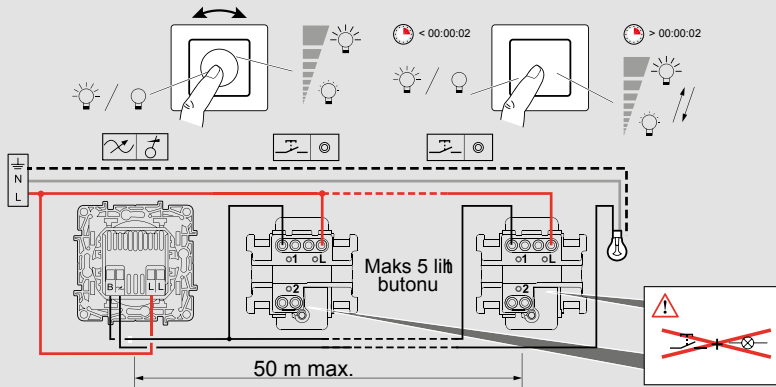

Salbei™ mekanizma teknik özellikler

Dimmerler (devamı)

LED dimmer çevirmeli 7 67X 12

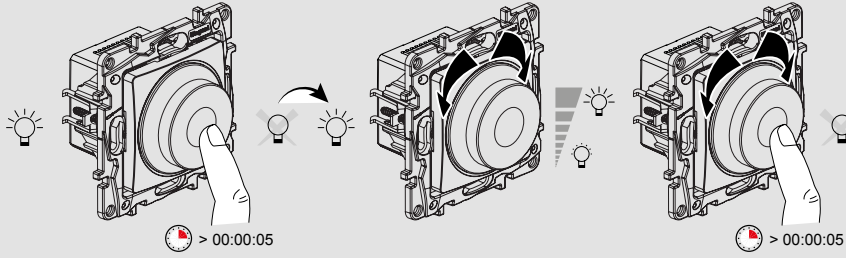

min.

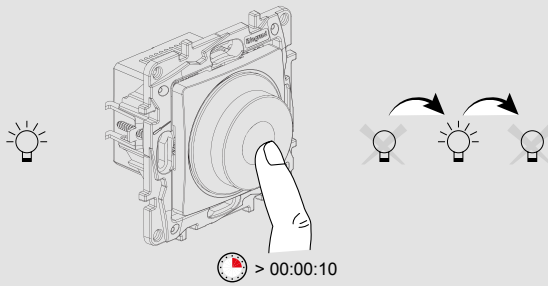

Dimmer 400 W 7 67X 17

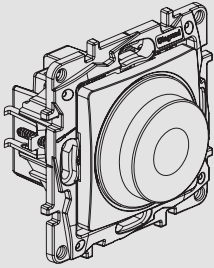

 35° 0° 100-240 V 50/60 Hz	 2 x 2,5 mm ²	 	 	 +
240 V	Max.	400 W	400 W	400 VA
	Min.	20 W	20 W	20 VA
100 V	Max.	200 W	200 W	200 VA
	Min.	20 W	20 W	20 VA

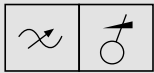
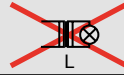

Bağlantı şeması

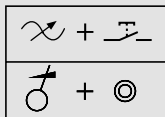
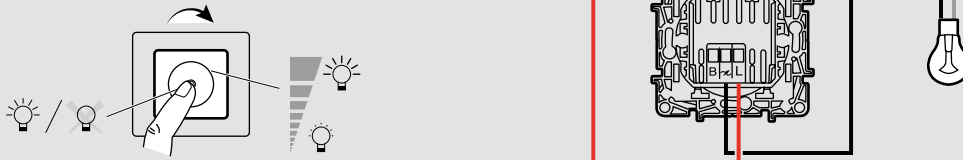

Vavien anahtar
ile kullanımı

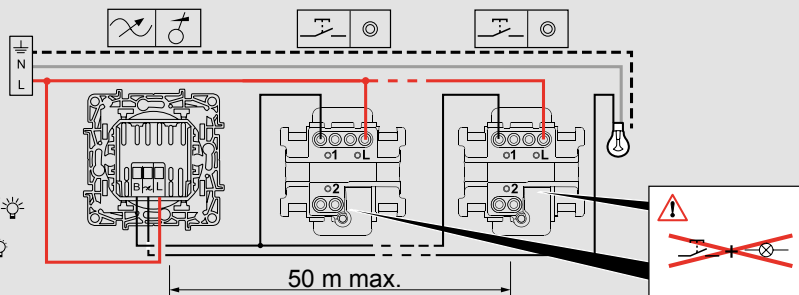
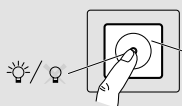

Energy saver (devamı)
7 67X 11

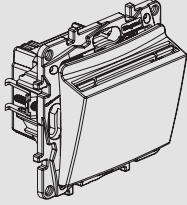

UP				
110 / 230 V~ 50/60 HZ	< 12 W / 230 V~ < 3 W / 110 V~	230 V~ 2 A 60 VA	2 X 2,5 MM ²	- 10° C + 55° C

Montaj şekilleri

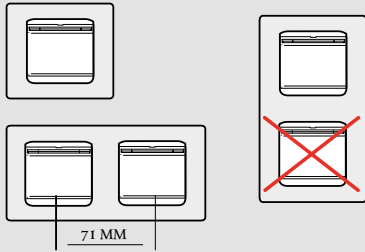

Bağlantı şeması

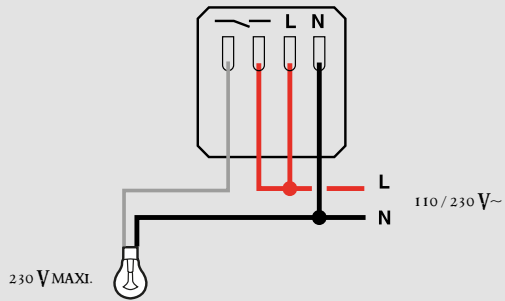

Montaj

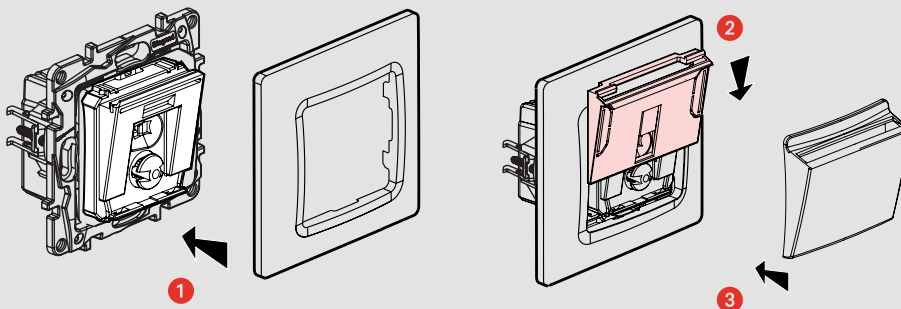

Energy saver (devamı)
7 67X 11

Çalışma

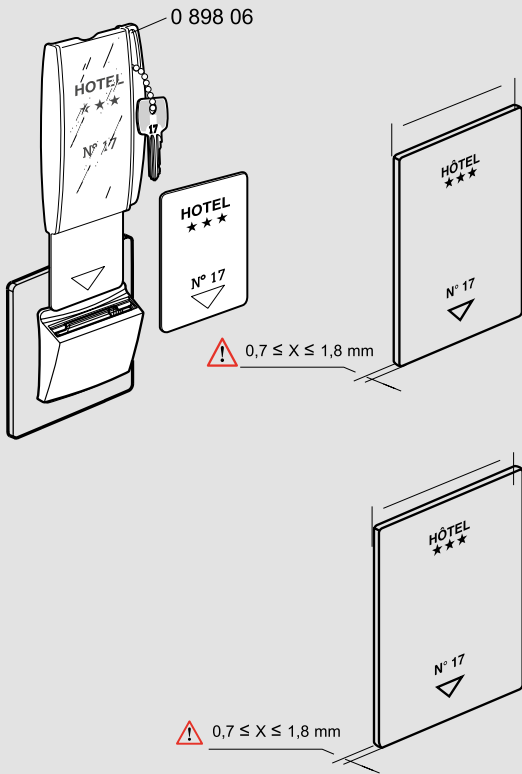
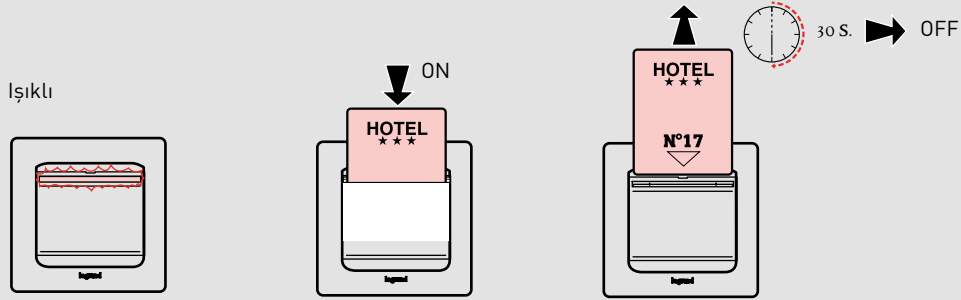

Standart kredi kartı genişliğindeki kartlar için tırnakları kırın

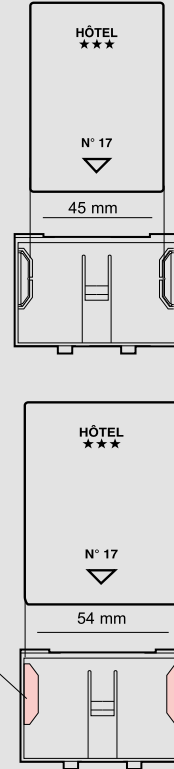

Bakım

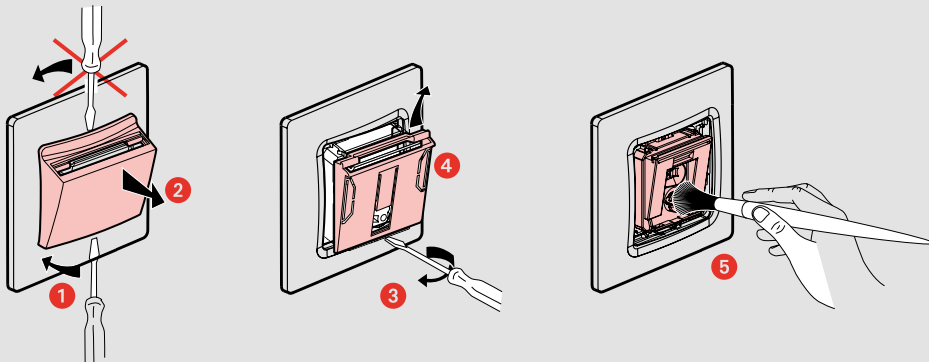

Geçiş sonlu TV prizleri
7 67X 23/26

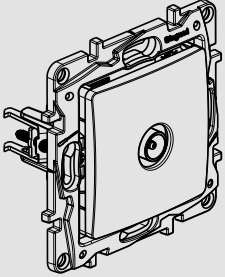
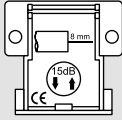
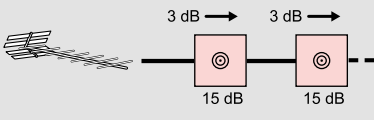
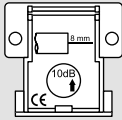
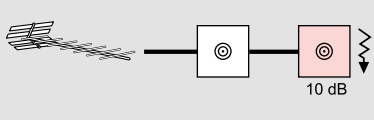
TV (5 - 862 MHz)	7 67X 23			
	7 67X 26			

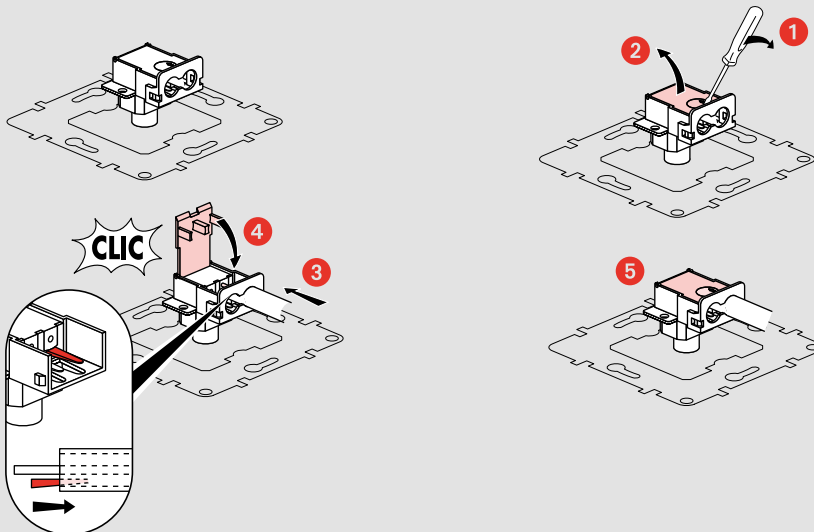
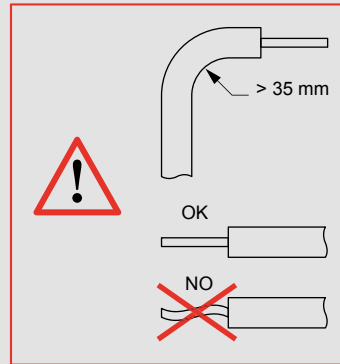
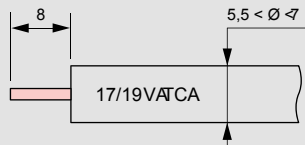

TV-SAT
7 67X 27/28/58

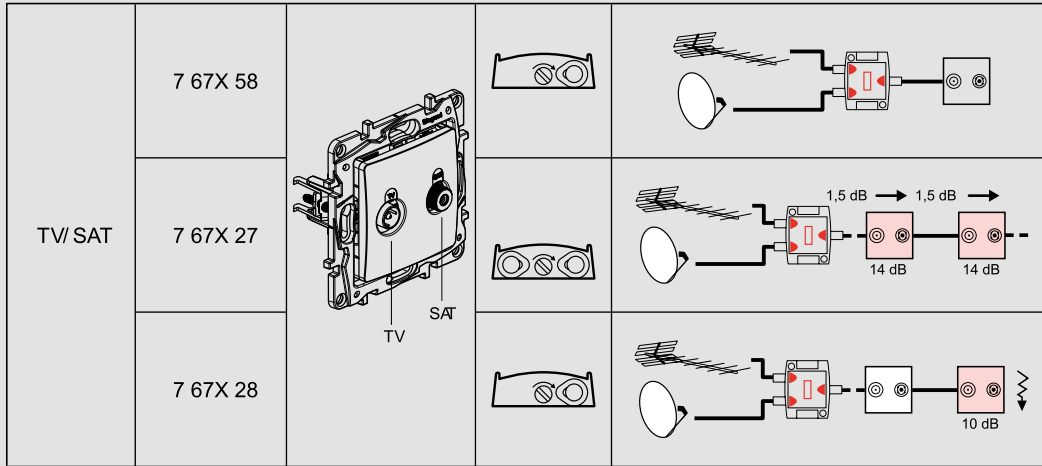

		-mA DC	22 KHz 0,6 V	Return channel 4-30 MHz	VHF1 47-68 MHz	R 87,5-108 MHz	VHF3 120-470 MHz	UHF 470-862 MHz	IF1 950-2150 MHz	IF2 2150-2400 MHz	
7 67X 58	TV			1,5 dB							
	SAT	500 mA	1,5 dB							2 dB	
7 67X 27	TV			14 dB							
	SAT	500 mA	1,5 dB							14 dB	
7 67X 28	TV			10 dB							
	SAT	500 mA	1,5 dB							10 dB	

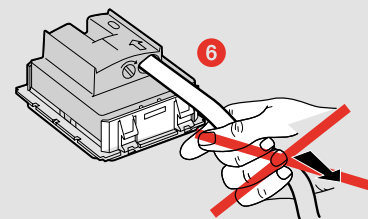
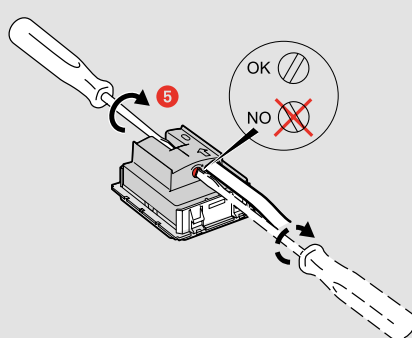
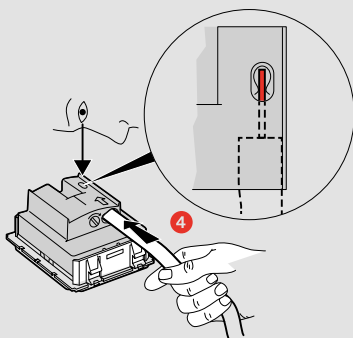
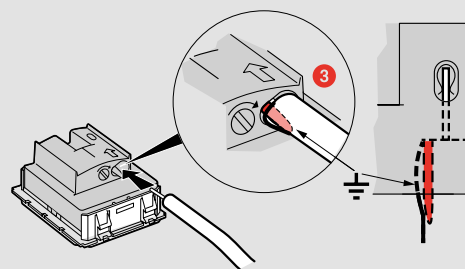
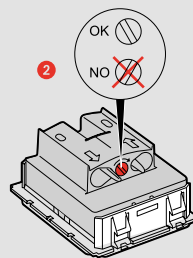
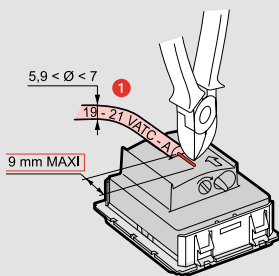
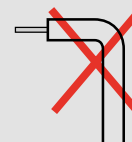
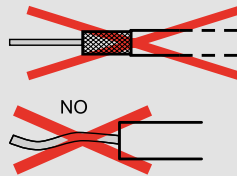
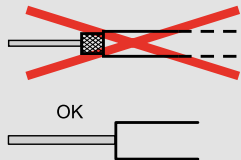

Telefon / data prizleri
7 67X 29/30/37/38/39/40

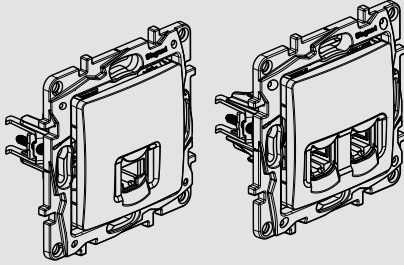

RJ 11	7 67X 29
2 RJ11	7 67X 30
RJ 11 + RJ 45 Cat 5e UTP	7 67X 37
RJ45 Cat 5e UTP	7 67 X 38
RJ 45 Cat 6 UTP	7 67X 39
2 RJ 45 Cat 6 UTP	7 67X 40

■ RJ11

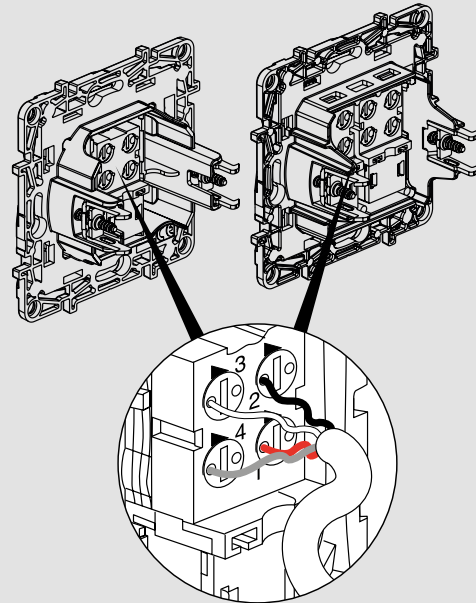
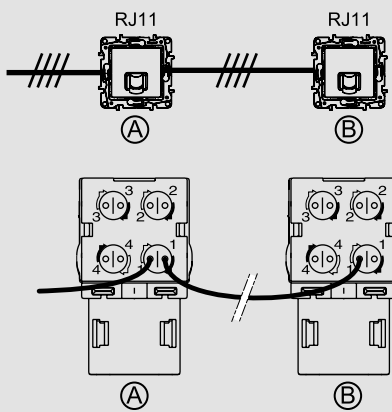
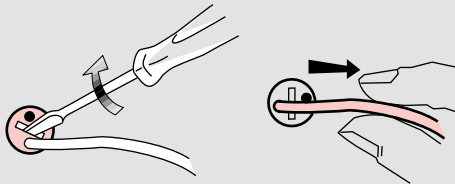
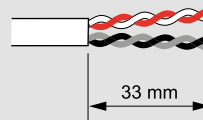
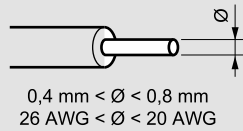
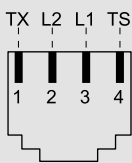

■ RJ45

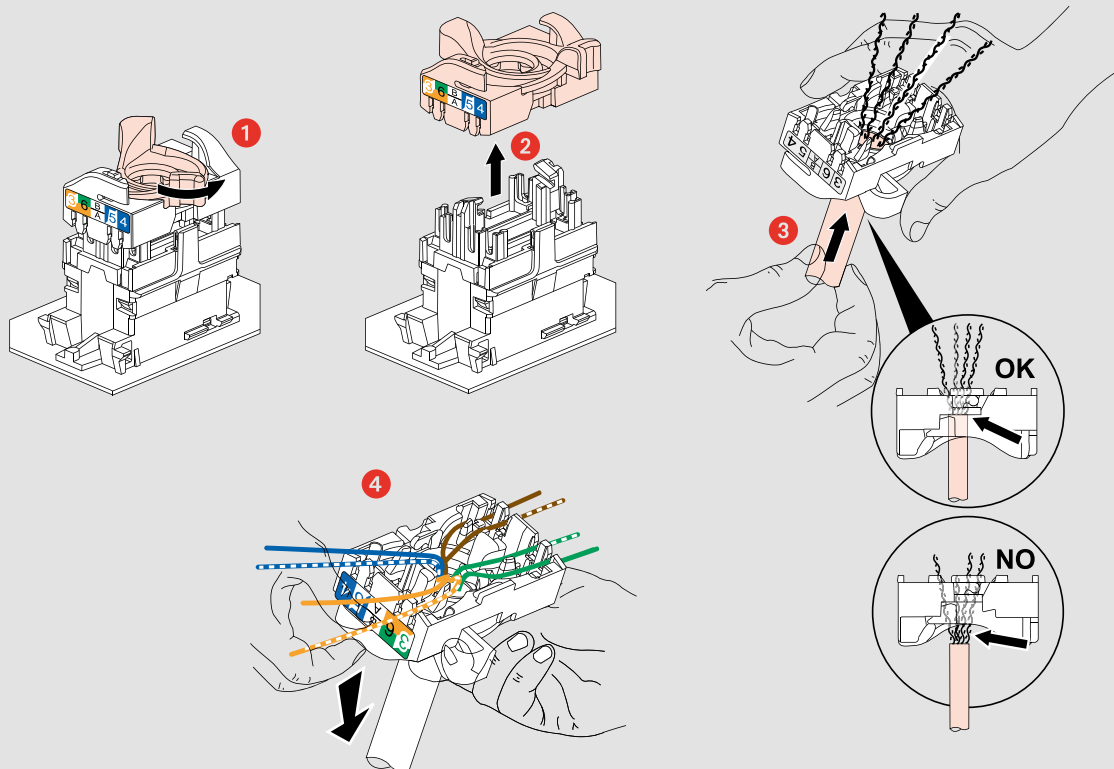
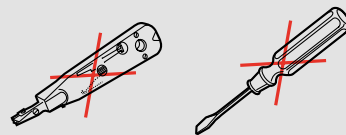
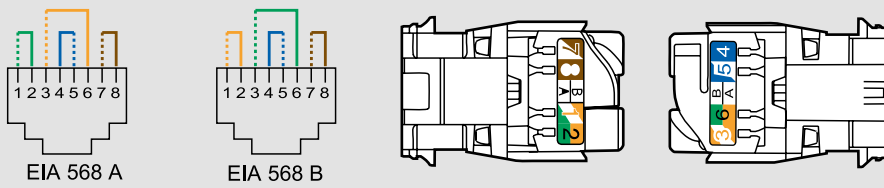
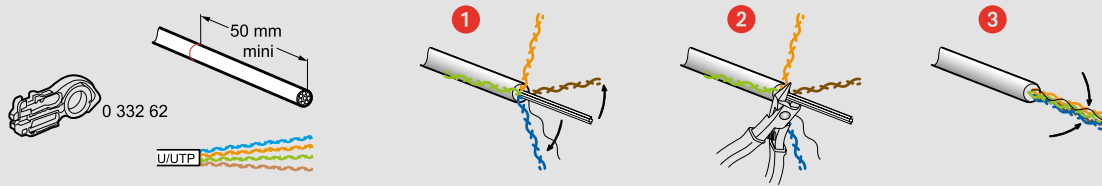

■ RJ45

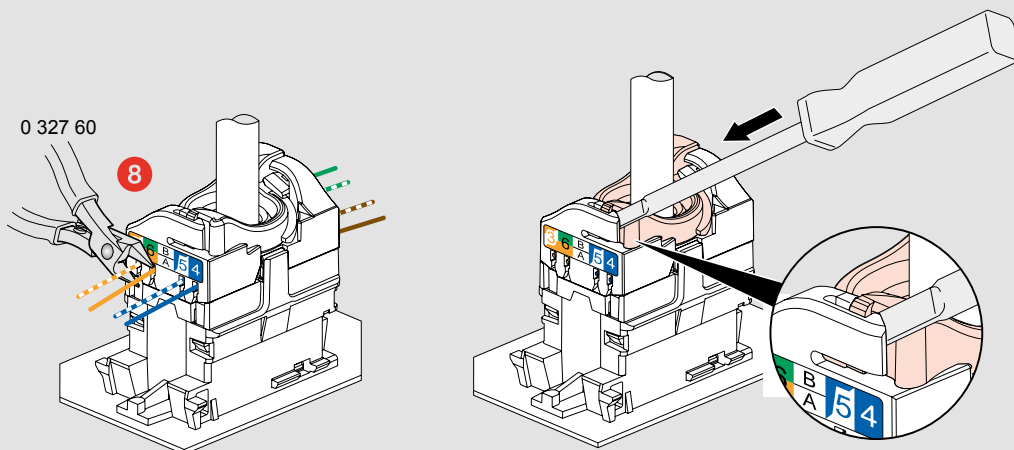
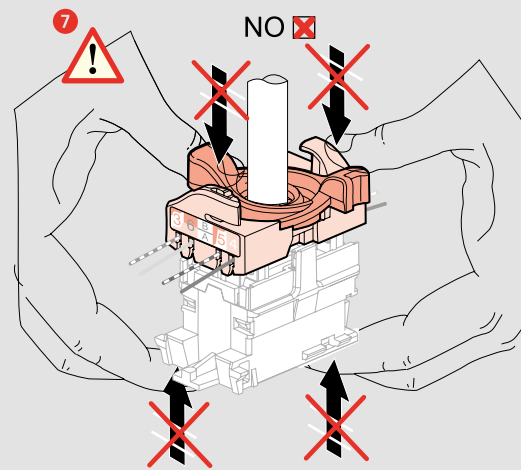
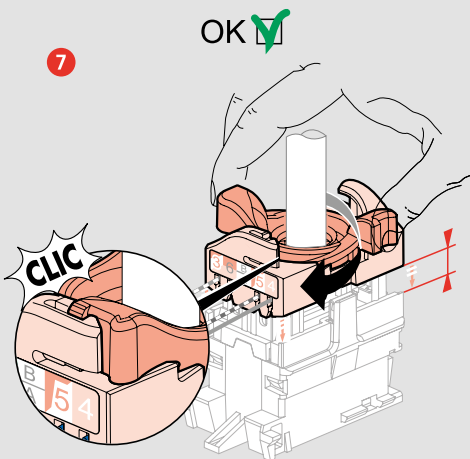
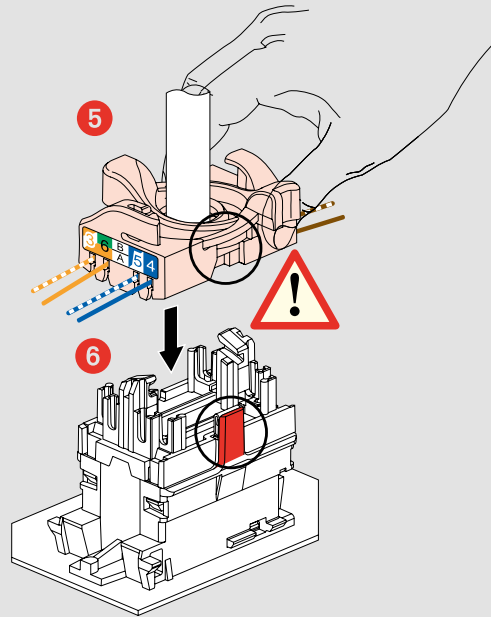

■ RJ45
7 67X 30/3740

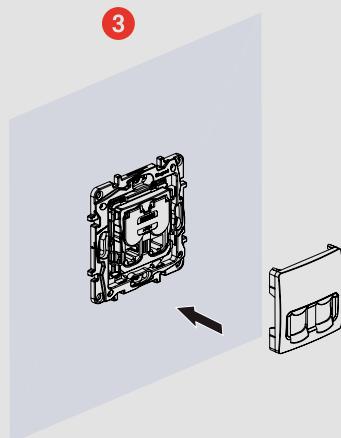
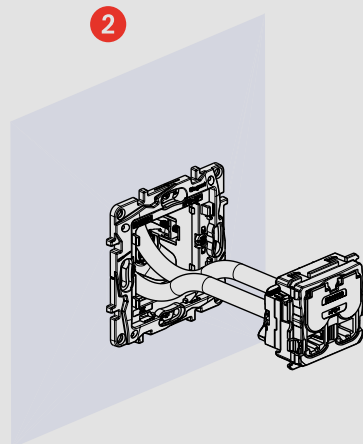
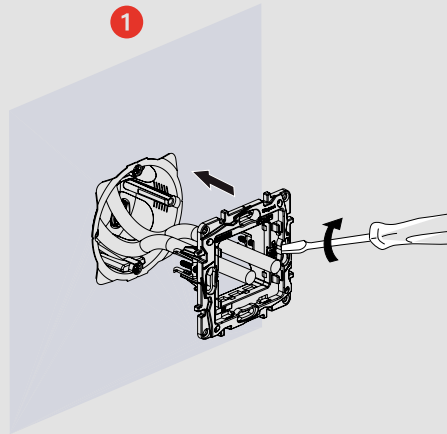

Çerçeve boyutları

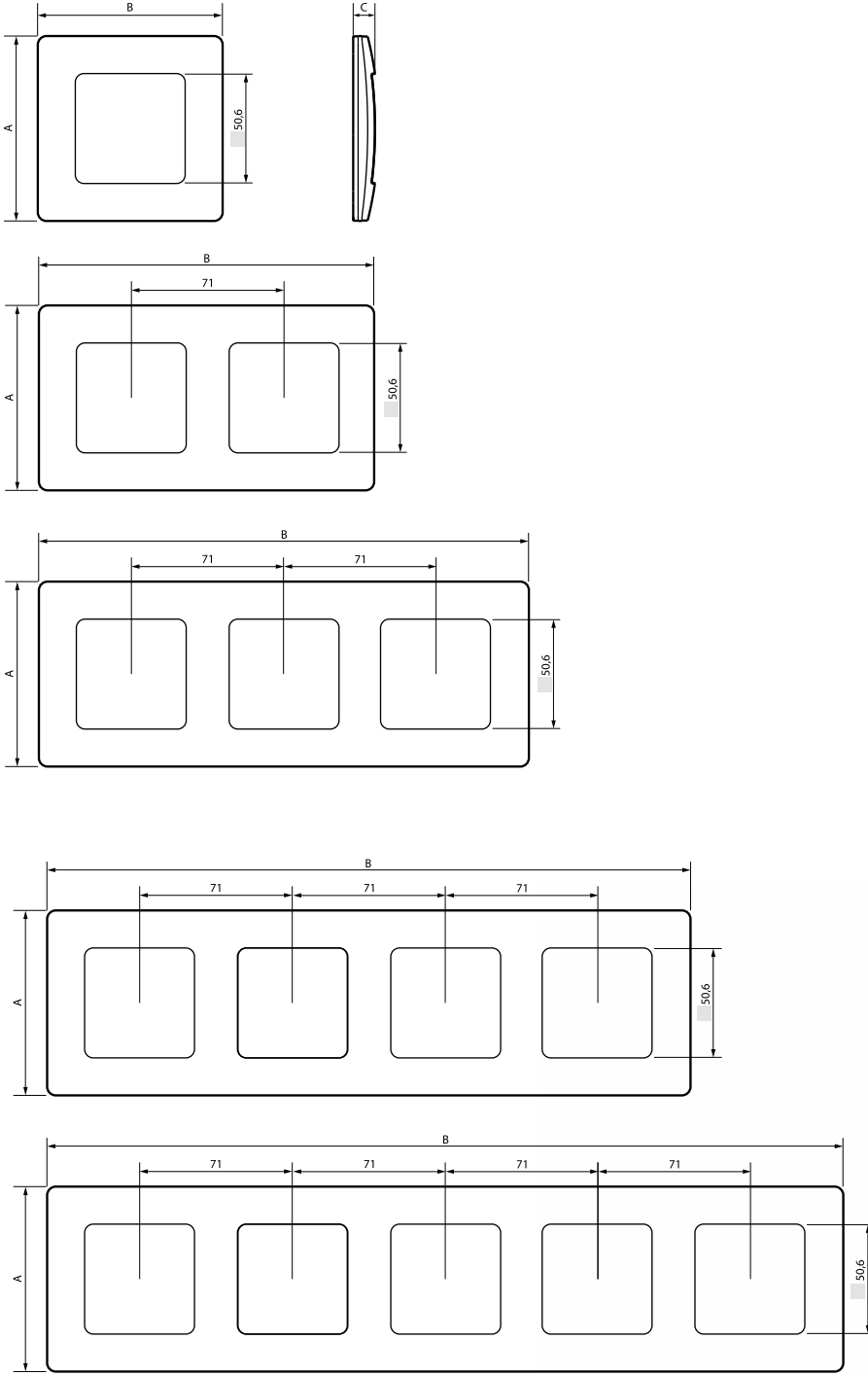

	A	B	C
Tekli çerçeve	86	86	10,15
2'li çerçeve merkezler arası 71mm	86	156	10,15
3'lü çerçeve merkezler arası 71mm	86	228	10,15
4'lü çerçeve merkezler arası 71mm	86	299	10,15
5'li çerçeve merkezler arası 71mm	86	370	10,15

Bölge Müdürlükleri

İstanbul Bölge Müdürlüğü

Kağıthane Ofis Park
Bağlar Caddesi No: 14
D1-D2 Kat: 5
34406 Kağıthane/İSTANBUL
Tel : (212) 368 28 00 (pbx)
(212) 251 34 30
Faks : (212) 251 52 95 - 249 39 91

Adana Bölge Müdürlüğü

Turhan Cemal Beriker Bulvarı
Gizerler İş Merkezi A Blok Kat: 3
No: 6
01110 ADANA
Tel : (322) 458 46 26 (pbx)
Faks : (322) 458 26 80

Ankara Bölge Müdürlüğü

Sanayi Cad. Çavuş sok, Akgül İşhanı
No: 3
D:10 06050 Ulus - ANKARA
Tel : (312) 310 92 14 - 310 82 15
(312) 309 18 32 - 309 18 33
Faks : (312) 312 28 88

Bursa Bölge Müdürlüğü

Üçevler mah. Bayraktepe sok.
Akay İş Merkezi No: 7 D: 5
Nilüfer - BURSA
Tel : (224) 443 28 00
(224) 443 01 03
(224) 443 01 04
Faks : (224) 443 01 05

İzmir Bölge Müdürlüğü

1203/11. Sokak Ömer Atlı
İş Merkezi No: 3 Kat: 7
D: 708-709 35110
Yenişehir - İZMİR
Tel : (232) 469 23 33
Faks : (232) 469 26 66

Karadeniz Bölge Müdürlüğü

Faks : (462) 229 99 54
GSM : (533) 296 62 59

Bölge Büroları

Antalya

GSM : (549) 748 88 12

Diyarbakır

Tel : (412) 235 74 83
Faks : (412) 235 74 83
GSM : (533) 968 16 79

Gaziantep

GSM : (533) 968 16 92

Konya

GSM : (549) 748 88 05

Samsun

GSM : (549) 748 87 94

Ücretsiz Teknik Danışma Hattı

0800 211 60 00

Pazartesi - Cuma saat:
08:00'den 17:30'a kadar

E-mail: info.turkiye@legrand.com.tr

website: www.legrand.com.tr



youtube.com/LegrandTurkiyeTV



facebook.com/LegrandTR



twitter.com/LegrandTR



LEGRAND ELEKTRİK SANAYİ A.Ş.
ELTAŞ ELEKTRİK MALZ. SAN. PAZ. A.Ş.

Fabrika - Merkez
GOSB Gebze Organize Sanayi Bölgesi
İhsan Dede Cad. No: 112
41480 Gebze - KOCAELİ
Tel : (262) 648 90 00 (pbx)
Faks : (262) 751 12 57 - 751 12 67