

LCS 3

3 DIMENSIONS OF EXCELLENCE

● PERFORMANCE ● SCALABILITY ● EFFICIENCY



DATA CENTER
LOCAL AREA NETWORK

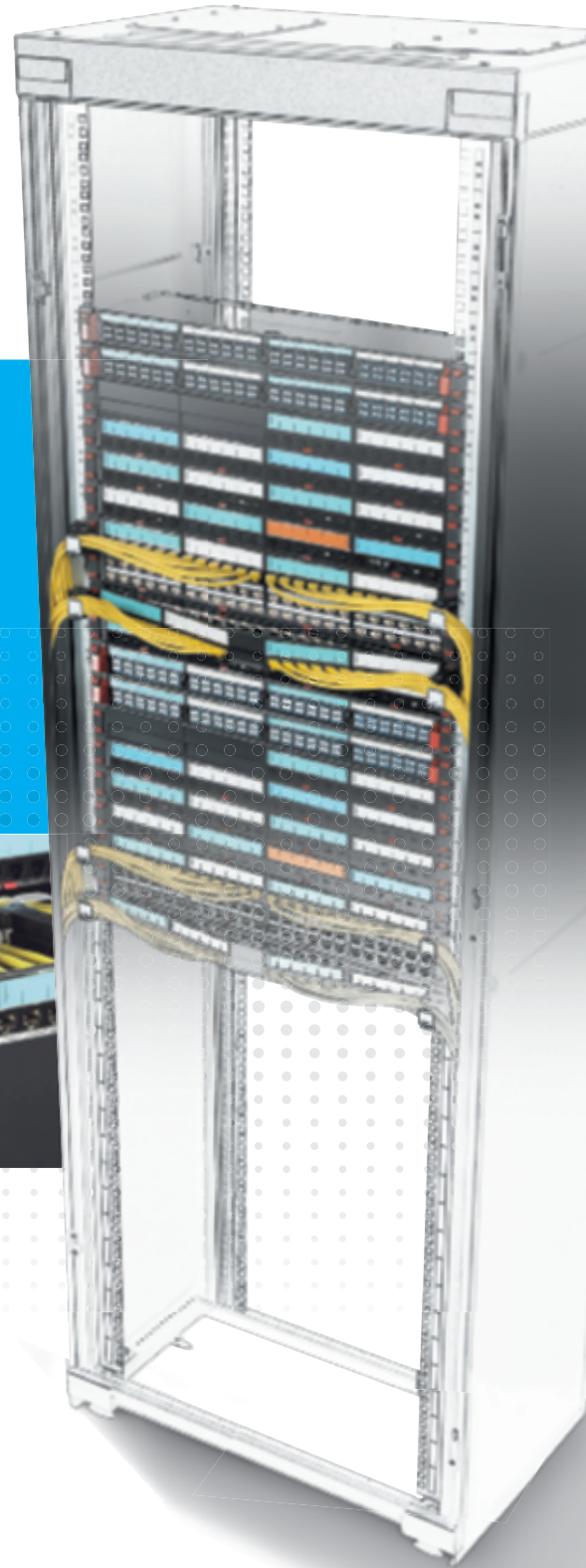

THE GLOBAL SPECIALIST
IN ELECTRICAL AND DIGITAL BUILDING INFRASTRUCTURES

 **legrand**[®]

LCS

3

3 DIMENSIONS
OF EXCELLENCE

● PERFORMANCE ● SCALABILITY ● EFFICIENCY



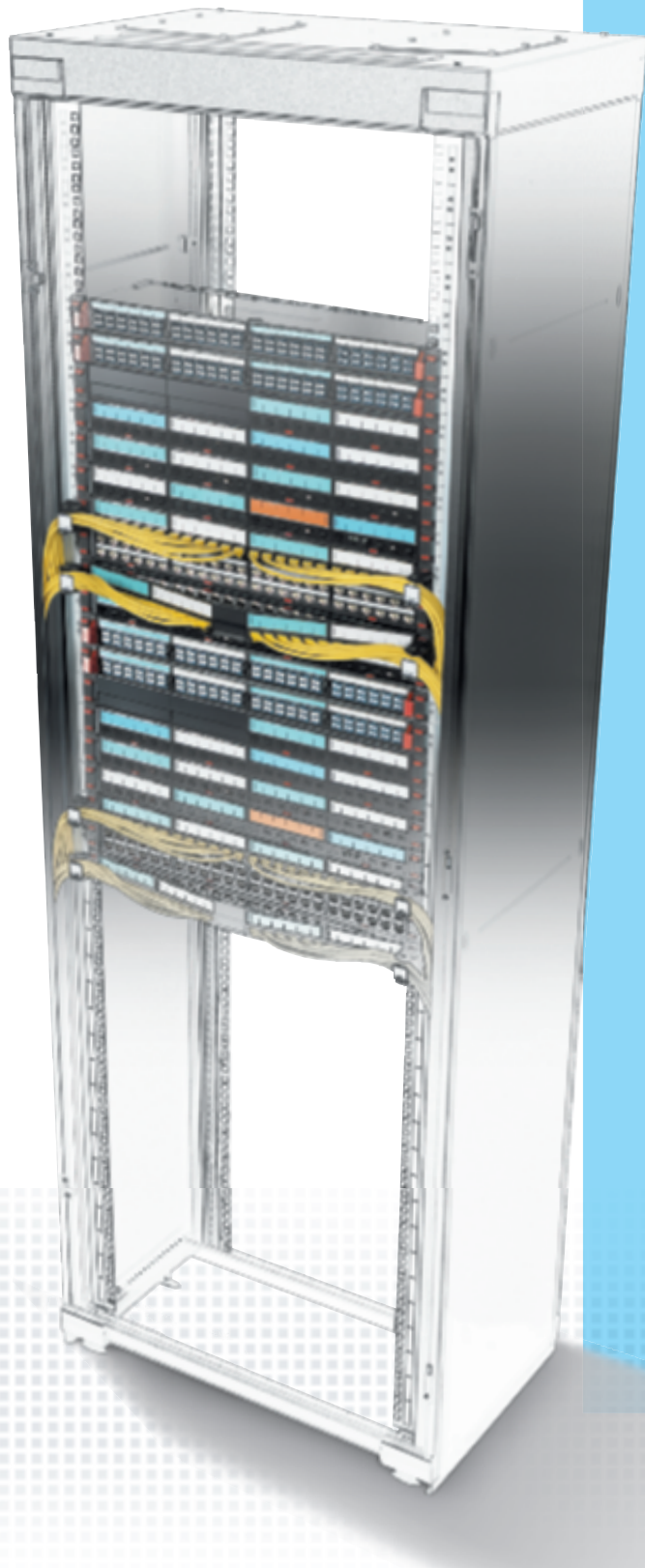

3 DIMENSIONS OF EXCELLENCE

◆ PERFORMANCE ◆ SCALABILITY ◆ EFFICIENCY

CONTENTS

- 4 Legrand - A global player
- 6 Legrand Group - A leading company for all your IT networks
- 8 Our digital infrastructure expertise
- 10 Easy installation
- 14 Scalability & Maintenance
- 22 Performance
- 26 Local Area Network
- 28 PDUs - Solutions for any configuration
- 30 Cord Locking System - Innovation at the heart of PDUs
- 32 ZERO-U PDUs - Innovation & performance
- 34 1U PDUs - Innovation & Convenience
- 36 Protection accessories
- 38 Support you can rely on
- 40 Evolution of standard 11801 Edition 3 - 2017
- 42 CPR - Construction Products Regulation



LCS

3

3 DIMENSIONS
OF EXCELLENCE

● PERFORMANCE ● SCALABILITY ● EFFICIENCY

Legrand

A global player

Legrand is the global specialist in electrical and digital building infrastructures. The Group offers a comprehensive range of solutions and services tailored to residential,

commercial and industrial applications. The scope of its offering and its leading positions make Legrand a worldwide benchmark.



4 KEY AREAS of expertise

From control and connection interfaces to cable management, energy distribution and data distribution systems, Legrand provides a host of solutions designed to manage lighting, energy, networks and building access.

AN ACTIVE INTERNATIONAL PRESENCE

ESTABLISHED
IN OVER
90 COUNTRIES

SALES IN
CLOSE TO 180
COUNTRIES

TURNOVER
€5 BILLION

OVER 36,000
EMPLOYEES

INNOVATION

4.9% OF SALES
INVESTED
IN R&D

A WIDE CHOICE
OF SOLUTIONS

OVER
230,000
CATALOGUE
ITEMS

80 PRODUCT
FAMILIES

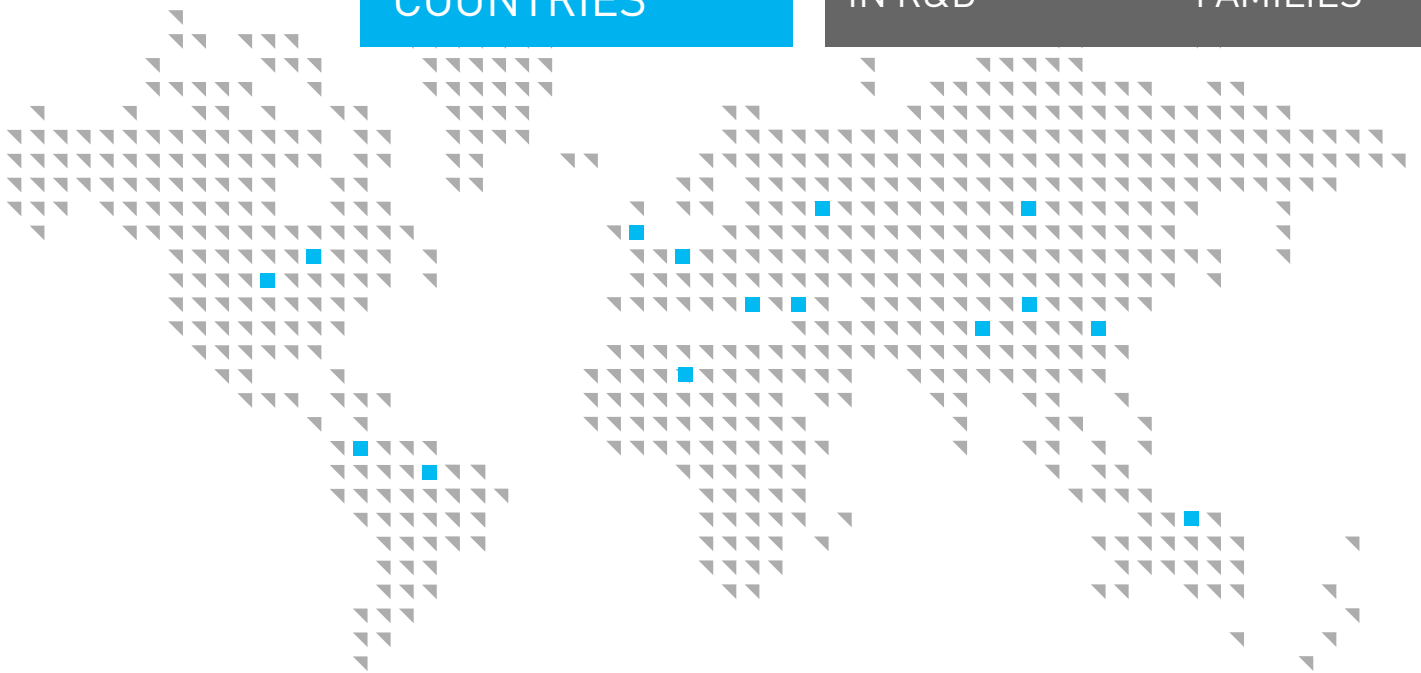

DIGITAL INFRASTRUCTURE

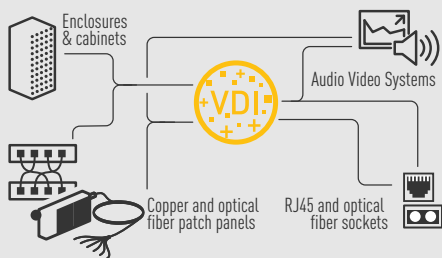

CONTROL AND COMMAND

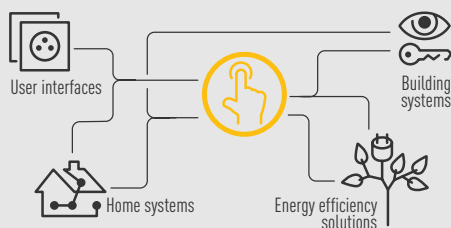

CABLE MANAGEMENT

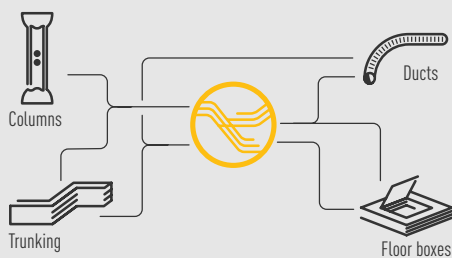

ENERGY DISTRIBUTION

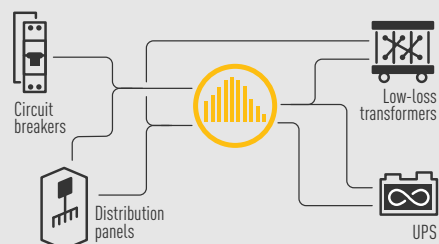



LCS

3

3 DIMENSIONS
OF EXCELLENCE

● PERFORMANCE ● SCALABILITY ● EFFICIENCY

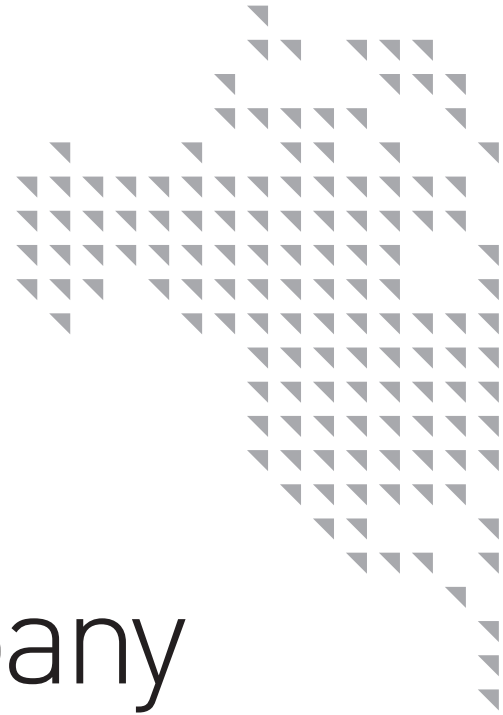

Legrand Group A leading company for all your IT networks

Legrand cabling systems currently provide high-quality connectivity to more than 200 million devices.

The Legrand Group is a world leader in communication networks for data transmission. Its investment in the

development and design of structured cabling systems and solutions has enabled it to expand its offer and achieve the highest level of performance. These solutions are ideal for today's multimedia networks, technologies and applications.

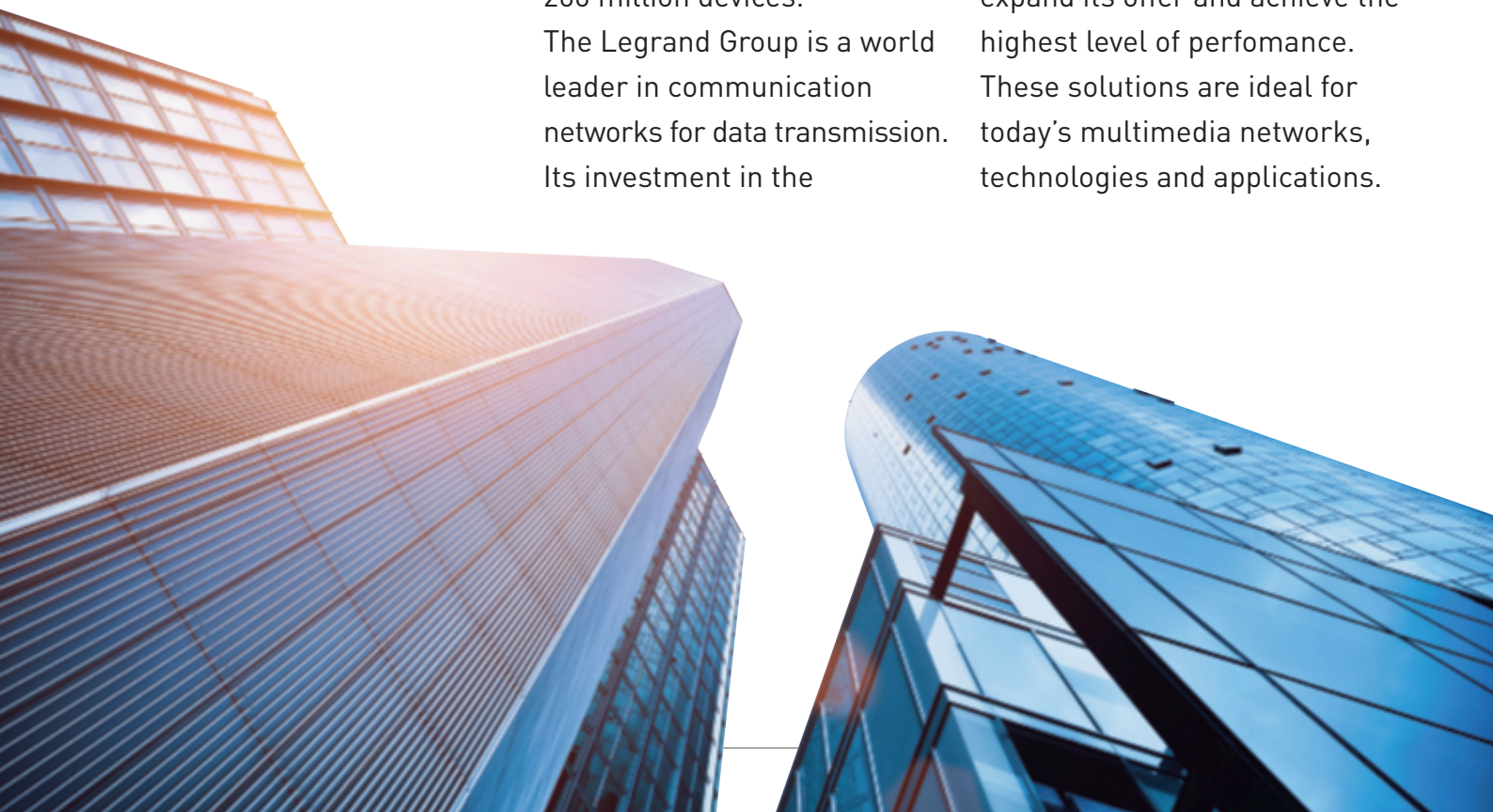

GLOBAL PLAYERS DATACOM IT

LEGRAND

Products and systems
for digital building
infrastructures.

A PORTFOLIO OF SPECIALIST BRANDS

- C2G • Electrorack • Estap • Middle Atlantic
- Minkels • Quicktron • Raritan • SJ Manufacturing • Valrack





Our digital infrastructure expertise

Legrand's complete global solutions for data communication perfectly address the key challenges for digital networks: performance, scalability and efficiency.



1

LOCAL AREA NETWORKS



SOLUTIONS FOR STRUCTURED CABLING

- **Housing solutions**
(19" freestanding and wall-mounting cabinets, open racks, PDUs, micro data centers, etc.)
- **Copper solutions**
(New Plug, controlled-access panel, controlled-access RJ45, etc.)
- **Fibre solutions**
(Connectors, equipped & modular panels, bend-insensitive cables, etc.)



2

DATA CENTER & SERVER ROOM

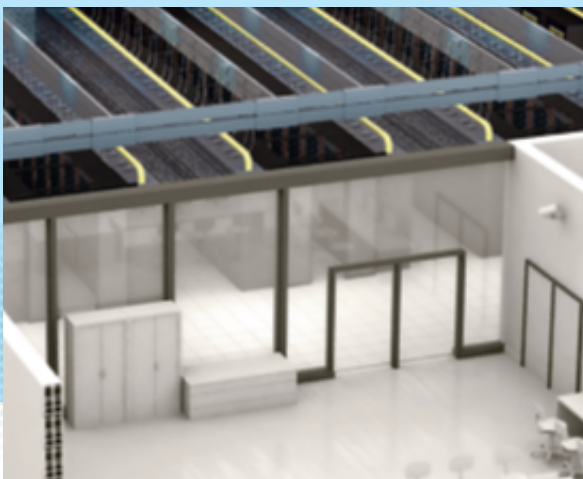

SOLUTIONS FOR STRUCTURED CABLING IN SERVER ROOMS

- **Housing solutions**
(Server cabinets, aisle containment, cooling units and cold corridor, open racks, PDUs, etc.)
- **Copper solutions**
(Preterminated, etc.)
- **Fibre solutions**
(Preterminated, intelligent patching, high-density fibre optic solutions, etc.)



3

AUDIO VIDEO SYSTEM



A WIDE RANGE OF TECHNOLOGIES TO SUIT THE LOCATION AND THE USER EQUIPMENT

- **Racks and enclosures**
- **Preterminated audio/video sockets**
(HDMI, display port, HD15, USB, RCA, JACK, etc.)
- **Cords and adaptors**



LCS

3 DIMENSIONS
OF EXCELLENCE

● PERFORMANCE ● SCALABILITY ● EFFICIENCY

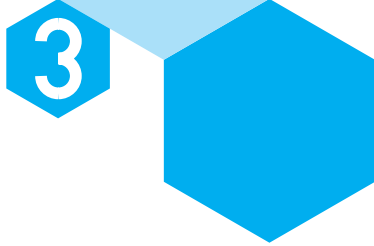

- 1 TOOLLESS
- 2 A PERFECT CONNECTION
- 3 FAST-ON CONNECTIONS IN PATCH PANEL

Easy installation

COPPER SYSTEM RJ 45 Connectors

The **NEW TOOLLESS CONNECTORS** with toolless fast connection are available in all categories for installation both on patch panels and in the workstation. A perfect connection can be obtained in a few seconds, guaranteeing optimum performance of the link from the patch panel to the workstation. They are colour-coded so their category can be safely identified:

- Cat. 5e: grey
- Cat. 6: blue
- Cat. 6 A: yellow
- Cat. 8: aqua

PATENTED
DESIGN

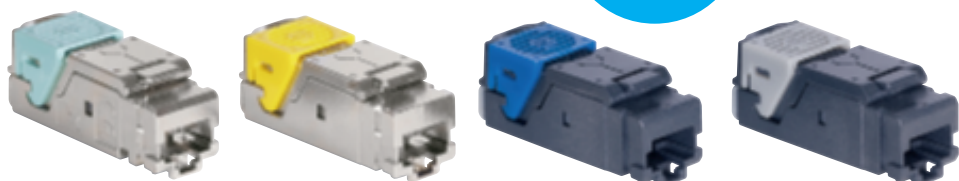

New systems to facilitate wiring and installation and increase the data transfer speed with both the copper solution and the fibre optic solution.

New Toolless connector connection phases

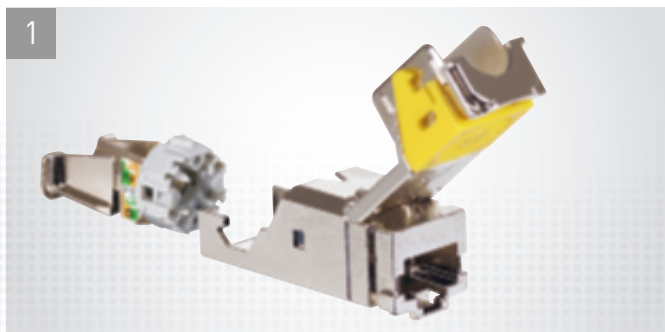

1 Take the wire housing

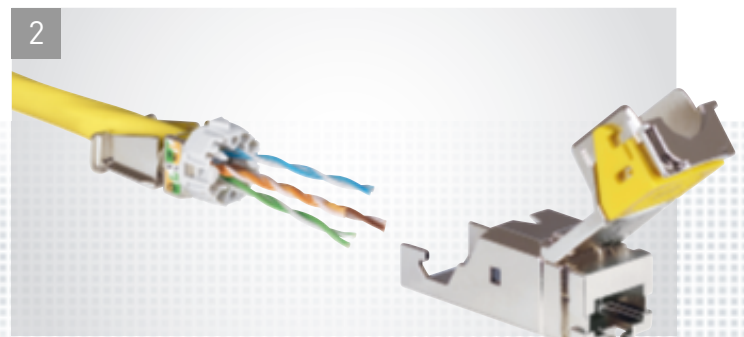

2 Pass the cable through the back of the wire housing

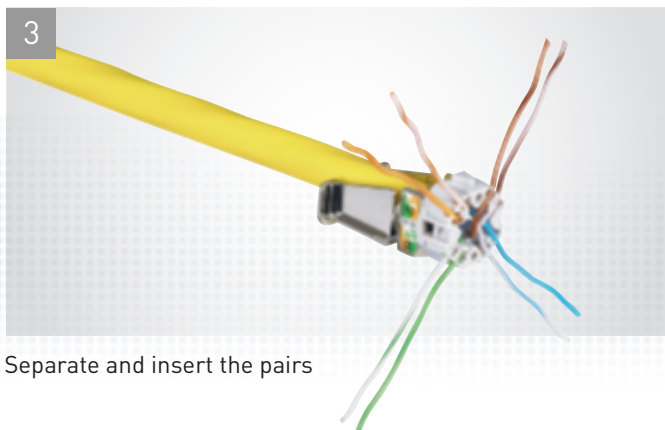

3 Separate and insert the pairs



4 Cut the pairs

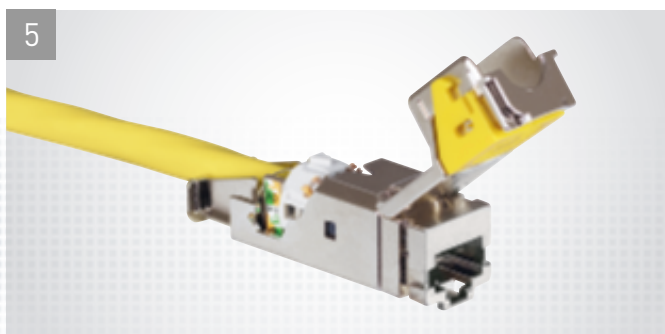

5 Install the wire housing without pushing

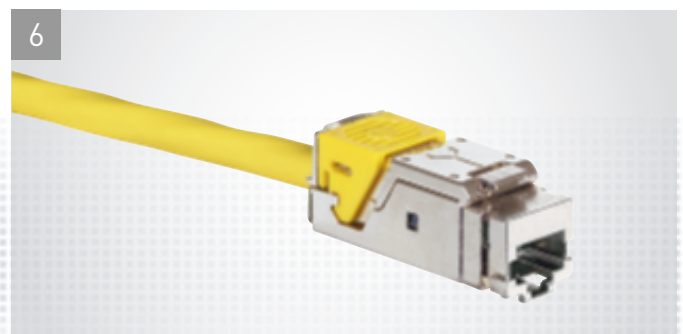

6 Push down the lever and lock the connector

LCS 3

Easy installation

Legrand has launched an innovative connection system to make simple, affordable fibre connections.

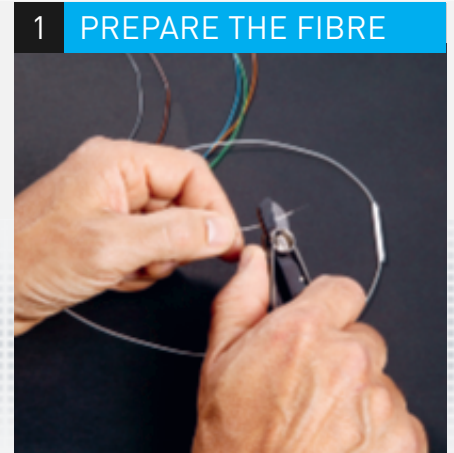

SMART SPLICER

- Easy to handle: one of the smallest tools in the market
- Easy to use: simple program with easy intuitive feedback
- Low cost: quick return on investment
- Best-in-class connection with 25-year warranty
- Legrand-coded pigtail connectors
- Pigtails: OM2, OM3, OM4, OS2, LC, SC, LC APC, SC APC

2 CLEAVE THE FIBRE



3 SPLICE THE FIBRE



4 PROTECT THE FIBRE (heat)



INSERTION LOSS LED

- GREEN: < 0.1 dB

- ORANGE: 0.1 dB < x < 0.2 dB

- RED: > 0.2 dB





LCS

3 DIMENSIONS
OF EXCELLENCE

● PERFORMANCE ● SCALABILITY ● EFFICIENCY

3

1

SLIDING CASSETTE:
EASIER MAINTENANCE

2

INNOVATIVE MODULAR
CASSETTE SYSTEM

3

FAST PUSH-BUTTON
EXTRACTION

New systems to facilitate wiring and installation and increase the data transfer speed with both the copper solution and the fibre optic solution.

Scalability & Maintenance

COPPER SYSTEM Patch Panels

The new patch panels have been designed and produced to optimise space, with up to 48 ports per unit, and make maintenance and future upgrades easier. They are available in both flat and angled versions. They have a quick system for pulling out the unit and an innovative cable guiding system for tidy and easy cable management.

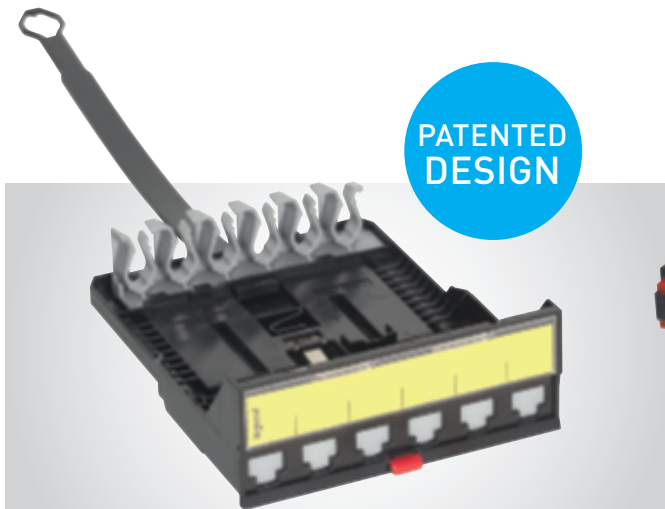

Cassette up to 12 connectors for patch panel

- Sliding cassettes: easier maintenance
- Fast push-button extraction
- Innovative modular cassette system
- Easy maintenance: Remove connectors without disconnecting the cords
- **Easy to mix with Legrand fibre optic solutions**



48 ports per unit

New QUICK-FIX system



Innovative new quick-fixing solution:

- Push and connect system
- Automatic earth connection
- In-rack cabling optimised
- New accessory for patch cords with rotating system for angle adjustment and label holder

**Compatible with all panels
(Flat, angled, HD)**

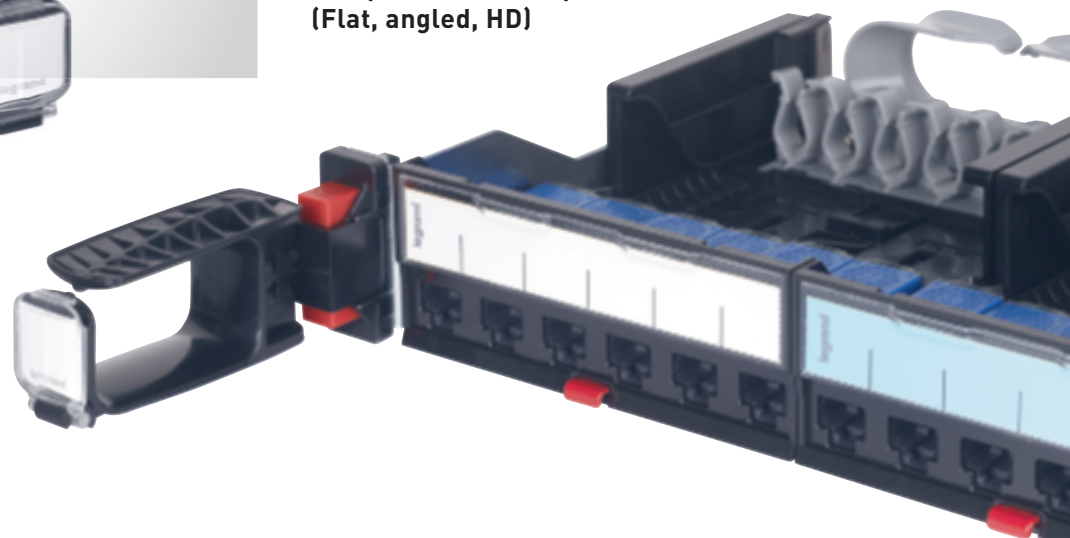

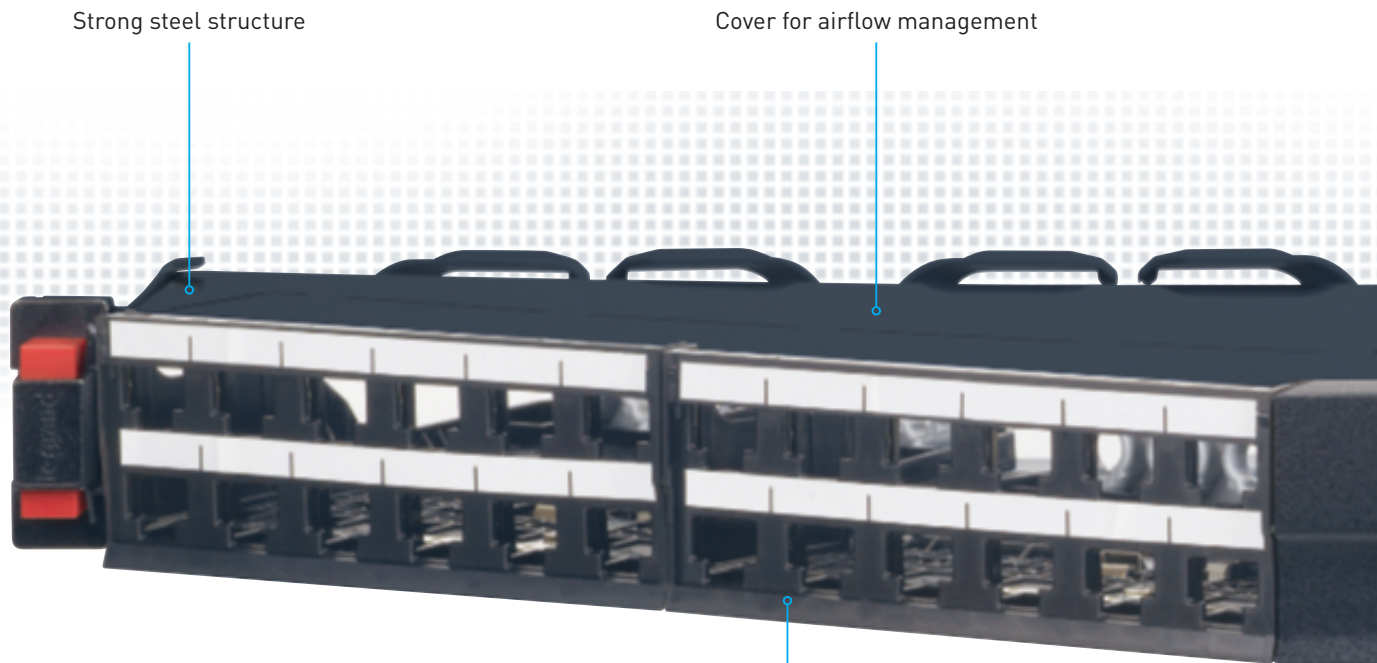

Strong steel structure

Cover for airflow management

High density - This supplies up to 48 ports in a single unit to take up less space in the rack

Angled patch panel solution from 24 to 48 ports per unit

Patch panels with an angled design which allow the cable to run into each side of the rack, creating a correct cable radius of curvature. This avoids the need to manage the cables horizontally, and allows the patch cords to be carried directly in the vertical cavities.



Tidy cable management

Quick-fix system

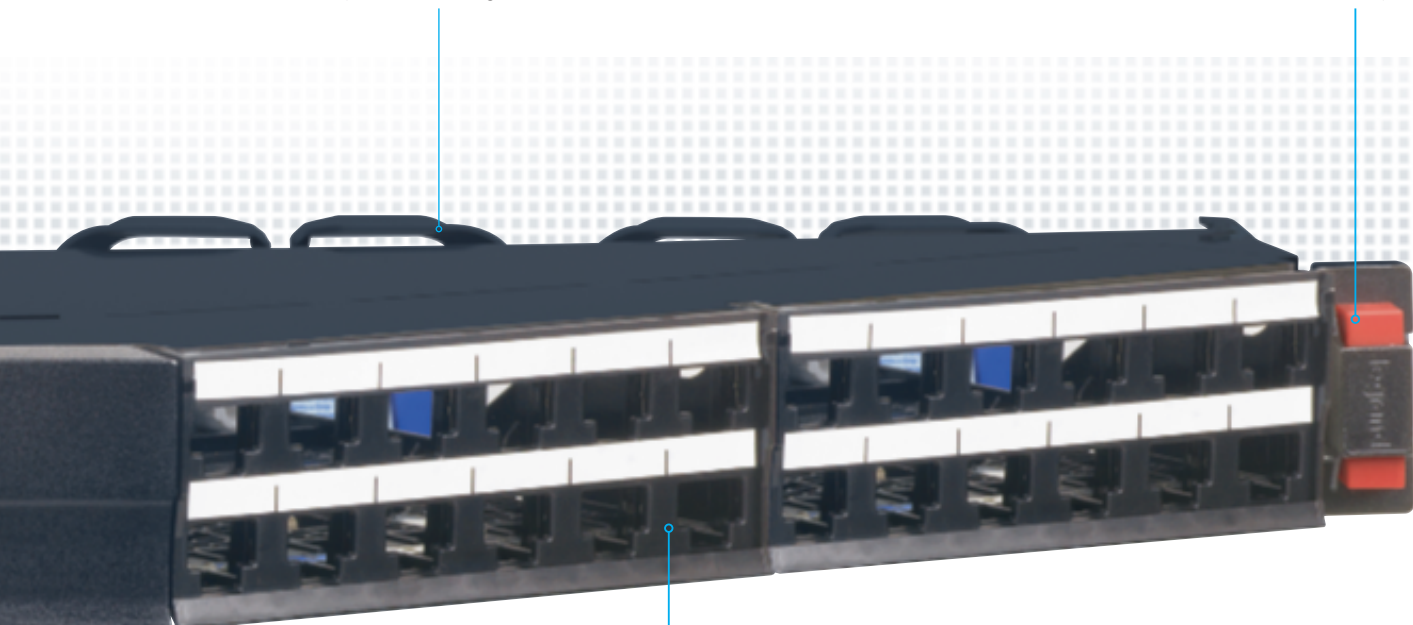

Simple and efficient
Identification of the ports



Also available
in the 24-port version

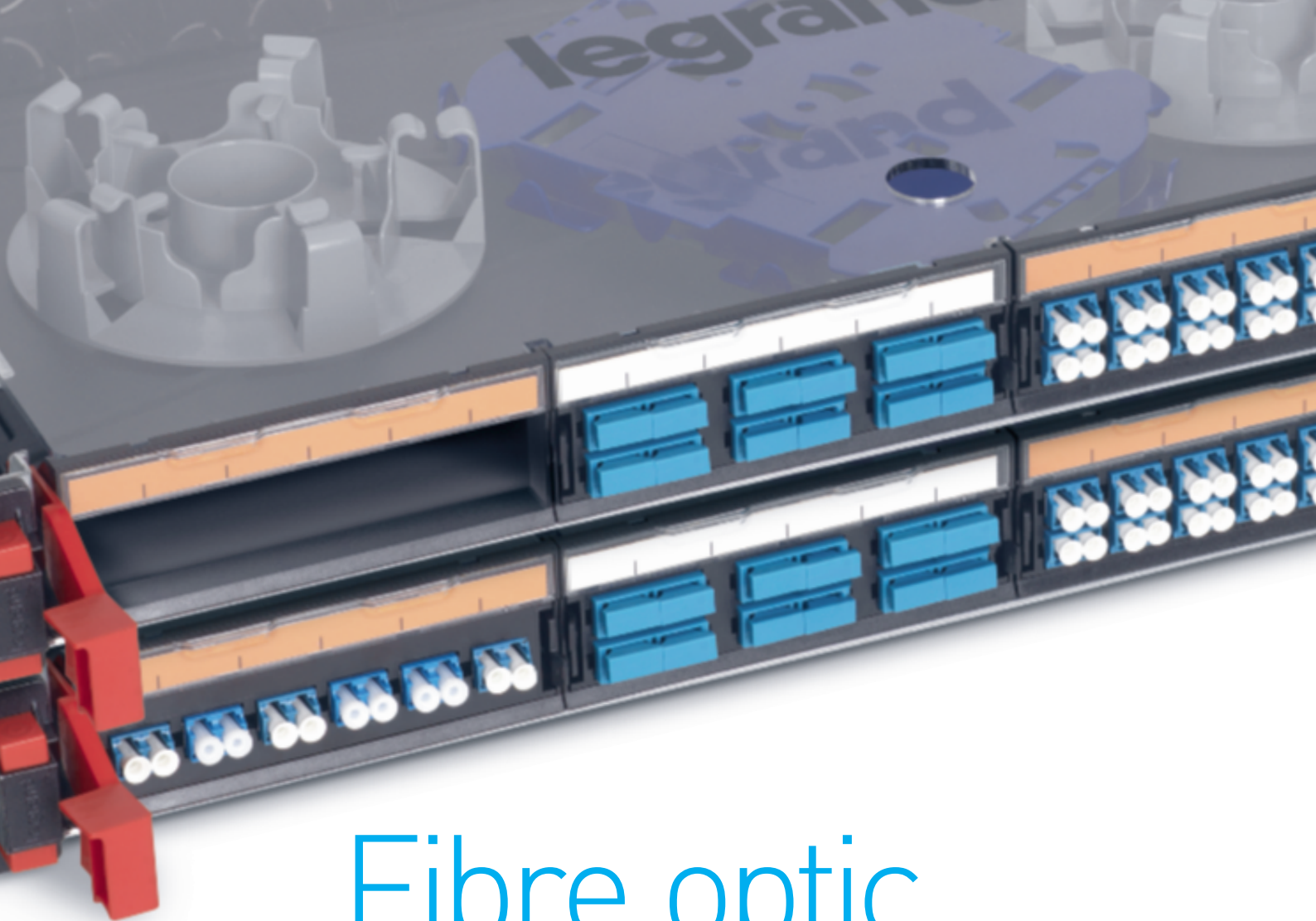

Fibre optic panels

Completely renovated and redesigned fibre optic panels & drawers in high and very high density versions from 96 connectors per unit to 144 connectors per unit. Panels with sliding drawers and fast push-button system to facilitate upgrade and maintenance operations.

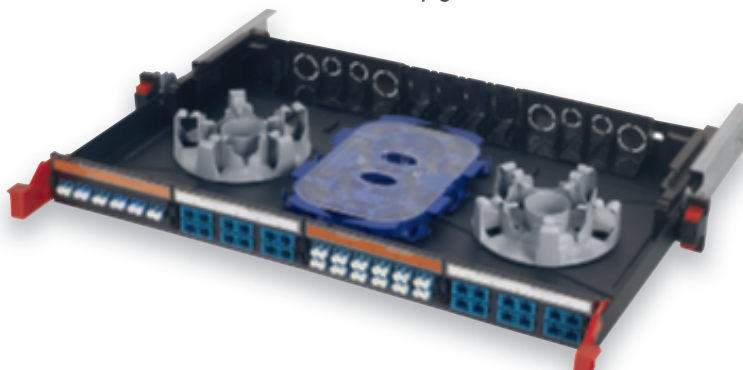

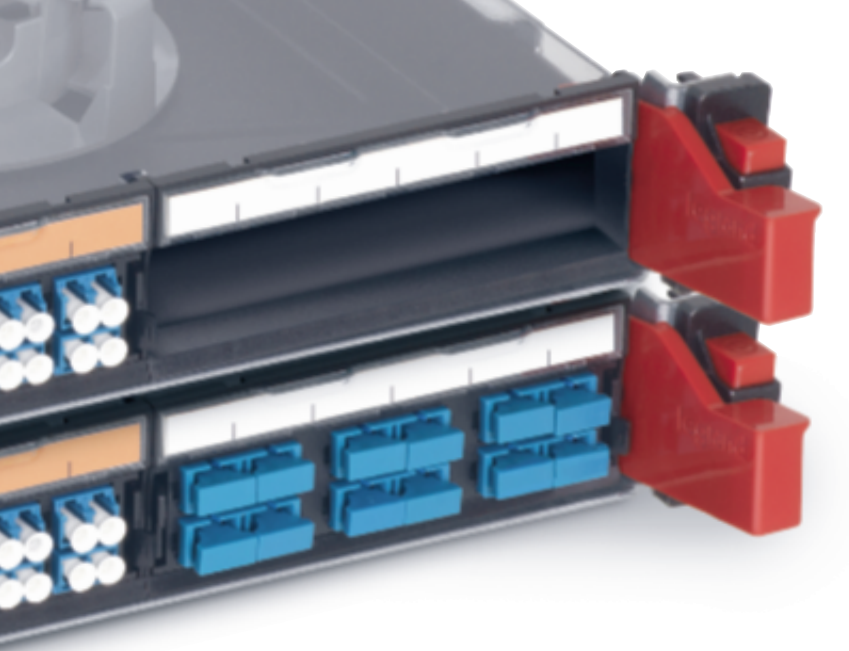

MODULAR PANELS

- Possible to change modular blocks, blank panel, MTP adaptor
- Splice trays to be added if necessary - up to 4 containing 96 LC fibres

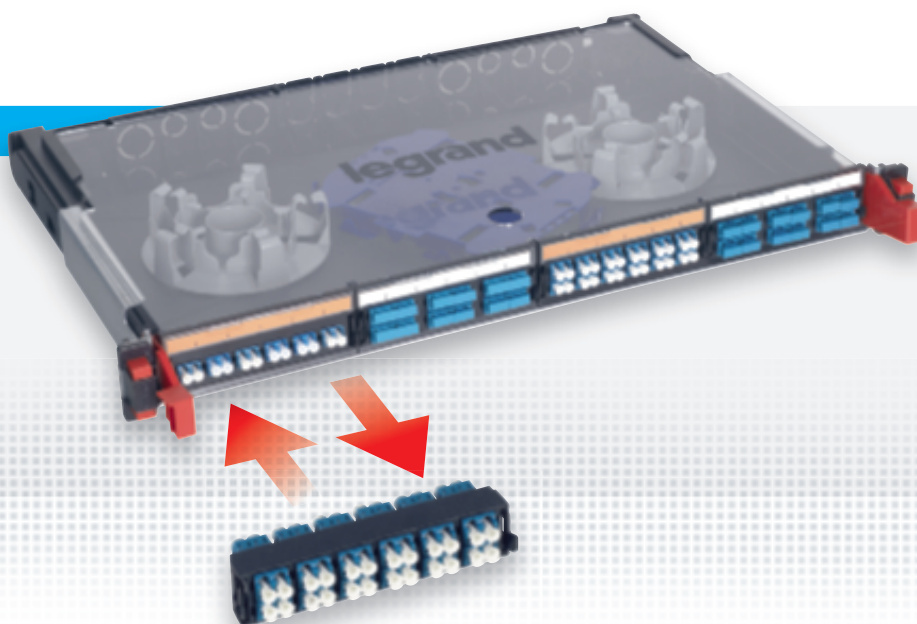

HD MODULAR PANELS

- Innovative new quick-fixing solution
- Possible to add splicing cassette with perfectly adapted coiling space
- Mix of fibre/copper on modular panel in drawer

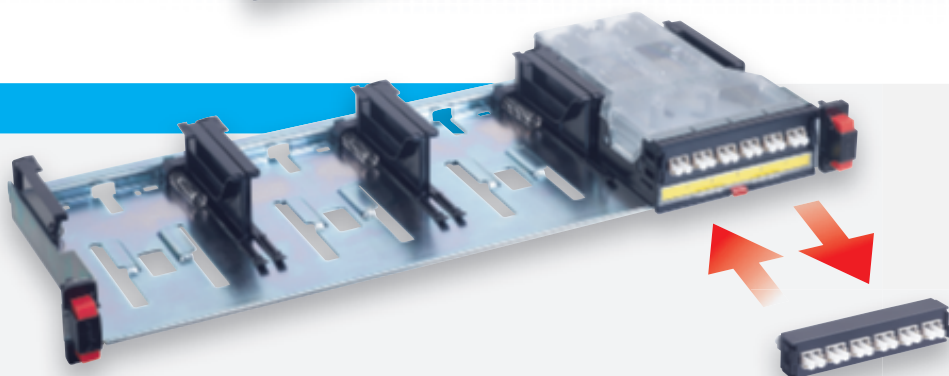

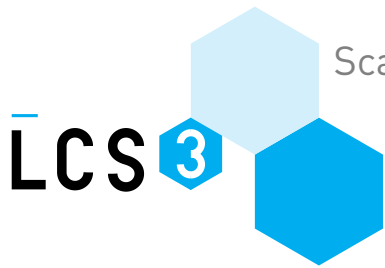

Scalability & Maintenance

Fibre optic panels

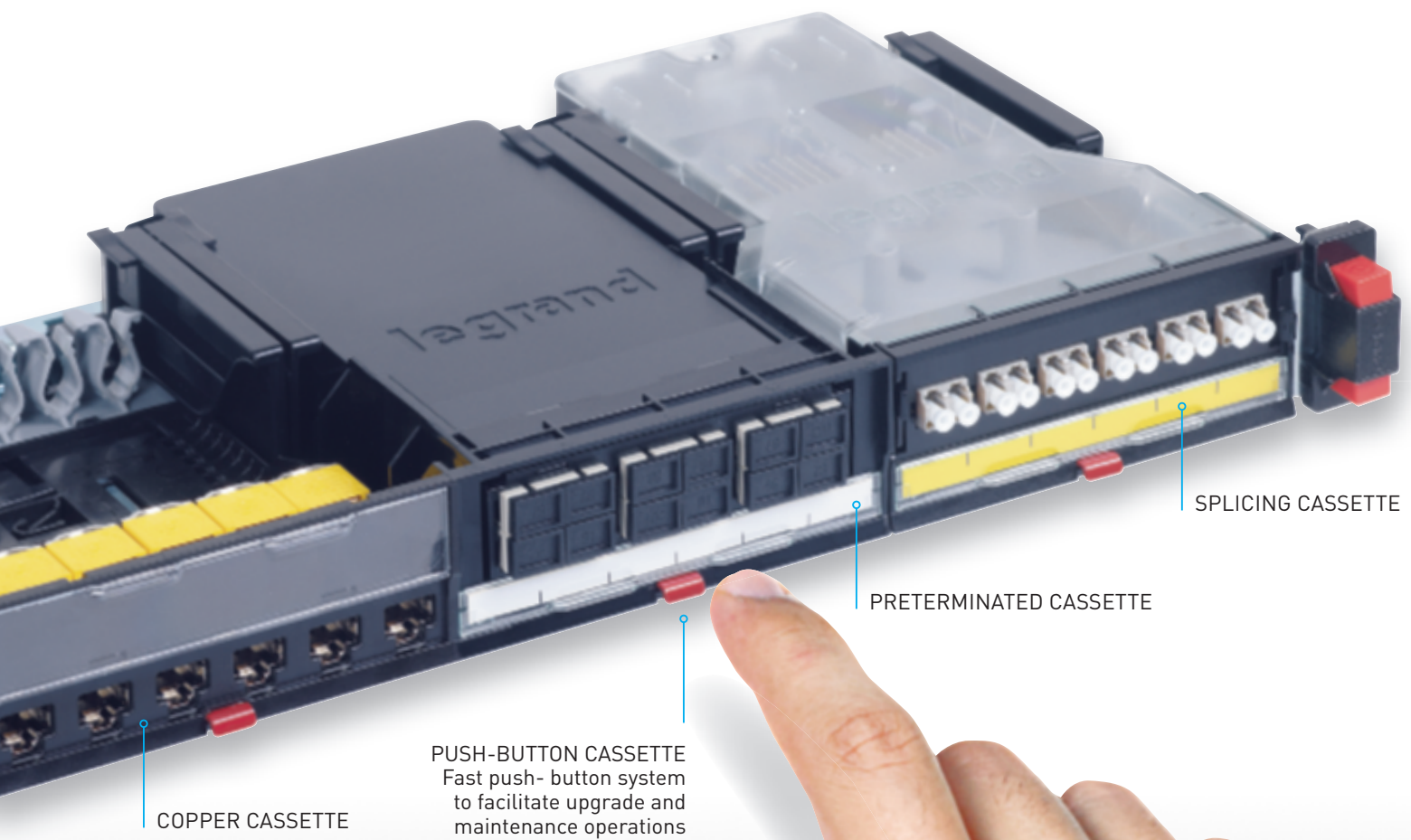



MODULAR PANELS

- Innovative new quick-fixing solution
- Modular blocks to adapt to modular panel or drawer: LC, SC, ST, LC, APC, SC APC
- Possible to add modular blocks, blank panel, MTP adaptor

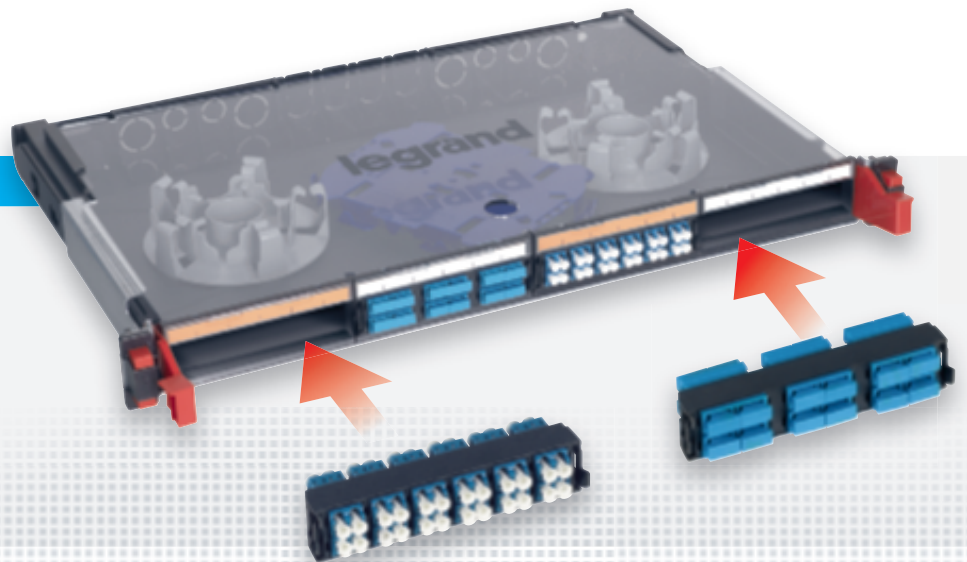

HD MODULAR PANELS

- Cassettes slide in from front & rear
- Fast push-button on cassette
- Splicing cassette which takes all modular blocks
- Mixture of fibre/copper on cassette panel
- Trunk & cord management system

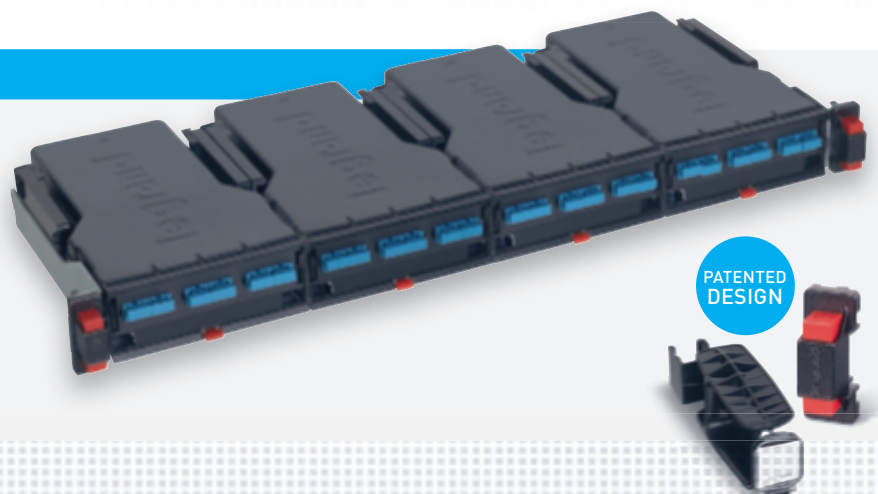

LCS³

3 DIMENSIONS
OF EXCELLENCE

● PERFORMANCE ● SCALABILITY ● EFFICIENCY

Performance

When describing the performance of a structured cabling system, irrespective of the technology used for the conductor (copper or fibre optic), the transmission speed (Bit rate) is the reference point.

Legrand's LCS³ system offers you

- 1** 25 Gbps and 40 Gbps Ethernet applications
COPPER SYSTEM
- 2** 40 Gbps and 100 Gbps Ethernet applications
FIBRE OPTIC SYSTEM
- 3** MTP/MPO high density and up to Cat. 8 solutions
FIBRE OPTIC & COPPER SYSTEMS

COPPER SYSTEM

The cable is one of the most critical components in horizontal wiring for the performance of the whole link, in terms of both quality of the product and conformity of the installation.

Any cable installation error will seriously compromise performance of the installation.

For structured cabling systems, the standard requires the use of category 5e, 6 and 6_A (100 MHz, 250 MHz and 500 MHz respectively) twisted, symmetrical 4-pair cables with an impedance of 100 Ω¹⁾.

The cable can be of the following type:

- Unshielded U/UTP (Unshielded Twisted Pairs)
- Shielded F/UTP (Foiled Twisted Pairs)
- Double shielding SF/UTP or S/FTP.

NOTE 1): To date, category 7 is not very widely used, even though it is standardised and can offer high performance levels. It is used for reasons of form factor, cost and where there are installation difficulties.

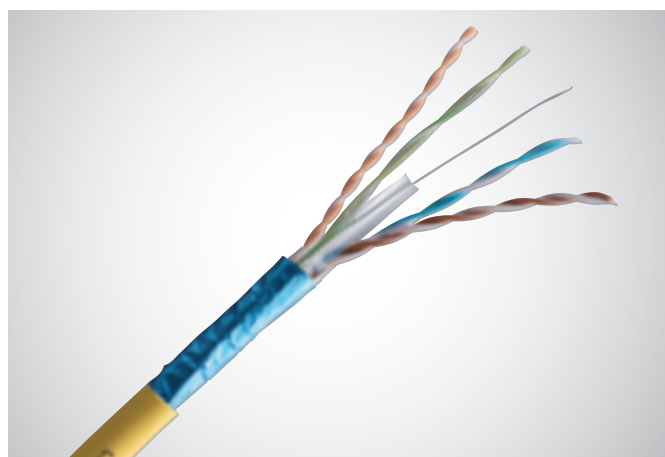

Legrand cable solutions

	Sheath	Marking	Storage/installation temperature	Operating temperature
Cat. 6_A F/UTP 100 Ω	LSZH (zero halogen cables) conforming to standard NFC 32062, flame retardant conforming to standards IEC 332-1 and NFC 32070 2.1 - Ø 7.8 mm - Colour: RAL 1018 yellow	LEGRAND 32778 4 pairs 24 AWG F/UTP 100 ohms LSZH Cat. 6a 500 MHz - CHECKED AGAINST ISO 11801 IEC 332-1 EN 50173 - TIA 568B - VPN/NVP% Batch no. + length in metres	0 to +50°C	-20 to +60°C
Cat. 6 U/UTP 100 Ω	PVC or LSZH cables conforming to standard NFC 32062, flame retardant conforming to standards IEC 332-1 and NFC 32070 2.1 - Ø 6.4 mm - Colour: RAL 5015 blue	LEGRAND (4 pairs or 2x4 pairs) 24 AWG UTP 100 ohms 250 MHz (PVC or LSZH) Cat. 6 250 MHz - CE CHECKED AGAINST ISO 11801 IEC 332-1 EN 50173-1 TIA 568A Batch no. + length in metres	0 to +50°C	-20 to +60°C
Cat. 6 F/UTP 100 Ω	PVC or LSZH cables conforming to standard NFC 32062, flame retardant conforming to standards IEC 332-1 and NFC 32070 water-repellent synthetic tape - Ø 7 mm - Colour: RAL 5015 blue	LEGRAND (4 pairs or 2x4 pairs) 24 AWG FTP 100 ohms 250 MHz (PVC or LSZH) Cat. 6 250 MHz - CE CHECKED AGAINST ISO 11801 IEC 332-1 EN 50173-1 TIA 568A Batch no. + length in metres	0 to +50°C	-20 to +60°C
Cat. 5e U/UTP 100 Ω	PVC or LSZH cables conforming to standard NFC 32062, flame retardant conforming to standards IEC 332-1 and NFC 32070 2.1 - Ø 5.2 mm - Colour: RAL 7035 light grey	Cat. No. LEGRAND (4 pairs or 2x4 pairs) 24 AWG UTP 100 ohms (PVC or LSZH) Cat. 5e CE CHECKED AGAINST ISO 11801, IEC 332-1, EN 50173-1, TIA 568A Batch no. + length in metres	-15 to +70°C	+5 to +40°C

NOTE: For all other types of cable, please contact the Legrand sales network

FIBRE OPTIC SYSTEM

Fibre optic is a transmission medium that enables a larger bandwidth to be used than copper cables. With fibre optic cables, transmission is based on the propagation of light pulses, generated by an LED or a laser source in the infrared band, along a glass fibre. Inside an optical fibre, the signal can either be propagated in a straight line, or be reflected many times. Straight line propagation mode is said to be zero order. Singlemode fibres only use one mode to propagate light. The diameter of their cores is between 8 and 10 μm . Multimode fibres allow several propagation modes, and the diameter of their cores is 50 μm or 62.5 μm (the latter is hardly ever used now). The diameter of the cladding is usually 125 μm . Multimode fibres are used in indoor installations and enable more economical devices to be used. They are however subject to the phenomenon of modal distortion, when the different modes propagate at slightly different speeds, which limits the maximum distance at which the signal can be received correctly. Singlemode fibres are used in outdoor installations as they can cover much longer distances and reach much higher speeds.



Diagram of a single-fibre cable

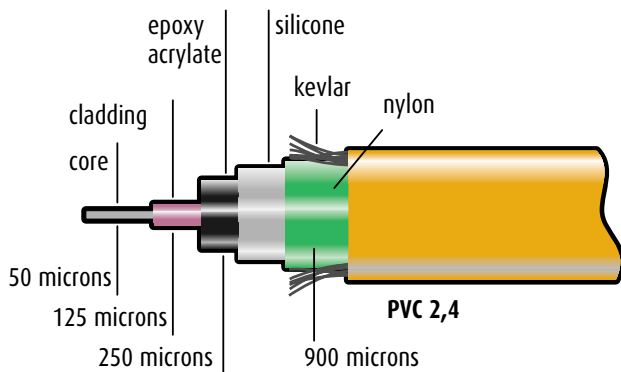

Exploded view of a multifibre cable containing 6 single fibres

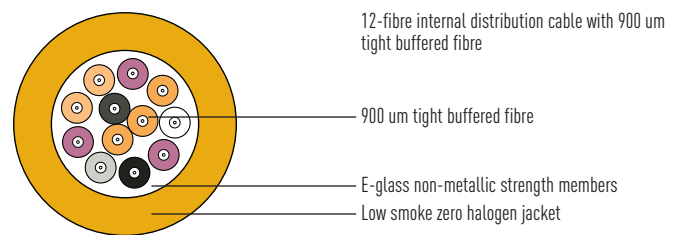

Multimode optical fibre

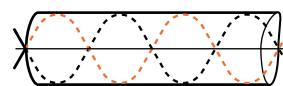



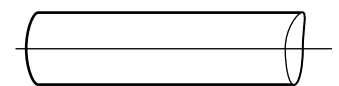

Diameter of the core: 50-62.5 μm
Diameter of the cladding: 125 μm

Singlemode optical fibre

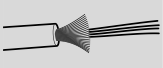
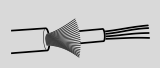

Diameter of the core: 8 to 10 μm
Diameter of the cladding: 125 μm

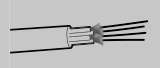
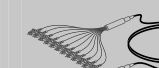
Performance across the system with on-demand preterminated solutions

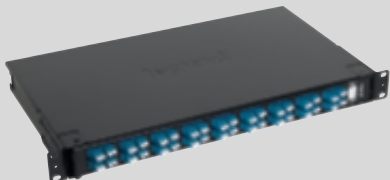
Connectivity	Standard density (HD)	Modular density (HD)
Trunks	<p>TYPE</p> <div style="display: flex; justify-content: space-around;"> <div style="text-align: center;"> <p>Tight Buffer</p>  </div> <div style="text-align: center;"> <p>Loose Tube</p>  </div> <div style="text-align: center;"> <p>Loose tube corrugated steel tape</p>  </div> </div> <div style="display: flex; justify-content: space-around; margin-top: 20px;"> <div style="text-align: center;"> <p>TYPE OF FIBRE OS1/OS2, OM1, OM2, OM3, OM4, etc.</p> </div> <div style="text-align: center;"> <p>NUMBER OF FIBRES 2, 4, 6, 8, 12, 16, 24, On demand, etc.</p> </div> </div>	<div style="display: flex; justify-content: space-around;"> <div style="text-align: center;"> <p>Breakout</p>  </div> <div style="text-align: center;"> <p>Fan-out</p>  </div> <div style="text-align: center;"> <p>Micro-cable 250 microns</p>  </div> </div> <div style="display: flex; justify-content: space-around; margin-top: 20px;"> <div style="text-align: center;"> <p>CHOICE OF TERMINATION LC, SC, SC APC, MTP etc.</p> </div> <div style="text-align: center;"> <p>PLEASE CONTACT US for any specific requirements.</p> </div> </div>
	<p>Panels & cassettes Splice panel</p>	
<p>Cables/Patch cords</p>	<p>OM2, OM3, OM4 & OS2</p>	<p>OM3, OM4 & OS2</p>

LCS

3

3 DIMENSIONS
OF EXCELLENCE

● PERFORMANCE ● SCALABILITY ● EFFICIENCY

Local Area Network

LCS³ CONNECTIVITY RACK

Mighty Mo 20 4-post racks provide greater flexibility and optimum efficiency in any data center. The fixed racks provide an economical mounting platform for switches and servers while the adjustable rack allows all 4 mounting rails to be adjusted even after the rack

has been fastened to the floor. Front and rear waterfalls allow for equipment patching and server patching. All styles of Mighty Mo 20 vertical manager can be mounted front or rear, and airflow baffles can be mounted to manage the airflow of side-breathing equipment.

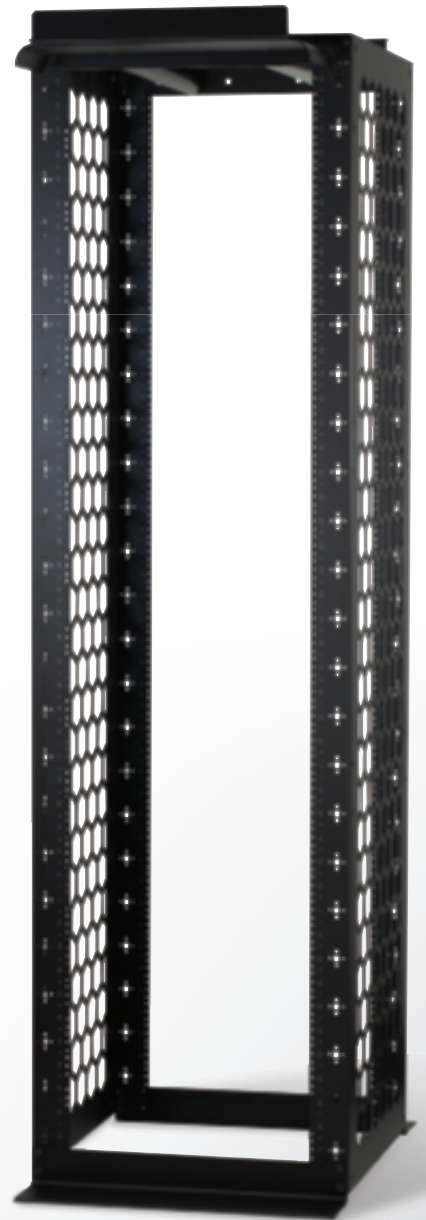



LCS³ CABLING RACK

Given how quickly IT technology evolves, a flexible, future-proof concept is essential. The LCS³ cabling rack is specifically designed to meet these needs and stands out due to its versatility, ease of installation and ease of use.

The LCS³ cabling rack is a multifunctional system, specifically designed for ease of installation. The system is ultimately suitable for housing UTP-patch panels, glass drawers, telephone panels, switches, routers and other IT equipment. Of course it is also possible to include a small number of servers.



LCS³ WALL ENCLOSURE

The basic frame is made up of a wall-mounting plate with integrated strain relief bar, four depth rails, two cable-entry plates (base and top) and a set of 19-inch rails. The assembly consists of two equal top and base panels with ventilation slots to the rear, two equal side panels and a safety glass door with an EK-333 cylinder lock with grip.

PDU's

Solutions for any configuration

A wide universal range

This new PDU offer combines Legrand's quality and innovation with a wide range of applications. A standalone solution, this range integrates seamlessly into any installation and ensures compliance with applicable standards.

GENERAL CHARACTERISTICS

- Anodised aluminium body:
Lightweight rigid high-end material
- Modular design:
Expandable outlet and function modules

SAFETY

- High electrical safety rating
- High-quality connection
- Outlets equipped with safety shutter

• Cord Locking System



POWER SUPPLY

- 16 A to 32 A single-phase or three-phase
- PDUs integrate local and international outlet types



STANDARDS

IEC 60950 - Information technology equipment – Safety

IEC 60297-3 - Dimensions of mechanical structures of the 482.6 mm (19 in) series

IEC 60320-2-2 - Interconnection couplers (C13 and C19) for household and similar equipment

IEC 60884-1 - Plugs and socket outlets for household and similar purposes (France, Belgium and Germany)

BS 1363-2 - British standard plugs and socket outlets

IEC 60309 - Plugs, socket outlets and couplers for industrial purposes

Certification: CE, TSE, CCC

Environmentally-friendly products

Eco-friendly design



ZERO-U PDUs



FOR DATA CENTERS/SERVER ROOMS

Used in server cabinets where:

- there is a high density of active equipment
- electrical distribution quality is crucial

12 CATALOGUE NUMBERS

FOR VERTICAL INSTALLATION

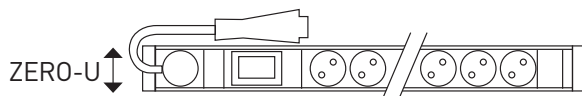

19" 1-U PDUs



FOR DATA CENTERS/SERVER ROOMS AND COMPUTER ROOMS

Used in server and cabling cabinets where:

- there is a low density of active equipment to be powered
- ease of installation is an advantage

26 CATALOGUE NUMBERS

FOR VERTICAL OR HORIZONTAL INSTALLATION

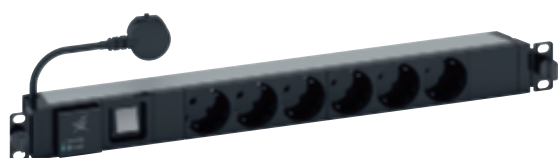
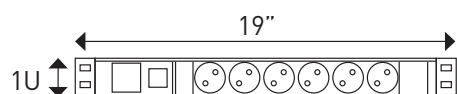

10" 1-U PDUs



FOR SMALL IT ENVIRONMENTS

Mainly used in small-scale commercial applications where there is a limited number of IT points and a 10" cabinet is sufficient:

- Small businesses, freelance professions, administrative services, etc.

3 CATALOGUE NUMBERS

HORIZONTAL PDU

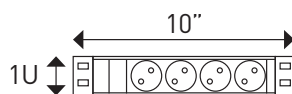



Cord Locking System

Innovation at the heart of PDUs

For C13 & C19 sockets

A major addition to the range and exclusive to Legrand, C13 and C19 outlets have a power supply cord locking system which prevents accidental disconnection and guarantees absolute safety.

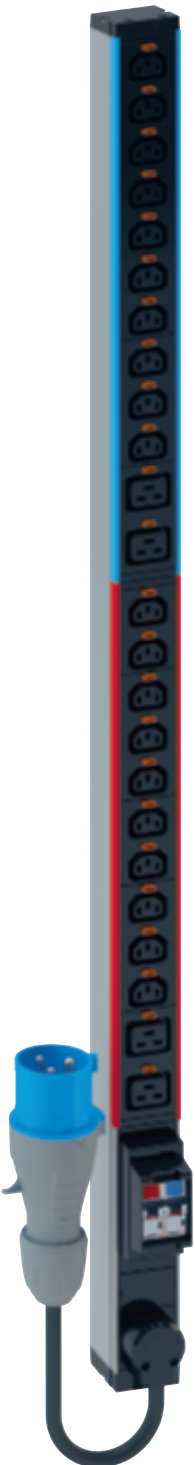

AN INNOVATIVE TECHNICAL SOLUTION



CORD LOCKING SYSTEM

Very easy to identify thanks to the orange buttons next to each outlet

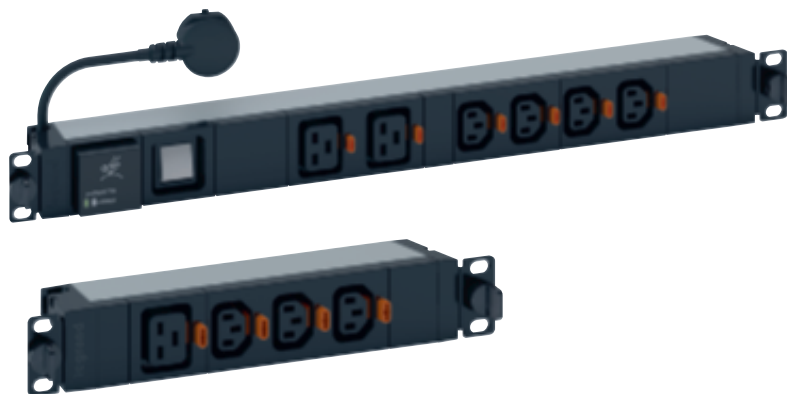



1 CONNECTION ✓

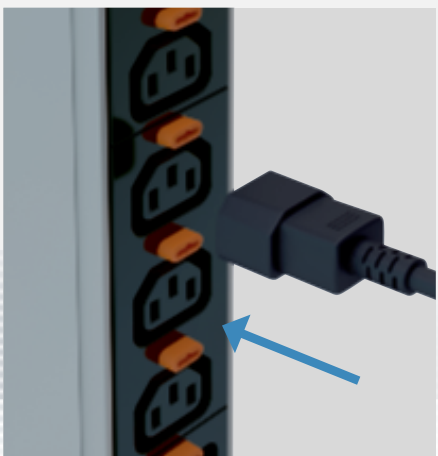

CORD CONNECTION
The cord is connected to the outlet naturally in one smooth action

2 AUTO LOCKING ✓

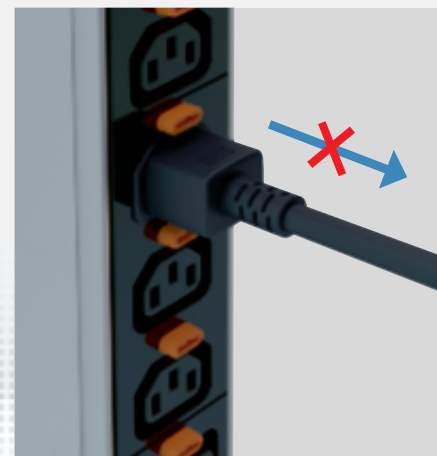

CORD HELD IN PLACE
Once the power supply cord is connected, it locks automatically and cannot be removed

3 UNLOCKING ✓

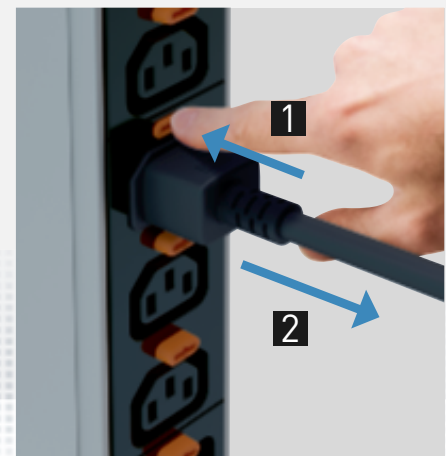

EASY REMOVAL
Simply pressing the unlock button releases the cord from the outlet

UNIVERSAL SYSTEM

Takes all cords for standard C13 and C19 outlets

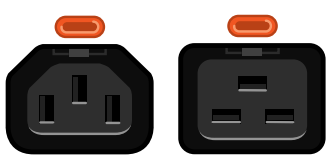

✓ **EXCLUSIVE TO LEGRAND**



ZERO-U PDUs

Innovation & performance

Exclusive innovations

Every detail matters! Legrand's unique and novel innovations, which include safety features, simplified setup and integration, and consumption indicators, help ensure optimum performance for the Zero-U range of PDUs.

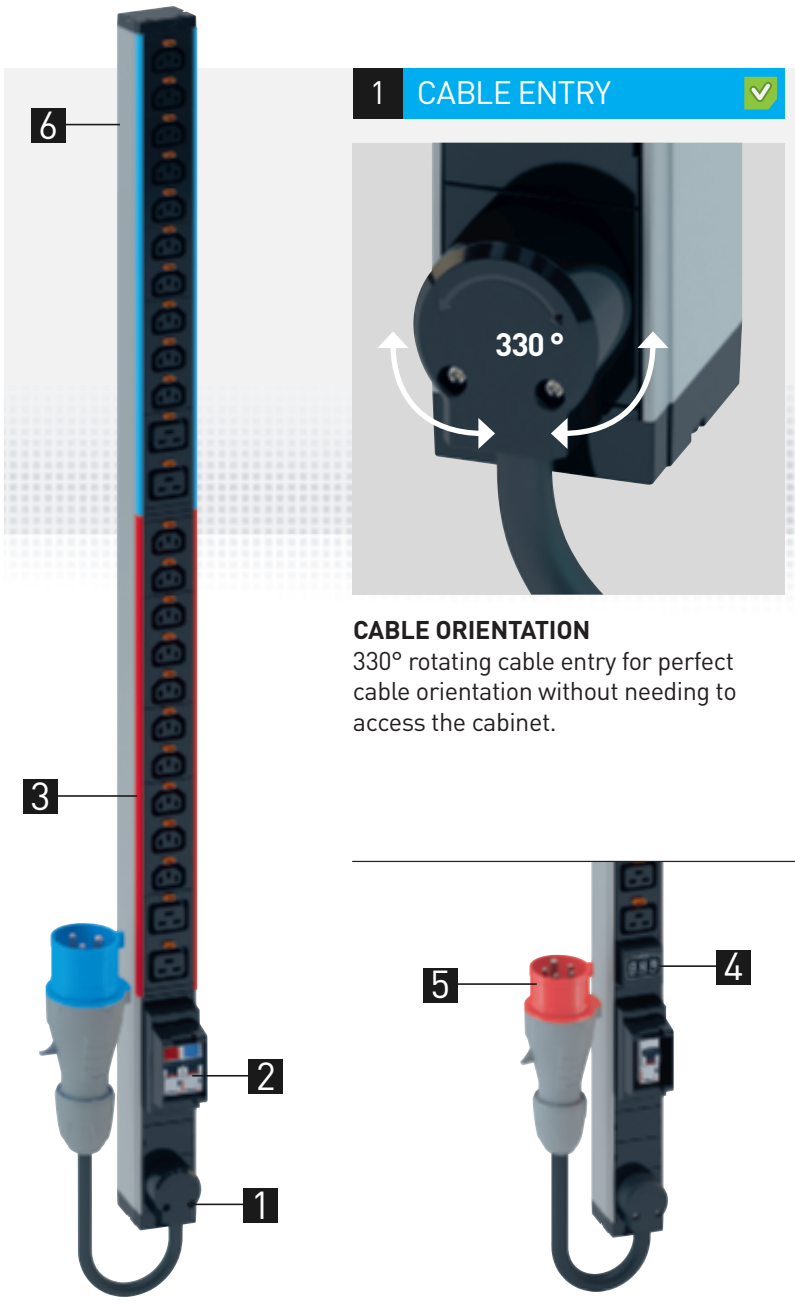

VERTICAL
INSTALLATION



2 MCB HOLDER

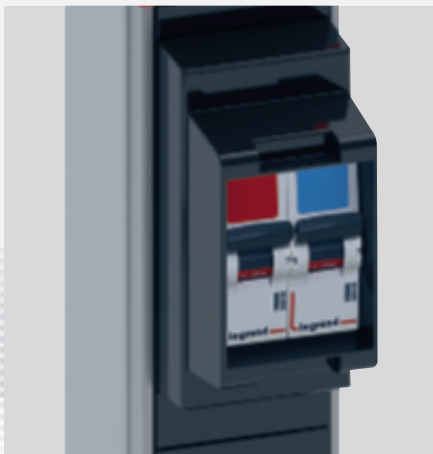

ENHANCED PROTECTION

Circuits protected by MCB. Holder with projecting edges to avoid unintended operation (a cover can be added on request).

3 IDENTIFICATION

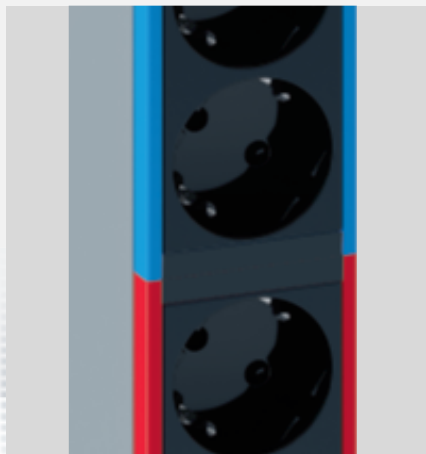

COLOUR-CODED CIRCUITS

Each circuit is colour-coded, with the colour clearly visible on the front panel and along the edges of a module.

The colour corresponds to the specific MCB protecting the circuit.

4 AMMETER



CONSUMPTION INDICATOR

Consumption is measured to ensure better installation management:

- Balancing circuits
- Display of available capacity
- Power features and overload prevention

5 POWER SUPPLY

There are multiple solutions depending on power supply requirements

16/32 A single-phase



16/32 A three-phase



6 SCREWLESS MOUNTING

Zero-U PDUs simply clip vertically into slots on the mounting frame without the need for any screws.

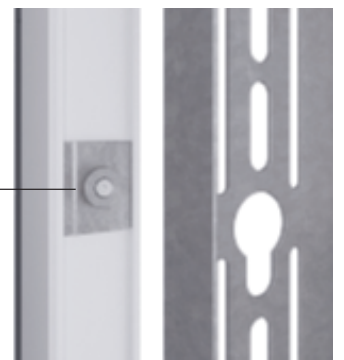
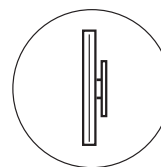

EXCLUSIVE TO LEGRAND



1U PDUs

Innovation & Convenience

Simple setup
and integration

The 19" PDUs designed for installation in server and cabling cabinets also incorporate the latest innovations for facilitating integration and maintenance, with clever mounting and operating features.

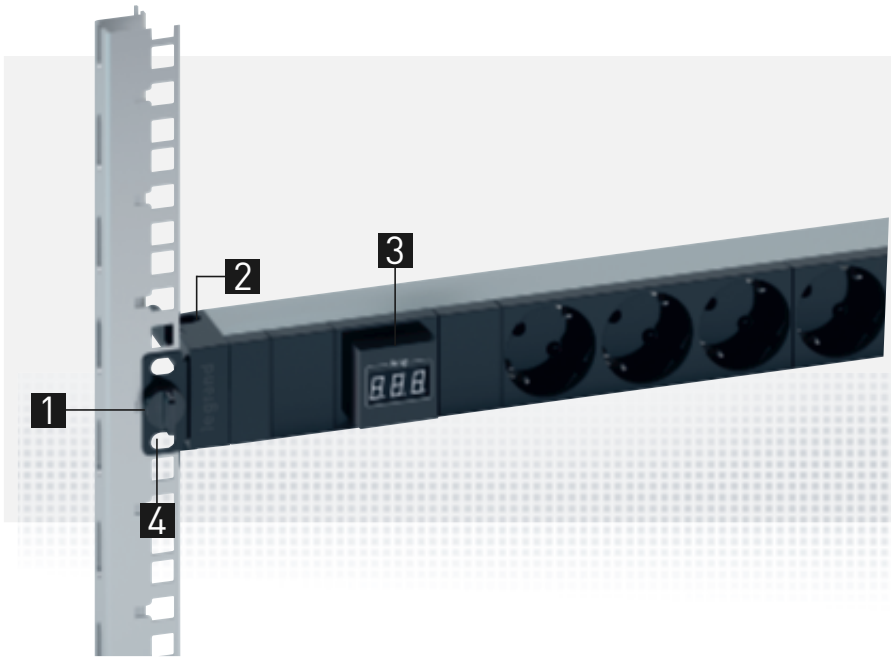
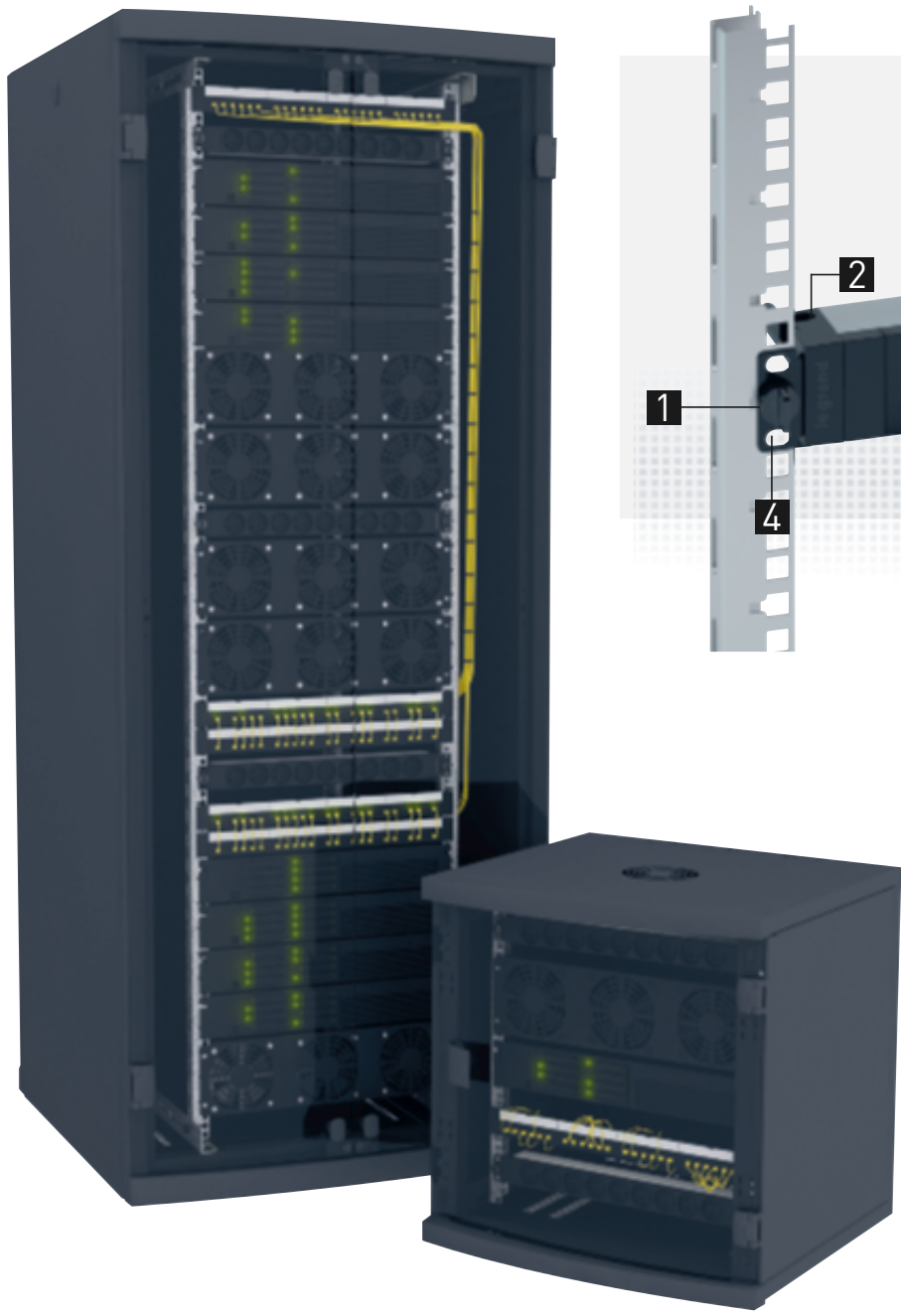

10" 1U PDUs

Specially designed for local area networks, these PDUs feature the same innovations as the 19" range.

HORIZONTAL INSTALLATION 



HORIZONTAL
OR VERTICAL
INSTALLATION



1 QUICK FIXING

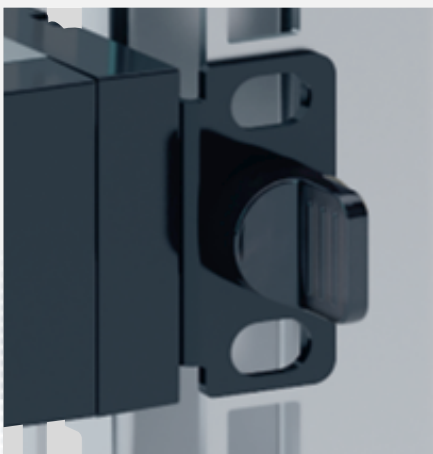

TOOLLESS INSTALLATION

Quick, toolless fixing on the 19" uprights. No screws or nuts required.

2 CABLE GUIDE



OPTIMISED SPACE

Cables are held firmly in place by a cable guide.

3 AMMETER

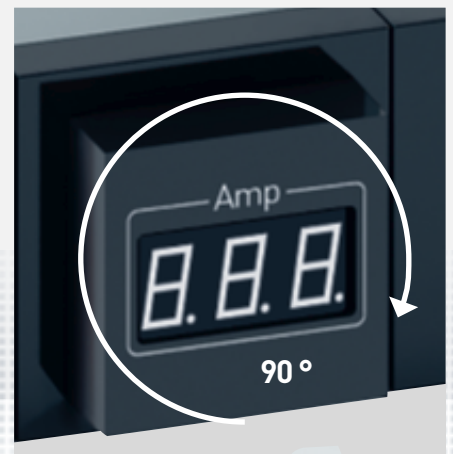

CHANGE OF POSITION

The ammeter can be rotated 90° to ensure easy reading regardless of mounting position (horizontal or vertical).

4 MOUNTING SUPPORTS

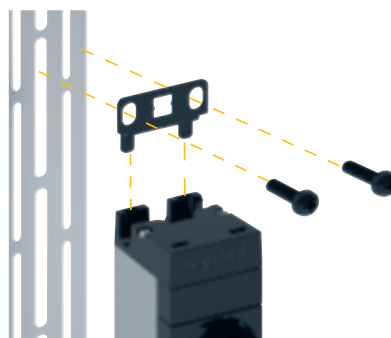
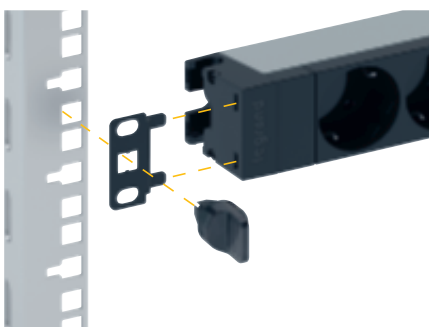

HORIZONTAL OR VERTICAL

Designed for horizontal toolless mounting, 1U PDUs can also be mounted vertically simply by rotating the mounting brackets. Vertical mounting requires a bolt and nut to fix the PDU firmly to the upright.

EXCLUSIVE TO LEGRAND



Protection accessories

Enhanced safety and control

Compatible with all the PDUs in the range, the complementary accessories allow you to control the power supply at the outlets and protect against overvoltages.

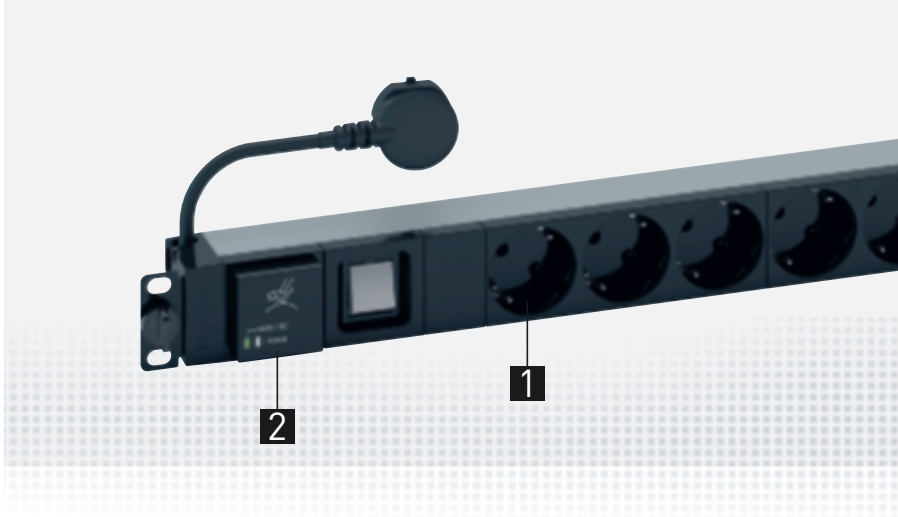

1 OUTLET LOCKING CAP ✓

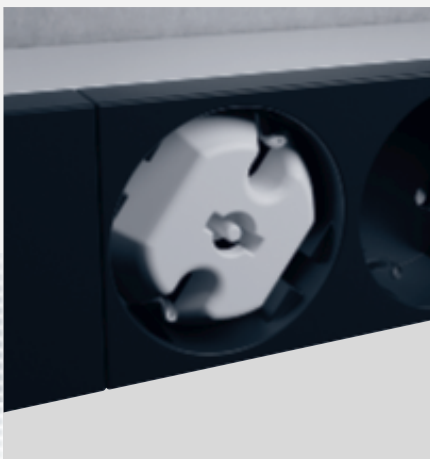

CONTROLLING ACCESS TO THE POWER SUPPLY

Locking caps are used to lock access to a socket. A special key is required to unlock it.

Locking caps available for the following standard socket outlets: C13, C19, German, French-Belgian, British



2 SURGE PROTECTION DEVICE



UNINTERRUPTIBLE PROTECTION

The surge protection module protects equipment against overvoltages and incorporates hot swap technology. It can be used to replace a used module without interrupting the power supply to the other equipment connected to the PDU.

This is an essential accessory for business servers which need continuous protection. The module is equipped with a warning LED which indicates when it needs replacing.

✓ EXCLUSIVE TO LEGRAND

Support you can rely on

It takes more than just sophisticated technological solutions to manage international projects successfully. What is really needed is the comprehensive and expert support of an experienced partner: from project design and choice of the right solution through to on-site logistics, installation and configuration, including any subsequent troubleshooting and maintenance.

Legrand is ideally placed to offer this type of support, as all its products and solutions are developed and produced in close proximity to its customers. It also offers a wide range of special services and support tools which create genuine added value by making customers' day-to-day business significantly easier. This support is available at every stage of the project, whatever the customer touchpoint.





01 A diverse range of digital tools including websites, social media and news feeds so you can contact Legrand at any time and stay up to date with all essential news that is relevant to your projects.



02 Personal advice, technical support and documents, white papers, catalogues and e-catalogues, mobile apps, and software to help with product choice or drawing up bills of materials.

03 Training courses covering actual product expertise as well as the latest developments in technology, standards and regulations. Customised training courses available on request, either face to face or in virtual online classes.

04 Configurators, project software and AutoCAD libraries for project design, open for integration into existing software solutions wherever possible.

Evolution of standard 11801 Edition 3 - 2018

Introduction

Within customer premises, the importance of the cabling infrastructure is similar to that of other fundamental building utilities such as heating, lighting and mains power. As with other utilities, interruptions to service can have a serious impact. Poor quality of service due to lack of design foresight, use of inappropriate components, incorrect installation, poor administration or inadequate support can threaten an organisation's effectiveness.

Historically, the cabling within premises comprised both application-specific and multipurpose networks. The original edition of this standard enabled a controlled migration to generic cabling and the reduction in the use of application-specific cabling. The subsequent growth of generic cabling designed in accordance with ISO/IEC 11801 has:

- a) contributed to the economy and growth of Information and Communications Technology (ICT)
 - b) supported the development of high data rate applications based upon a defined cabling model, and
 - c) initiated development of cabling with a performance surpassing the performance classes specified in ISO/IEC 11801:1995 and subsequent editions:
- ISO/IEC 11801:1995 (Ed. 1) - first edition
 - ISO/IEC 11801:2000 (Ed. 1.1) - Edition 1, Amendment 1
 - ISO/IEC 11801:2002 (Ed. 2) - second edition
 - ISO/IEC 11801:2008 (Ed. 2.1) - Edition 2, Amendment 1
 - ISO/IEC 11801:2010 (Ed. 2.2) - Edition 2, Amendment 2

The 3rd Edition of ISO/IEC 11801 is now a multipart standard with the structure shown below. It is at the Final Draft International Standard (FDIS) stage in 2017, and is due to be published in early 2018:

ISO/IEC 11801 3rd Edition
General requirements (11801-1)
Specific requirements for premises:
- Offices & commercial buildings (11801-2)
- Industrial premises (11801-3)
- Homes (11801-4)
- Data centers (11801-5)
- Distributed building services (11801-6)

The International Standard ISO/IEC 11801-1 will specify requirements for balanced twisted-pair copper (Classes A, B, C, D, E, EA, F, FA, I and II), and fibre optic (OM1, OM2, OM3, OM4, OM5, OS1a, and OS2) cabling systems used in offices (ISO/IEC 11801-2), industrial buildings (ISO/IEC 11801-3), homes (ISO/IEC 11801-4), data centers (ISO/IEC 11801-5), and for the distribution of services in buildings (ISO/IEC 11801-6). This standard series will specify the structure and minimum configurations of generic cabling, performance requirements of channels, links, connecting hardware and cords, implementation requirements, compliance requirements and verification procedures, and interfaces. Requirements for cable performance are made via reference to applicable IEC standards.

Dealing with balanced twisted-pair cabling, new Classes I and II are specified with Category 8.1 (RJ45 connectors) and Category 8.2 (proprietary connector) components respectively.

Balanced Twisted-Pair Class Specifications of ISO/IEC 11801-1:

- Class A is specified up to 100 kHz
- Class B is specified up to 1 MHz
- Class C is specified up to 16 MHz
- Class D is specified up to 100 MHz
- Class E is specified up to 250 MHz
- Class EA is specified up to 500 MHz
- Class F is specified up to 600 MHz
- Class FA is specified up to 1000 MHz
- Class I and Class II are specified up to 2000 MHz

Significant changes from the previous edition include: Class I and II channel and link requirements have been added

- Category 8.1 and 8.2 connecting hardware and cord requirements have been added
- Cabled OM1, OM2, and OS1 optical fibre is no longer recommended for new installations
- Cabled wideband OM4 (OM5) and OS1a optical fibre requirements have been added

This International Standard provides:

- a) users with an application-independent generic cabling system capable of supporting a wide range of applications
- b) users with a flexible cabling scheme making modifications both easy and economical
- c) building professionals (for example, architects) with guidance allowing the accommodation of cabling before specific requirements are known; that is, in the initial planning for either new construction or refurbishment
- d) industry and application standardisation bodies with a cabling system which supports current products and provides a basis for future product development.

This International Standard specifies a multi-vendor cabling system which can be implemented with material from single and multiple sources, and is related to:

- a) international standards for cabling components developed by committees of the IEC, for example copper cables and connectors as well as fibre optic cables and connectors (see Clause 2 and bibliography)
- b) standards for the installation and operation of information technology cabling as well as for the testing of installed cabling (see Clause 2 and bibliography)
- c) applications developed by technical committees of the IEC, by subcommittees of ISO/IEC JTC 1 and by study groups of IEEE 802 and ITU-T, for example for LANs and ISDN
- d) planning and installation guides which take into account the needs of specific applications for the configuration and the use of cabling systems on customer premises (for example ISO/IEC 14709 series, ISO/IEC 14763 series, ISO/IEC 30129, and ISO/IEC 18598).

Physical layer requirements for the applications listed in Annex E have been analysed to determine their compatibility with the cabling classes specified in this standard. These application requirements, together with statistics concerning the topology of premises and the model described in ISO/IEC 11801-2 clause 8.2, have been used to develop the requirements for Classes A to FA and fibre optic cabling systems.

In offices horizontal balanced cabling should now be designed to provide minimum Class E, and minimum Class EA is recommended to support applications with data rates exceeding 1 Gigabit/sec.

Scopes

Scope of ISO/IEC 11801-1: Generic cabling for customer premises – Part.1 General requirements

This International Standard specifies requirements that are common to the other parts of the ISO/IEC 11801 series. Cabling specified by this standard supports a wide range of services including voice, data, and video that may also incorporate the supply of power.

This International Standard specifies:

- a) The fundamental structure and configuration of generic cabling requirements within the type 400 premises defined by the other standards in the ISO/IEC 11801 series
- b) channel transmission and environmental performance requirements
- c) link performance requirements
- d) component performance requirements, referring to available International Standards for 404 components and test methods where appropriate
- e) test procedures to verify compliance with the cabling transmission performance requirements 406 of the 11801 series documents.

Note: This International Standard does not contain specific compliance requirements. The cabling design documents supported by ISO/IEC 11801-1 incorporate the requirements of this standard as part of their individual compliance requirements.

In addition, ISO/IEC 11801-1 provides information regarding the applications supported by the cabling channels. ISO/IEC 11801-1 has taken into account requirements specified in the application standards listed in Annex E.

Scope of ISO/IEC 11801-2 – Generic cabling for customer premises – Part.2 Office premises

This International Standard specifies generic cabling for use within office premises, which may comprise single or multiple buildings on a campus. It covers balanced cabling and fibre optic cabling.

ISO/IEC 11801-2 is optimised for premises where the maximum distance over which telecommunications services can be distributed is 2000 m. The principles of this International Standard may be applied to larger installations.

Cabling specified by this standard supports a wide range of services including voice, data, and video that may also

incorporate the supply of power.

This International Standard specifies directly or via reference to ISO/IEC 11801-1:

- a) the structure and minimum configuration for generic cabling within office premises
- b) the interfaces at the telecommunications outlet (TO)
- c) the performance requirements for cabling links and channels
- d) the implementation requirements and options
- e) the performance requirements for cabling components
- f) the compliance requirements and verification procedures.

ISO/IEC 11801-2 has taken account of the requirements specified in application standards listed in ISO/IEC 11801-1:201X, Annex E.

Safety (e.g. electrical safety and protection and fire) and Electromagnetic Compatibility (EMC) requirements are outside the scope of this International Standard, and are covered by other standards and by regulations. However, information given by this standard may be of assistance.

Scope of ISO/IEC 11801-6 – Generic cabling for customer premises – Part. 6 Distributed building services.

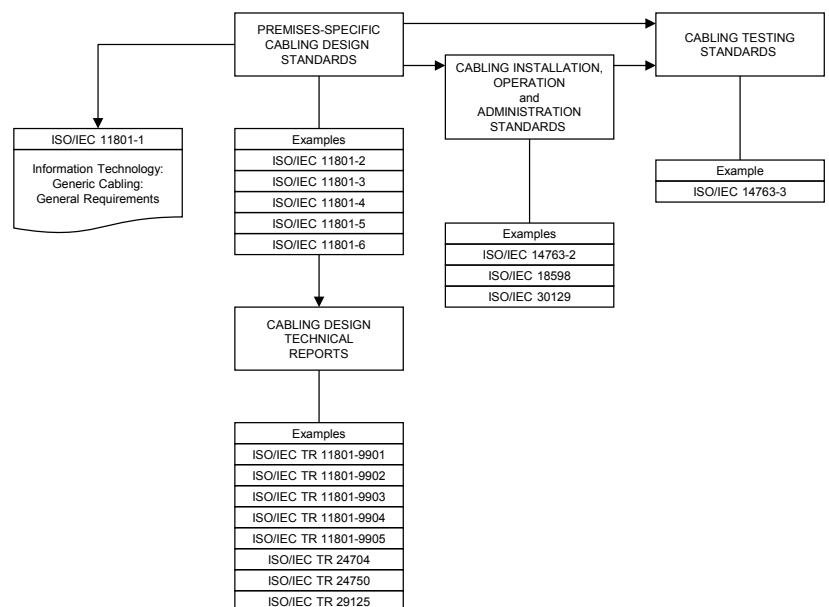

The information in this Figure is not automatically updated following the introduction, or removal, of international standards or Technical Reports

Source: ISO/IEC 11801-1 (2017)

The figure shows the schematic and contextual relationships between the standards relating to information technology cabling produced by ISO/IEC JTC 1/SC 25, namely the ISO/IEC 11801 series of standards for generic cabling design, standards for the installation, operation and administration of generic cabling and for testing of installed generic cabling.

The life expectancy of generic cabling systems can vary depending on environmental conditions, supporting applications, ageing of materials used in cables, and other factors, such as access to pathways (campus pathways are more difficult to access than building pathways). With appropriate choice of components, generic cabling systems meeting the requirements of this International Standard are expected to have a life expectancy of at least ten years.

CPR – Construction Products Regulation

The aim of the CPR regulation is to guarantee the free circulation of products made in the European Union, adopting a harmonised technical language which can define the performance and essential features of all construction products.

Electrical cables are rarely the cause of a fire but when they are involved they may form a seriously hazardous component because of their large quantities and because they are found in all rooms of the building. With careful prevention and making state-of-the-art systems with safe and high-quality components in accordance with the CPR regulation, fire propagation, the lack of visibility in smoke-filled rooms and the diffusion of corrosive and toxic gases can be reduced or almost totally eliminated.

The CPR regulation (EU 305/2011) concerns all the products made to be permanently incorporated (installed/used) in buildings and other civil engineering works (e.g. homes, industrial and commercial buildings, offices, hospitals, schools, undergrounds, etc.). As part of the features considered important for the safety of constructions included in the CPR, the European Commission has decided to consider cables' Reaction to Fire and Resistance to Fire, recognising the importance of their behaviour and role in fire. The release of harmful substances is one of the performances considered important for cables, although at present no minimum levels of performance have been established because when used normally the cables do not release harmful substances.

All the cables installed permanently in constructions, to transport power or for telecommunications, of any voltage level and with copper or fibre optic conductors, must be classified on the basis of the classes of premises where they will be installed.

The cables are classified in 7 classes of Reaction to Fire: Aca, B1ca, B2ca, Cca, Dca, Eca and Fca identified by the subscript "ca" (cable) as a function of their decreasing performance. As well as this main classification, the European authorities have also regulated the use of the following additional parameters:

- **a** = acidity which defines the hazard of the fumes for people and the corrosiveness for things. Varies from a1 to a3
- **s** = opaqueness of the smoke. Varies from s1 to s3
- **d** = dropping of incandescent particles which could propagate fire. Varies from d0 to d2.





A more severe check (System 1+) is required for the classes from Aca to Cca. It lays down the initial check and continuous monitoring of the product and checks of the manufacturing control system, while for the classes from Dca to Eca the check only lays down the initial product check (System 3). Class F, however, is based on the manufacturer's self-declaration (System 4).

The table below contains the classification of cables according to the test requirements of the CPR Regulation and the correlation between the cable classification and the most representative installation rooms.

	Euroclass	Classification criteria	Additional criteria	AVCP system (Assessment and Verification of Consistency of Performance)
Non combustible (e.g. mineral insulated)	A_{ca}	EN ISO 1716 Gross heat of combustion		<p>"1+", including:</p> <ul style="list-style-type: none"> initial type-testing and continuous surveillance
Low-Fire-Hazard cables (various levels)	B1_{ca}	EN 50399 Heat release Flame spread	Smoke production (s1a, s1b, s2, s3) EN50399/EN61034-2 Acidity (a1, a2, a3) EN 50267-2-3 Flaming droplets (d0, d1, d2) EN 50399	<ul style="list-style-type: none"> Audit & testing of samples by 3rd party certification body
	B2_{ca}			Factory production controls by manufacturer
	C_{ca}			
	D_{ca}			
Standard cables	E_{ca}	EN 60332-1-2 Flame propagation		<p>"3", including:</p> <ul style="list-style-type: none"> initial type-testing by 3rd-party laboratory
No performance determined	F_{ca}	EN 60332-1-2 Flame propagation		<p>"4"</p> <p>initial type-testing and factory production controls by manufacturer</p>



FOLLOW US
ALSO ON

- @ legrand.com
-  youtube.com/user/legrand
-  facebook.com/Legrand
-  twitter.com/Legrand
-  pinterest.com/legrandgroup
-  instagram.com/legrandnews



Headquarters

128, avenue de Lattre de Tassigny
87045 Limoges Cedex
France
Tel.: + 33 (0) 5 55 06 87 87
Fax: + 33 (0) 5 55 06 88 88