



INTEGRATED SOLUTIONS

FOR THE FOOD & BEVERAGE
INDUSTRY

GLOBAL SPECIALIST IN ELECTRICAL AND
DIGITAL BUILDING INFRASTRUCTURES

 legrand®



LEGRAND AT THE HEART OF THE FOOD AND BEVERAGE INDUSTRY

Energy and food safety issues are at the heart of manufacturers' concerns. Electrical energy makes up 30% of the energy used at a food processing site and manufacturers need to reduce their environmental footprint while making continuous productivity gains. Legrand subscribes to this approach and it supports the stakeholders in the food processing industry with their plans and with their efforts to improve performance.



AN INTERNATIONALLY RECOGNISED GROUP

Legrand offers, throughout the world, a comprehensive range of systems for implementation of electrical installations and information networks suited to all types of projects. In total, Legrand offers 170,000 catalogue numbers and has a portfolio of more than 4,800 patents.

73 subsidiaries and offices,
and sales in approximately **180** countries

33,000 employees
worldwide

Sales of
€4.25 billion in 2011

LEGRAND AND SUSTAINABLE DEVELOPMENT

For many years, Legrand has been committed, together with its customers and partners, to a process of continuous improvement to ensure the profitable, long-term and responsible growth of its activities.

The Group thus intends to respond to the environmental, economic and social challenges of today and the future.

1. A GLOBAL APPROACH TO SUSTAINABLE DEVELOPMENT

Legrand's sustainable development policy covers three areas: social responsibility, the environment and governance.

Learn more at www.legrand.com

2. REDUCING THE IMPACT OF SITES

Since 1996, Legrand has included environmental management and protection in the operation of its industrial sites.

3. CONTROLLING THE USE OF CHEMICALS

In manufacturing its products the Legrand Group routinely tries to find technical solutions to replace hazardous substances.

4. ECO-DESIGNED PRODUCTS

Because products have a global impact on the environment throughout their life cycle, Legrand practises eco-design.

CORPORATE SOCIAL RESPONSIBILITY

Legrand is committed to a global policy of transparency, illustrated by voluntary actions such as signing the Global Compact or meeting the strict social and environmental criteria of the FTSE4Good and DJSI stock market indices*.

* Based on an assessment in 2011 subject to annual re-evaluation





Processing area



Technical room



Storage



Administration



Energy savings and control over operating costs

Being aware of environmental problems and of the issues experienced by operators, Legrand offers effective solutions for making energy savings and gaining control over operating costs: supply inverters, transformers, reactive energy compensation systems, etc.



Hygienic Design

Legrand offers solutions that are specially designed to meet hygiene standards and for easier application of HACCP directives. These solutions minimise health risks and guarantee an easy and rapid cleaning process. Time savings on a daily basis, compliance with health standards and reduction in outlays for specialist cleaning companies.





HYGIENE

AND PERFORMANCE

Energy savings,
control over operating
costs, hygiene,
strength, adaptability
and durability
of installations.

Faced with the hygiene and safety requirements in the food processing industry, Legrand provides its expertise to give relevant and long-term responses to the needs of operators.



Sturdiness and durability of installations

Additional tests are carried out in our laboratories on the products that are aimed at food processing environments. The type of stainless steel, their surface treatment as well as the plastic or composite materials used guarantee optimum resistance to oxidising and abrasive washing products. Their exceptional quality minimises their need to be replaced and guarantees long life cycles for installations.



Easy adaptability and reconfiguration for installations

Legrand solutions (electrical trunking, cable trays, etc.) allow easy reconfiguration of the different areas in buildings and permit easy and quick adaptability for electrical installations in the food processing industry. Guaranteed adaptability and simplified maintenance operations.



1 Safety and reduced maintenance

Legrand dry-type HV/LV transformers combine optimized electrical energy consumption with low environmental impact to offer a reliable, energy-efficient solution. They can reduce electricity consumption by up to 20% during off-peak activity phases in food and beverage industries.

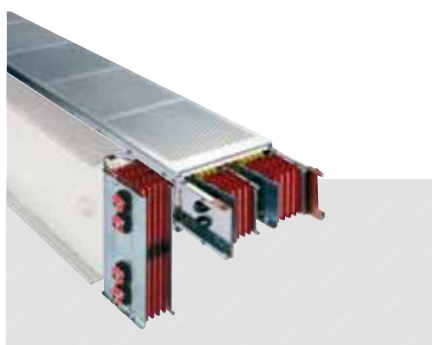

2 Solution for the distribution of high currents

Legrand's prefabricated busbar trunkings offer complete distribution systems for high currents of up to 6300 A. Busbar trunking is quick to install and offers great flexibility by enabling reconfigurations without any service interruption. Different available ranges for : power distribution, lighting or technical floor.



3 Efficient protection up to 6300 A

To guarantee efficient protection and effective service continuity, Legrand proposes DMX³ air circuit-breakers, DPX³ MCCBs, supply inverters, isolating switches and XL³ distribution enclosures as a set of fast-deployable solutions integrating cutting-edge technologies. XL³ power enclosures are type tested according to IEC 61439-2 and allow multiple configurations and all level of forms up to 4b.

RELIABILITY AND CONTINUITY OF SERVICE



Service continuity,
power distribution,
control over
consumption and
energy quality

The technical room is a strategic area in food industry establishments. It has to distribute and protect the entire electrical infrastructure of the building. It has also to take account of energy quality and lower energy consumption considerations. Legrand offers the right solutions to ensure 24 hour-a-day operation of the production units, manage operating costs and ensure the electrical safety of the installation...



4 Continuity of service

A good continuity of service is essential for industrial sites, requiring a high level of availability. Legrand offers a new "increased safety" distribution system guaranteeing the service level of the electrical switchboard during normal operation, maintenance or evolution of the installation.



5 Energy quality

Increase energy efficiency of your food industry building through solutions that either optimize energy quality and enable reduced energy consumption. Legrand's reactive energy compensation systems contribute to increasing all-round output of the electrical installation. Capacitor banks compensate for the reactive energy of your electrical installation, thereby enabling energy bill to be reduced.



6 Energy management: measurement and metering

By monitoring the consumption of your building, you can make savings of 8 to 12%. And by combining this with action plans, you can optimise performance and commit to a sustainable development process. Legrand proposes electricity meters, multi-function measuring units... and has developed an e-communication infrastructure for displaying energy consumption information.

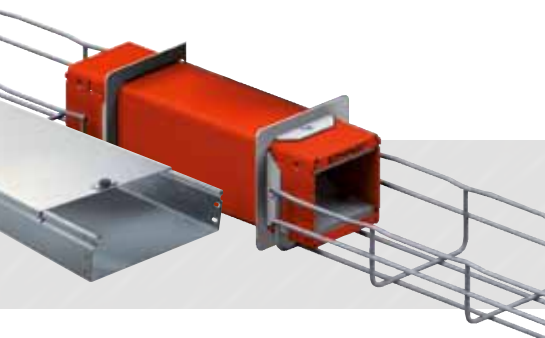

1 Cable routing with total safety

Legrand offers the widest range of cable trays on the market through the various leading brands in the group: trays, ladders, wire mesh, in steel, plastic or composite for low and high current applications. Solutions for routing cables with total safety both out of doors and indoors and for securing the installation using Ez Path™ fire systems.



2 Industrial enclosures

Altis stainless steel enclosures are designed in accordance with XPU 60-010 hygiene standards. They combine cleanability and sturdiness thanks to the quality of their stainless steel and surface roughness of $\leq 0.5 \mu\text{m}$. They offer a remarkable cabling capacity, numerous accessories and customised holes and finishes. Their IP 66 protection class in the monobloc version is suitable for hosing down in food processing areas.



3 Process equipment protection

DX3 modular circuit breakers and DPX3 MCCBs allow high breaking capacity at high nominal current. Ideal for protecting process equipment, they can be incorporated perfectly into Altis enclosures.

ENERGY DISTRIBUTION IN PROCESSING AREAS



Compliance with requirements related to hygiene, easier maintenance and flexibility of the installation

The productivity gains, standard requirements and as well as the short life cycles of food processing products give rise to frequent updates on production lines. The Legrand Group integrates these problems into its product ranges by offering reconfigurable solutions. They are easy to install, flexible, and guarantee service continuity.

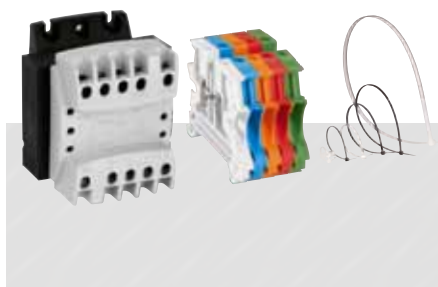

4 Power supplies, control and signalling units, cabling components

Legrand offers a comprehensive range of fittings for cabinets and enclosures in sensitive environments: cable trunking, Viking 3 terminal blocks, cable ties to guarantee safety with the connections in automation cabinets and ensure significant time saving during installation process.



5 Prefabricated lighting busbars

Dedicated to providing power for lighting applications, prefabricated lighting busbars are very easy to install. Compared with conventional cable systems they guarantee reduced installation time and also provide operators with maximum flexibility for area reconfigurations.



6 Weatherproof emergency lighting

Specially designed for the food processing industry and for damp areas, these weatherproof stainless steel units fitted with low consumption LEDs are IP 67 and are designed without a retention area and can also be controlled and tested remotely.

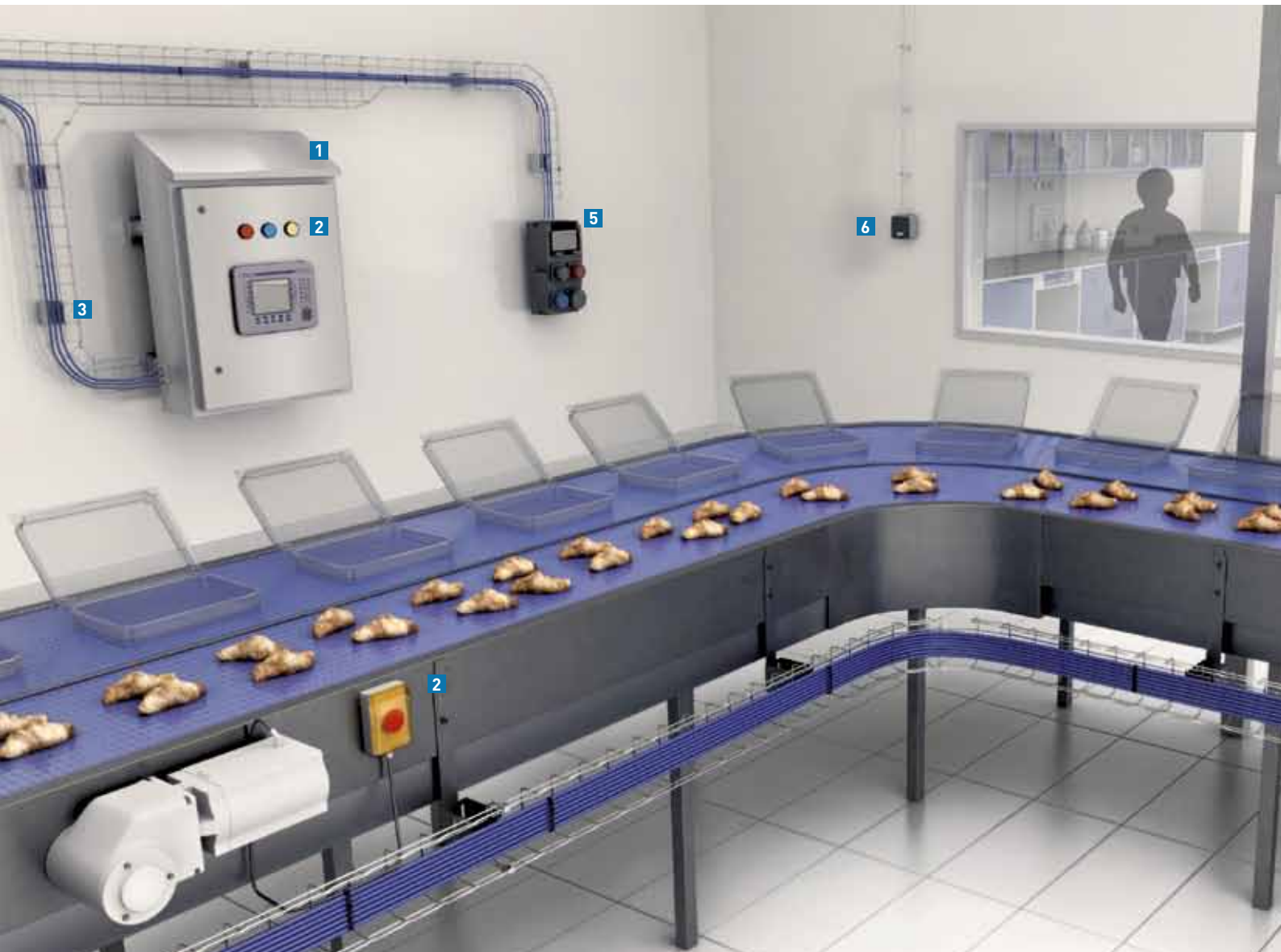

1 Hygienic Design enclosures

Atlantic stainless steel 304L or 316L is specially designed to be at the heart of the process in the food and beverage industry. Its IP 66 and IK10 impact resistance provide outstanding levels of resistance. Its sloping roof, rounded corners and lower surface roughness at $\leq 0.5 \mu\text{m}$ ensure its compatibility for the food processing industry. The cabinets can be fitted with a 4mm Securit glass window which prevents the need for excessive opening in sensitive areas.

2 Control and signaling units

A comprehensive range of rotary buttons, boxes and isolating switches up to IP 67 which are perfectly suited for stainless steel cabinets and enclosures, and for the machines and equipment found in food processing areas. They guarantee easy installation and a very high resistance over time in difficult areas.

3 Accessories for cable trays

The Cablofil™ wire mesh cable tray is suitable for flexible control and instrumentation applications, reducing installation time considerably along with the risks of cable damage thanks to its safety edge. Food industry supports and brackets for flag or ceiling mounting reduce dust retention areas and make cleaning easier. Available in stainless steel to complete the Legrand food industry product range.



SAFETY

IN FOOD PROCESSING AREAS

Final distribution to automation cabinets, industrial sockets and machines: safety, design and compatibility for the food industry, robustness and reliability of the cabling components.

Being aware of the essential need for safety in this area, Legrand implements specific test protocols for the solutions dedicated to the food processing industry: cleanability, resistance to cleaning products, robustness. These solutions meet the applicable standards as well as the requirements of the food processing sector.



4 Cable protection

RTA flexible or rigid conduits provide protection for cables for dynamic or static applications in the most extreme temperature and humidity conditions. Made of stainless steel, plastic or composite materials they are easily adaptable to the constraints of food processing environments. The conduit/cable-gland set guarantees IP 68, ideal for machines and lines cleaned on a daily basis.



5 Industrial sockets and cabinets

Legrand offers customised Hypra combined unit solutions for the specific needs of the food industry. They are suitable for high-humidity areas thanks to the triple IP design and guaranteed minimum IP 55. The materials used (plastic, metal, rubber) have been chosen to meet both electrical and mechanical safety requirements and to resist the various stresses in the food processing environment.



6 Plexo™ wiring accessories: unfailing protection

The Plexo Programme guarantees outstanding protection in all damp environments. Available with IP 55 and IP 66 with antimicrobial treatment, this range is ideal for meeting the hygiene requirements in the food processing industry, preventing the spread of bacteria and providing resistance to frequent cleaning processes.

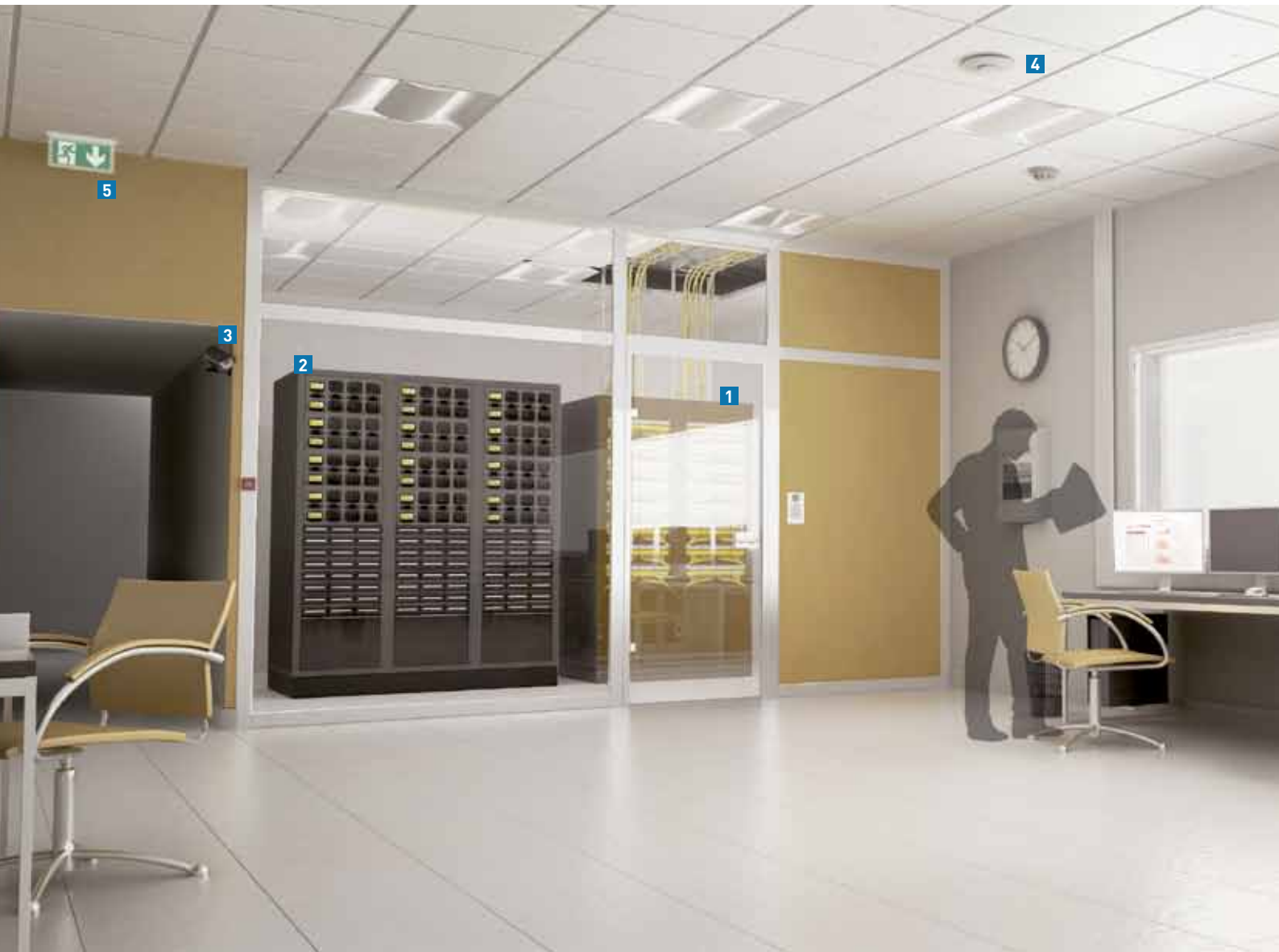

1 Performance and flexibility

The LCS² Legrand Cabling System offer includes copper, fibre optic and Wi-Fi solutions as well as VDI enclosures. It offers flexibility to the installation and a perfect synergy with other Legrand products such as cable management. Complete systems with a 20-year performance guarantee.

2 UPS enclosures (Uninterruptible Power Supply)

UPS enclosures guarantee service continuity. Their capacity of up to 120 kVA permits implementation of a secured network locally for machines, as well as for the site infrastructure in the event of a power cut.

3 Access Control and CCTV security

Protecting expertise contributes to success in the food processing industry. Access needs to be limited in certain critical areas such as laboratories. Legrand has developed a comprehensive range for securing the most sensitive areas.

CONTROL AND SUPERVISION



Data performance,
securing of
sensitive areas,
management and
control of electrical
energy consumption

The Legrand Group offers comprehensive solutions for buildings management as well as high-performance network solutions which ensure the safety of your site and staff, and ensure energy monitoring for your plant infrastructure.

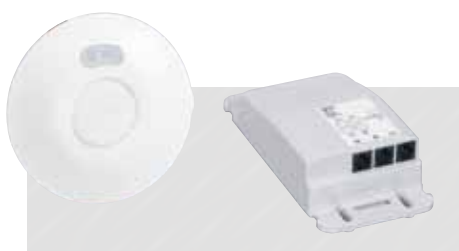

4 Stop the energy waste

Legrand's lighting management solutions provide a valuable contribution to green building initiatives such as BREEAM, LEED, HQE... From very simple installation with stand alone sensors to a global KNX solution with supervision, Legrand is able to control any lights in spaces to let you maximize energy saving and give comfort and flexibility.



5 Emergency Lighting and fire alarms

Legrand combines safety and energy savings, with its fire alarms and emergency lighting solutions equipped with low energy, long-life Leds. You obtain low energy consumption and reduce maintenance costs.



6 Maximising hygiene

A dedicated range of antimicrobial products: Mosaic™ Programme wiring accessories and antimicrobial snap-on trunking. All components are treated and designed with hygienic design shape and using Ag+ silver ions and have antimicrobial properties in accordance with the standard JIS Z2801.



Day-to-day support,
a specialist design office,
extended product warranties.



Showrooms and products
in real-life situations worldwide.



Training sessions and presentations
provided by professionals.



AT YOUR SERVICE ALL OVER THE WORLD

On all food processing building projects, Legrand is at your side, monitoring the project carefully from the initial idea through to construction, as well as during use.

At each stage of the design, Legrand benefits from a certified network of partners who bring their technological expertise to the table and provide essential backup to help the project progress.



A variety of communication materials - catalogues, technical brochures, website, etc.



Software for determining the size of installations and for implementing products.



Certified products - LOVAG - ACAE certification, IEC 61439-2 compliance.



FOLLOW US
ALSO ON

@ www.legrand.com

 www.youtube.com/legrand

 twitter.com/legrand

 **legrand**

Head office
and International Management
87045 Limoges Cedex - France
Tel: + 33 (0) 5 55 06 87 87
Fax: + 33 (0) 5 55 06 74 55