

DLP LED SYSTEM

Let yourself
be guided by
the light

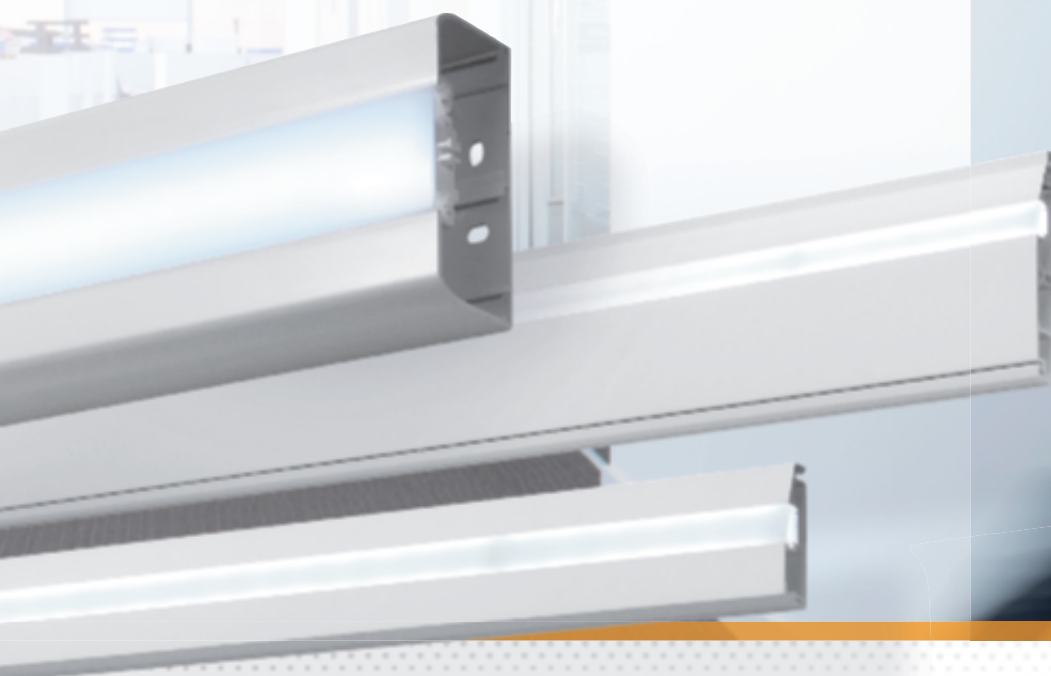

CATALOGUE
PAGES
INSIDE

THE GLOBAL SPECIALIST IN ELECTRICAL
AND DIGITAL BUILDING INFRASTRUCTURES

 **legrand**[®]

Follow the light
and move
around intuitively



Always in touch with trends in the market and new requirements in residential and commercial buildings, Legrand is offering a new range of illuminated mini-trunking, plinths, trunking and columns.

The new multifunction illuminated DLP range is used both to route high and low currents, bringing them as close as possible to users, and **to guide people by the light** in passageways. The low consumption LED lighting enables the energy consumption to be controlled and provides an ideal response to the energy efficiency issues in the

French RT 2012 regulations, which set the maximum primary energy consumption for new residential and commercial buildings (January 2013) at 50 kWh/m² per year.

With its neat design and a choice of several lighting colours, this new illuminated range is ideal both for **requirements in the passageways of non-residential buildings** (hotels, offices, museums, exhibition halls, hospitals) and **specific needs in the residential sector**, in particular for **the elderly who are losing their independence and/or are disabled** and want to continue to live safely in their own homes.

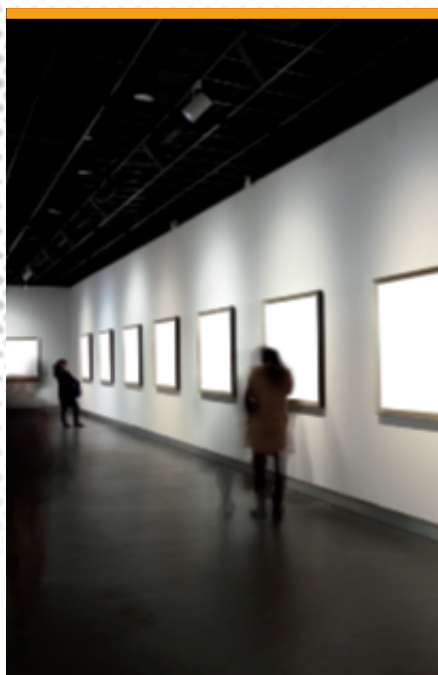

CONTENTS

Intuitive movement, visual comfort	2
Assistance and day-to-day comfort	4
A real light path with an attractive appearance	6
Energy savings and comfort for users	8
Catalogue pages	10



Intuitive movement, visual comfort

Legrand has enhanced its perimeter cable routing range (mini-trunking, plinths, trunking and columns) with the addition of the illumination function.

This function provides numerous possibilities for residential and commercial areas, helping people move around intuitively, guiding users in the dark and giving them real visual comfort.



Lighting module

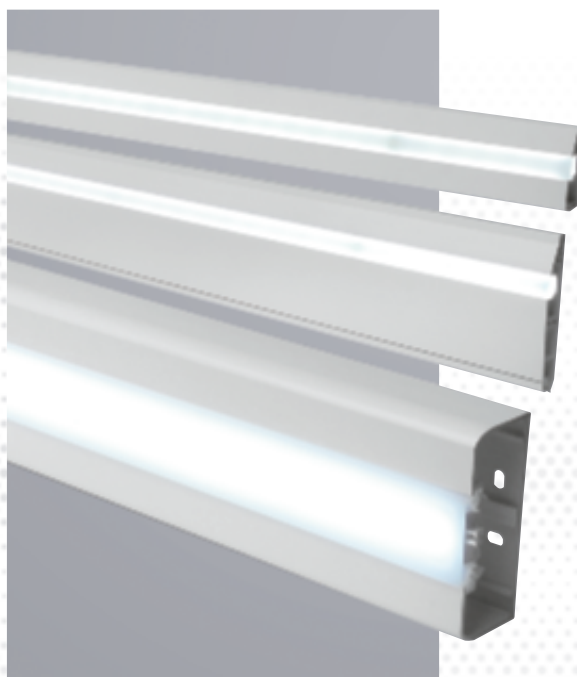

A varied range for residential and commercial premises

LED LIGHTING MODULE

The innovative feature of the range is the LED module, which is integrated into the covers. The LED System covers can be installed in place of the standard covers that are already fitted on mini-trunking, plinths, and snap-on trunking and columns of the same range.

Available as standard with white, blue or 2-colour red/green lighting (red/green only available on snap-on columns and trunking), it enables users to personalise their lighting environments according to their requirements and the area.

Other colours: on request.

3 lengths available: 0.5, 1 or 2 m.

A COMPLETE OFFER FOR THE RESIDENTIAL AND COMMERCIAL SECTORS

The DLP LED system is an attractive addition to the current range, limiting installation costs by combining the distribution of high and low currents and LED illumination in a single product. It takes all the functions that are essential for fitting out residential and commercial areas: 2P+E, RJ 45 and USB sockets, motion sensor, etc.

FLUSH-MOUNTING LIGHTING MODULE

This can be used for illumination (40 lm) or lighting (300 and 600 lm), depending on the power chosen. Designed for installation in dry partitions, its robust design, aluminium construction and low consumption, due to the use of LED technology, enable it to meet requirements for commercial buildings. Available with or without sensor with white, aluminium or black finish.

EASY TO INSTALL

The range combines simple surface-mounting installation and easy connection with the fast connectors (prewired) located at the ends of the LED modules. The system is supplied using ECG (ballasts) that are fully integrated in the range on dedicated supports for surface or flush-mounting or combined with the wiring accessories. There are several powers available (10, 35 and 60 W) depending on the length to be supplied (2, 6 or 10 m).

COMMON ACCESSORIES

The accessories for changes of direction (angles, junctions, etc.) are the same as those for the standard DLP range (without LEDs).

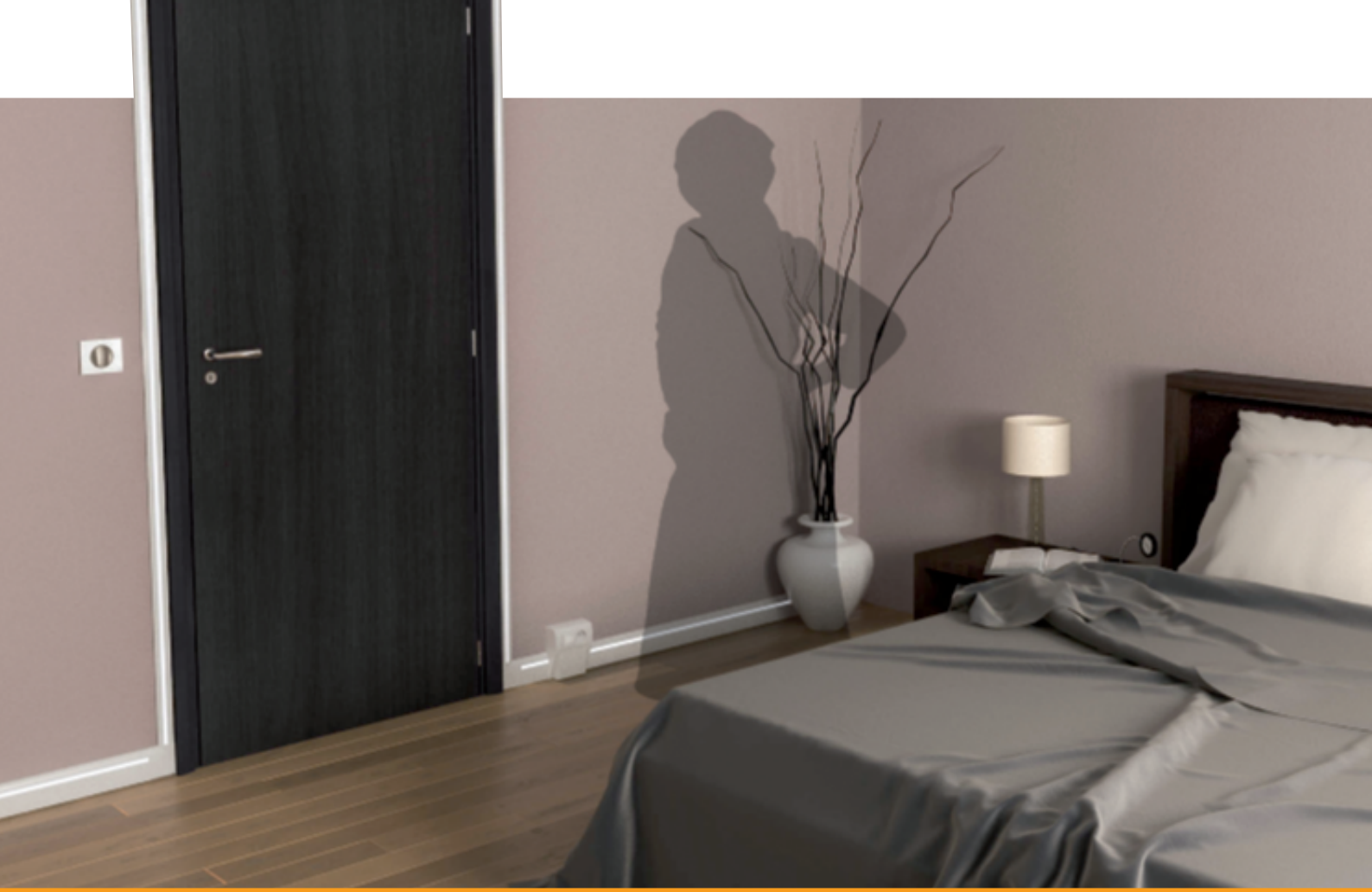

Assistance and day-to-day comfort

The new illuminated DLP range is a real step forward in terms of helping people who are losing their independence to continue living in their own homes. An illuminated pathway gives a threefold reduction in the number of falls (in residential homes for the elderly or private houses), and ensures real safety when moving around at night, providing day-to-day comfort for all those who want to continue living in their own homes.



Motion sensor



Door frame

85% of accidents are falls of people over 65, accounting for 9000 deaths a year

61% of accidents occur at home

40% of falls occur at night between the bedroom and the bathroom

8000 € Cost of hospitalisation for one fall

DES DÉPLACEMENTS NOCTURNES SÉCURISÉS

Le chemin lumineux permet des déplacements nocturnes sans allumer l'éclairage général. Associée au détecteur de mouvement, la plinthe allume automatiquement le balisage lorsqu'un mouvement est détecté.

La solution peut aussi faire office d'éclairage de circulation pour faciliter les interventions du personnel soignant en EHPAD ou dans un hôpital.

REASSURING VISUAL REFERENCE POINTS

An outline round a door, for example, provides vertical reference points enabling people to find their way around easily in the dark, to locate an exit or the door into another room, without having to switch on the general lighting.

EYE-FRIENDLY LIGHTING

The LEDs in the lighting module continuously diffuse a soft light, providing standby lighting < 5 lux. Their excellent quality ensures a high degree of visual comfort, with the sense of a continuous strip of light guiding people as they move around, without dazzling them.

LEGRAND: COMMITTED TO RESEARCH ON ASSISTANCE WITH INDEPENDENT LIVING

Working side by side with medical, social, economic and industrial organisations, Legrand has developed a strong commitment to the Silver Economy over recent years. It carries out research and development work on solutions and technologies to help elderly and/or disabled people who want to continue to live in their own homes for as long as possible.

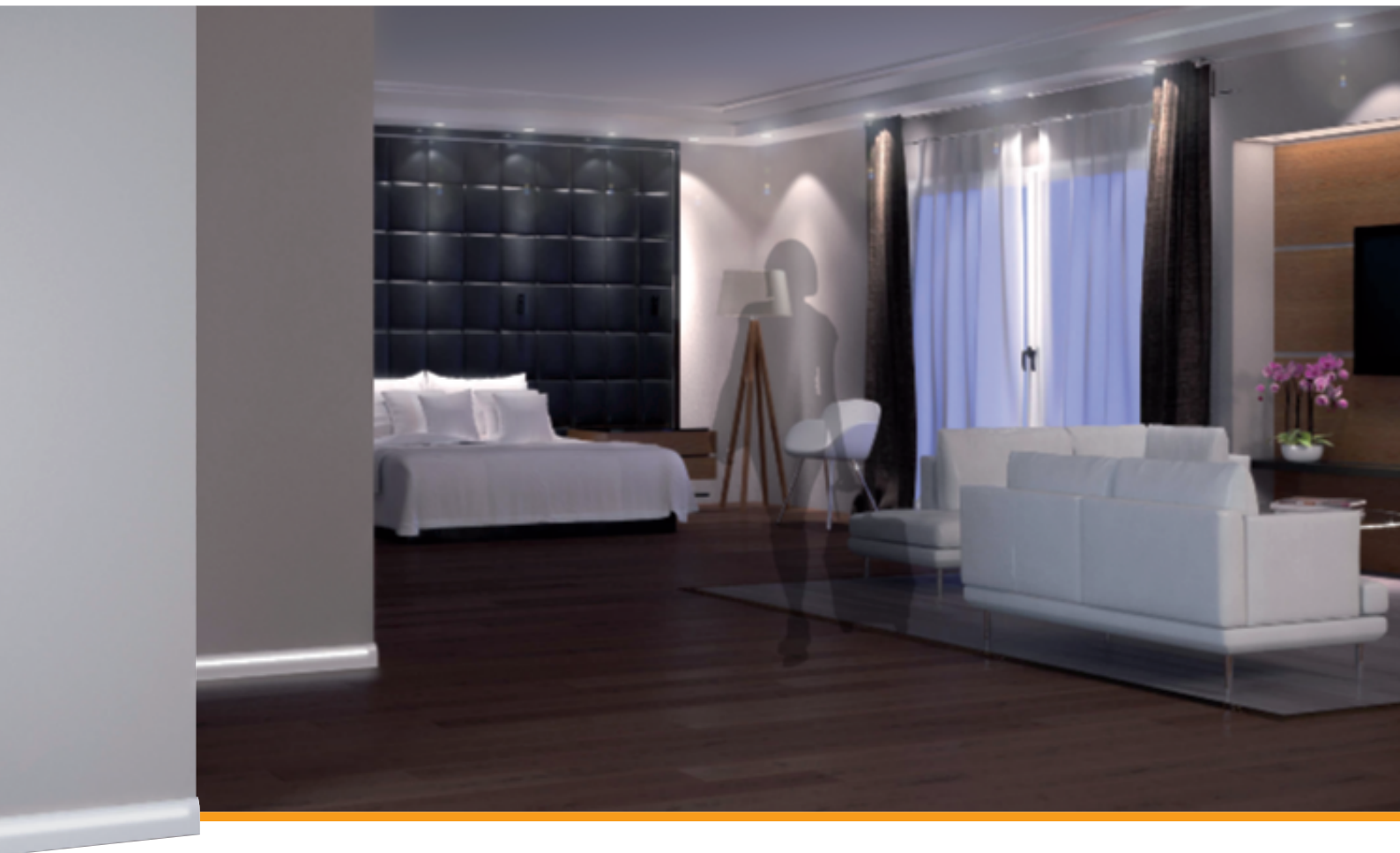

A real light path with an attractive appearance

Enhancing entrances, reception or exhibition areas with original lighting and designer solutions, guiding people intuitively by the light, etc., the illuminated DLP range provides numerous benefits for public areas: hotels, restaurants, shops, etc.



Trunking with white LED covers

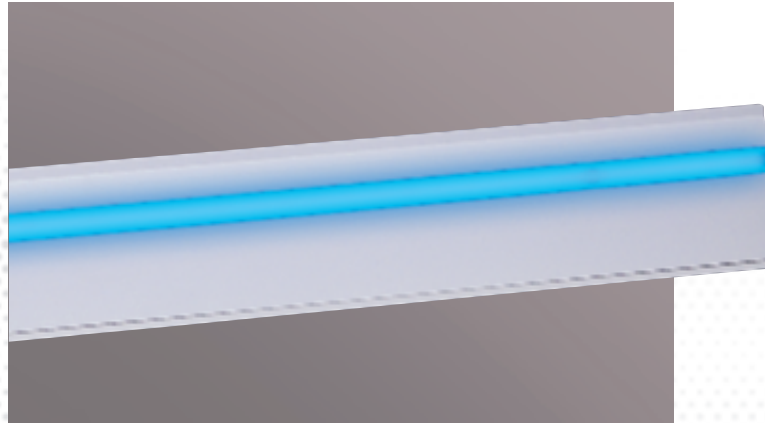

Plinths with blue LEDs

TRENDY, PERSONALISED LIGHTING ENVIRONMENTS

Beyond lighting, the system also gives an aesthetic value to the various spaces: a diffusing white light that will generate a subtle lighting on a point of sale for example, or an intense blue light to create a “trendy” atmosphere.

MOVE AROUND INTUITIVELY

With their integrated lighting, the trunking, plinths or mini-trunking can guide users intuitively in passageways for easier access to hotel rooms on different floors, etc.

AN ATTRACTIVE, DESIGNER TOUCH

The simple, modern design of the profiles brings elegance and discretion to residential and commercial areas.



Energy savings and comfort for users

The illuminated DLP range provides both comfort for users and energy savings for operators. The lighting modules, which are equipped with low consumption LEDs, reduce energy bills and comply with the requirements of the French RT 2012 regulations. **When used with motion sensors, the modules ensure perfect control of the electricity consumption by only providing the light required for users to move around. An ideal solution in shared areas: staircases, corridors, etc.**

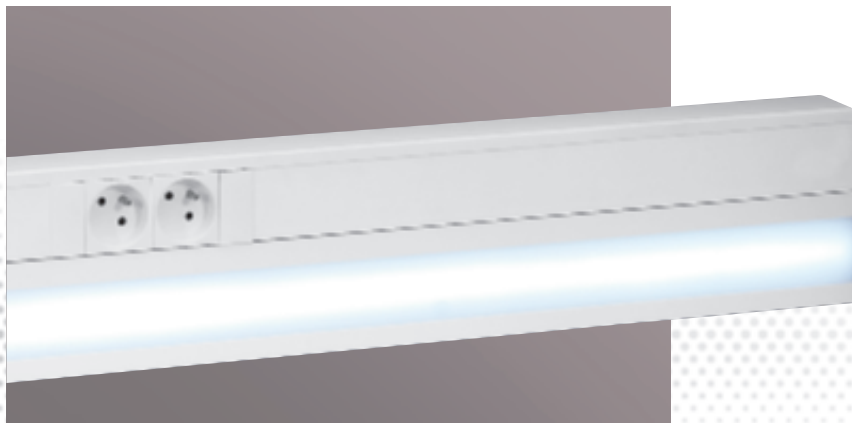

Trunking with LED cover



Flush-mounting module

GUARANTEED ENERGY EFFICIENCY

The very low consumption LEDs use very little energy and have a service life of more than 50,000 hours. Their high quality provides much appreciated visual comfort.

AN EFFECTIVE ADDITION TO THE GENERAL LIGHTING

Installed in snap-on trunking or columns, the white or blue LED lighting modules provide additional lighting at workstations for optimum user comfort. The LED modules can be used in numerous different configurations to ensure safety of movement in passageways (staff exits, night-time security rounds, etc.): horizontally in a corridor, vertically on a staircase, etc.

A SIGNALLING FUNCTION

Green/red two-colour modules, for installation in snap-on trunking or columns, can be used to indicate whether areas are vacant or engaged in commercial environments: offices, meeting rooms, cashiers' positions, etc.

FLUSH-MOUNTING LIGHTING MODULE

This can be used, for example, to indicate an obstacle (steps, a projection, etc.) or to accentuate a lighting environment. Is positioned above a plinth or high up.

LED system mini-trunking 40 x 12.5 profiles and finishing accessories

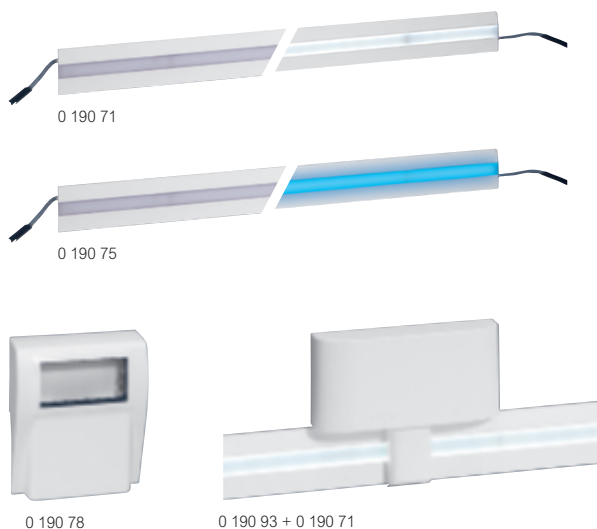

Pack	Cat.Nos	Mini-trunking
		Mini-trunking modules equipped with LED lights covers for contemporary mood lighting To be equipped with drivers Cat.No 0 190 90/91/92 (see opposite) according to required power Can take Mosaic or Arteor wiring accessories via support frame Cat.No 0 190 78
		White colour LED modules
2	0 190 70	Length 0.5 m
2	0 190 71	Length 1 m
2	0 190 72	Length 2 m
1	0 190 73	Door frame kit
		Blue colour LED modules
2	0 190 74	Length 0.5 m
2	0 190 75	Length 1 m
2	0 190 76	Length 2 m
1	0 190 77	Door frame kit
		Mini-trunking without LED
72 ¹	0 190 03	Length 2.1 m Supplied with cover With separation partition
		Finishing accessories
10	0 190 36	End cap
10	0 190 16	Changeable internal angle
10	0 190 12	Changeable external angle
10	0 190 24	Flat angle B
10	0 190 20	Flat angle A
10	0 190 40	Cover joint
		Mosaic / Arteor support frame
1	0 190 78	For LED system mini-trunking and plinth 4 modules (for horizontal mounting only) To be used with 2-module Mosaic or Arteor sockets



1: Number of meters in pack

LED system plinth 82 x 12.5 profiles and finishing accessories

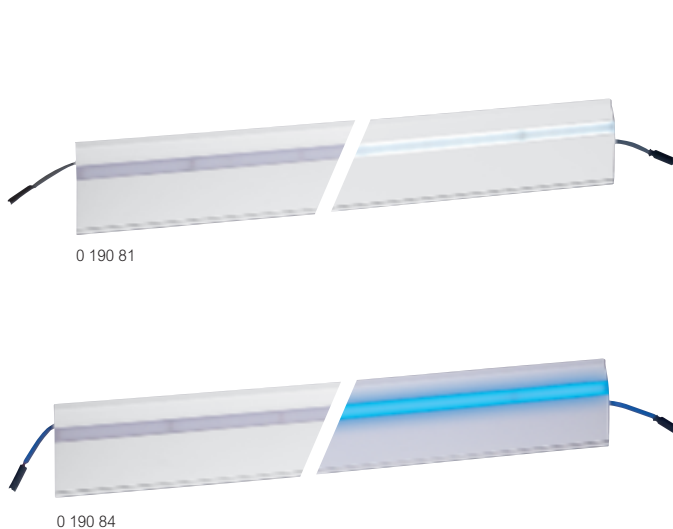

Pack	Cat.Nos	Plinth
		Plinth modules equipped with LED lights covers for contemporary mood lighting To be equipped with drivers Cat.No 0 190 90/91/92 (see opposite) according to required power Can take Mosaic or Arteor wiring accessories via support frame Cat.No 0 190 78
		White colour LED modules
1	0 190 80	Length 0.5 m
1	0 190 81	Length 1 m
1	0 190 82	Length 2 m
		Blue colour LED modules
1	0 190 83	Length 0.5 m
1	0 190 84	Length 1 m
1	0 190 85	Length 2 m
		Plinth without LED
30 ¹	0 190 06	Length 2.1 m Supplied with cover With separation partition
		Finishing accessories
10	0 190 49	End cap
5	0 190 45	Changeable internal angle
5	0 190 43	Changeable external angle
10	0 190 53	Right-hand flat junction
10	0 190 54	Left-hand flat junction
10	0 190 51	Cover joint
5	0 190 47	Junction to 30 x 12.5 mm and 40 x 12.5 mm mini-trunking
		Fixing accessories for drivers
		For fixing drivers alongside LED system mini-trunkings and plinths
		Surface mounting
		Supplied with two adaptors (for 40 x 12.5 mm respectively 80 x 12.5 mm profiles)
1	0 190 93	For 10 W driver Cat.No 0 190 90
1	0 190 94	For 35 and 60 W drivers Cat.No 0 190 91/92

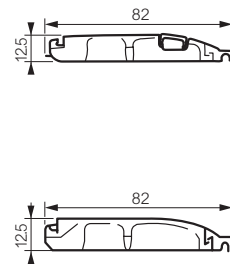

1: Number of meters in pack

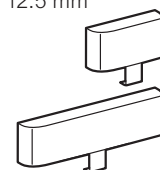

For the flush-mounting installation of the drivers use Batibox flush-mounting boxes and the covers Cat.No 0 801 82 and 0 190 96 **see p. 12**

LED system covers for snap-on DLP trunking and columns

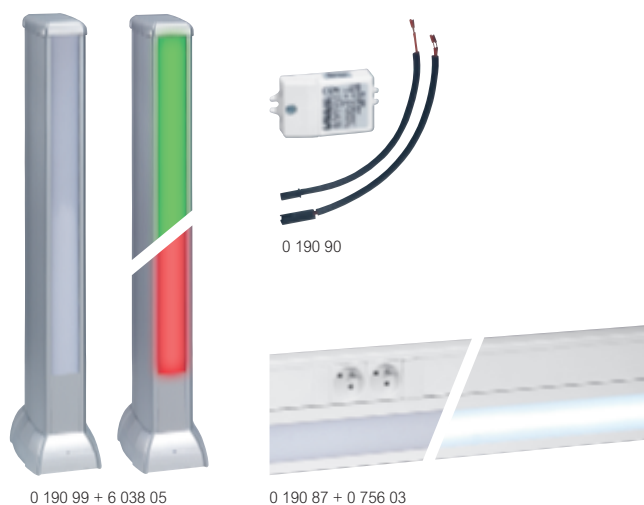

LED system flush-mounting lighting modules



Pack	Cat.Nos	LED system covers for snap-on DLP trunking and columns
		45 mm width covers with LED lights, to be installed on snap-on DLP trunking and columns instead of the standard cover supplied with the body To be equipped with drivers Cat.No 0 190 90/91/92 according to required power
1	0 190 86	White colour LED modules Length 0.5 m
1	0 190 87	Length 1 m
1	0 190 88	Length 2 m
1	0 190 99	Red / green colour LED module Length 0.5 m
10	6 380 00	Cover joint Width 45 mm
		Drivers for LED system mini-trunkings, plinths & covers
1	0 190 90	10 W - for a maximum length of 2 m
1	0 190 91	35 W - for a maximum length of 6 m
1	0 190 92	60 W - for a maximum length of 10 m
		Links
1	0 190 97	Length 0.3 m
1	0 190 98	Length 3 m

Pack	Cat.Nos	Flush-mounting LED lighting modules
		IP 44 - IK 07 (IP 40 for the automatic switch version) Aluminium-polycarbonate
		1.2 W - 40 lm - for way guidance Total consumption: 1.4 W Color temperature: 3000 K 262 x 87 mm
1	6 607 80	White finish
1	6 607 81	Aluminium finish
1	6 607 82	Black finish
		4 W - 300 lm Total consumption: - standard version: 4.2 W - automatic switch version: 4.4 W Color temperature: 4000 K 355 x 87 mm
1	6 607 83	White finish
1	6 607 84	Aluminium finish
1	6 607 85	Black finish
1	6 607 86	White finish with automatic switch (IR detection)
1	6 607 87	Aluminium finish with automatic switch (IR detection)
		7 W - 600 lm Total consumption: - standard version: 7.2 W - automatic switch version: 7.4 W Color temperature: 4000 K 355 x 87 mm
1	6 607 88	White finish
1	6 607 89	Aluminium finish
1	6 607 90	Black finish
1	6 607 91	White finish with automatic switch (IR detection)
1	6 607 92	Aluminium finish with automatic switch (IR detection)

DLP LED system

mini-trunking, plinth, LED covers and drivers

Wiring capacity

Mini-trunking

Cat.Nos 0 190 70/71/72/74/
75/76

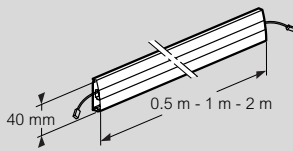

Plinth

Cat.Nos 0 190 80/81/82/83/84/85

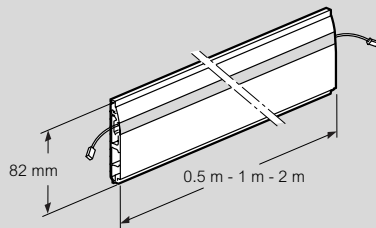

Compartment	Profile size	Cross section (mm ²)	Maximum wiring capacity (number of conductors)					
			1.5 mm ²	2.5 mm ²	4 mm ²	6 mm ²	UTP/FTP cat.6	Φ max
1	40 x 12.5	180	10 / 7 ⁽¹⁾	7 / 4 ⁽¹⁾	5 / 3 ⁽¹⁾	4 / 2 ⁽¹⁾	2	9.5 / 6 ⁽¹⁾
1	135	135	10 / 7 ⁽¹⁾	5 / 3 ⁽¹⁾	4 / 3 ⁽¹⁾	2 / 0 ⁽¹⁾	3	7.5 / 4 ⁽¹⁾
2	82 x 12.5	125	7	5	4	3	2	7
3	80	80	4	3	3	2	1	7

(1) With LED system cover

Door frame kit

Cat.Nos 0 190 73/77

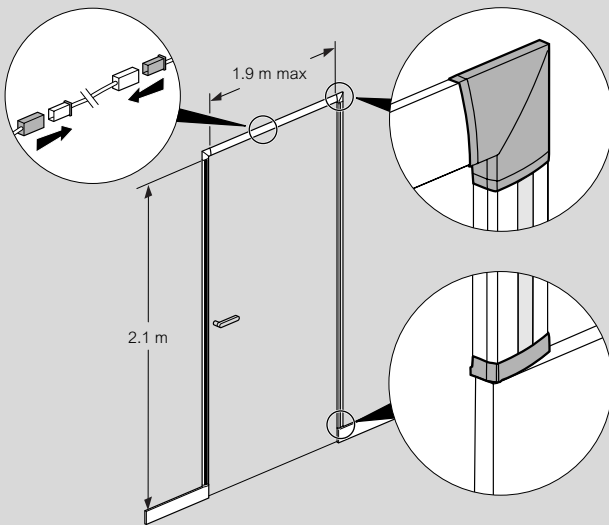

Finishing accessories

Changeable internal angle Cat.Nos 0 190 16/45

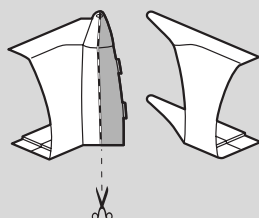
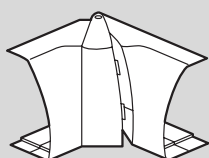
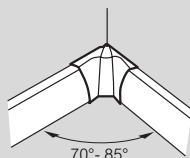
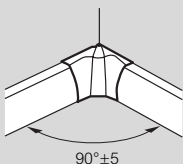

Finishing accessories (continued)

Changeable external angle Cat.Nos 0 190 12/43

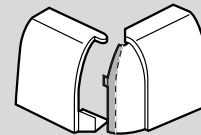
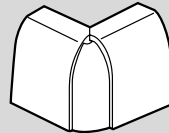
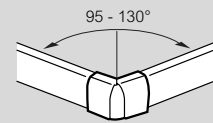
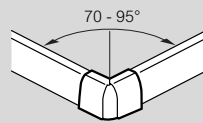

Note: the mini-trunking or plinth covers must be 4 mm shorter than the bodies in order to enable clipping the angles

Installation principle for drivers

Cat.No 0 190 90 - 10 W / maximum length 2 m

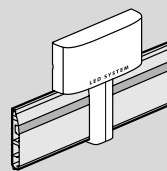

Surface mounting, alongside mini-trunking and plinths, with fixing accessory Cat.No 0 190 93

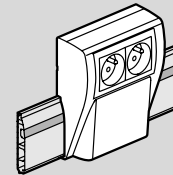

Surface mounting, alongside mini-trunking and plinths, with Mosaic/Arteor support frame Cat.No 0 190 78

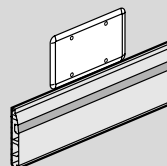

With Batibox flush-mounting box (2-gang), and cover Cat.No 0 801 82

Cat.No 0 190 91 - 35 W / maximum length 6 m

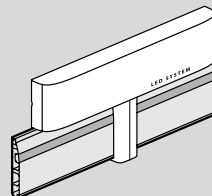

Surface mounting, alongside mini-trunking and plinths, with fixing accessory Cat.No 0 190 94

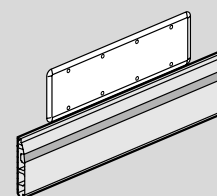

With Batibox flush-mounting box (4-gang), and cover Cat.No 0 190 96

LED system flush-mounting lighting modules

Installation principle for drivers (continued)

Cat.No 0 190 92 - 60 W / maximum length 10 m

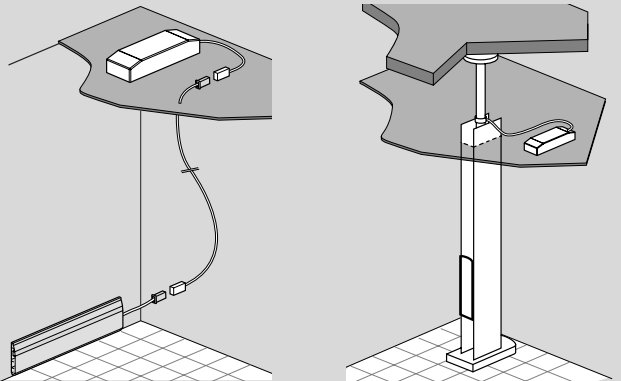

False ceiling installation and plinth

False ceiling installation and snap-on columns

Installation principle for drivers on 45 mm width covers

Cat.Nos 0 190 86/87/88

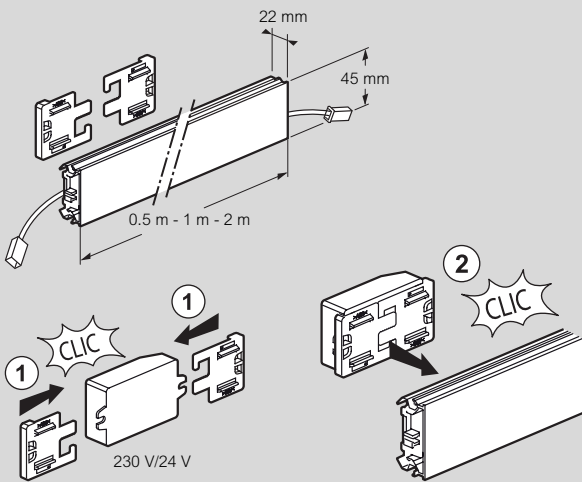

Installation on the backside of the 45 mm width LED cover
The fixing accessories are supplied with the cover

Wiring diagram

Cat.Nos 0 190 90/91/92

Input 220 V Output 24 V

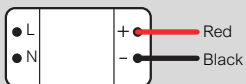

Cat.Nos	Consumption (W)	Maximum length (m)
0 190 90	10	2
0 190 91	35	6
0 190 92	60	10

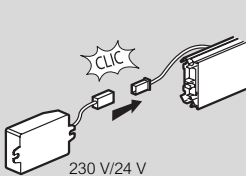

Fast connector between drivers and LED system covers

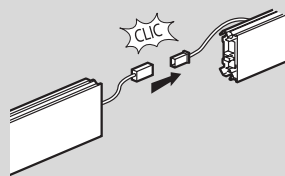

Fast connector between two LED system covers

Technical characteristics

Cat.Nos	Consumption (W)		Luminous flux (lm)	Luminous efficiency (lm/W)	Colour temperature (K)	IRC
	Lighting source	Total				
6 607 80/81/82	1.2	1.4	40	29	3000	80
6 607 83/84/85	4	4.2	300	71	4000	80
6 607 86/87	4	4.4	300	68	4000	80
6 607 88/89/90	7	7.2	600	83	4000	80
6 607 91/92	7	7.4	600	81	4000	80

Dimensions

Cat.Nos 6 607 80/81/82

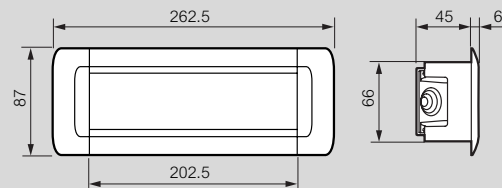

Cat.Nos 6 607 83/84/85/88/89/90

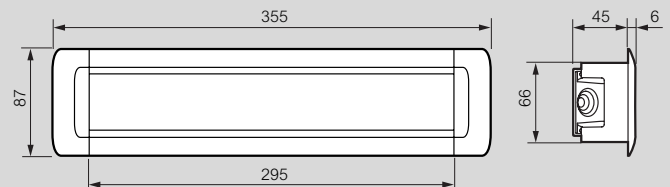

Cat.Nos 6 607 86/87/91/92

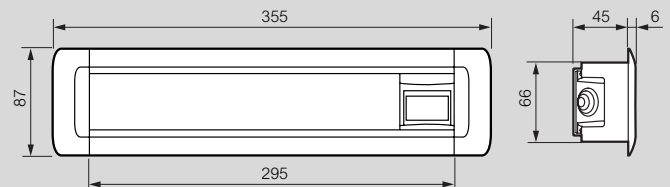

Cutting

Cat.Nos 6 607 80/81/82

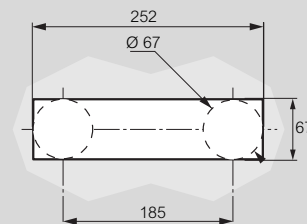

Cat.Nos 6 607 83/84/85/86/87/88/89/90/91/92

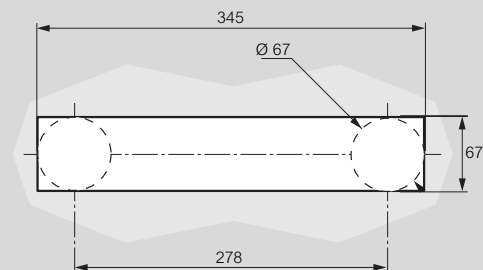



FOLLOW
US ON

@ www.legrand.com

 www.youtube.com/legrand

 [twitter.com/@legrand](https://twitter.com/legrand)



Head office

and International Department
87045 Limoges Cedex - France

Tel.: + 33 (0) 5 55 06 87 87

Fax: + 33 (0) 5 55 06 74 55