

# MegaLine<sup>®</sup> CABLING SYSTEMS COPPER



Data centres



Office



Industry



@home

# WELCOME TO THE MEGA STORE FOR CABLE AND SYSTEM SOLUTIONS

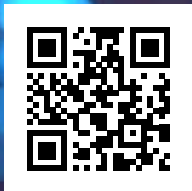

## **MegaLine®** CABLING SYSTEMS

Products and services on offer range from the production of own-brand copper data cables and assembled patch and trunk cables through to connection components and complete cable systems.

Everything from a single source » The Kerpen Datacom copper cable and connection technology product range provides future-proof cabling systems for data centres as well as horizontal and workplace cabling.

Issue: 2022 © KERPEN DATACOM GmbH

The contents of this catalogue are protected by copyright.

All rights reserved.

All necessary planning documentation is available online:

[www.kerpen-data.com](http://www.kerpen-data.com)

**Subject to technical modifications without notice. E&OE.**

#### Safety instructions

Cables are to be used for the designated applications only.

#### Waiver

The specifications in this document are provided to the best of our knowledge at the time of writing. However, these specifications must not be understood as an assurance of specific properties or suitability for specific purposes as regards the respective products. Such specifications must not be interpreted as an inducement to violate property rights or as an assurance of a corresponding licence. Product suitability for specific applications must be verified beforehand with our specialists. Our policy is one of continuous material and product development. We therefore reserve the right to offer alternatives consistent with our production range at the time of enquiry.

All information concerning material properties, fire performance, construction, electrical and technical data, prices etc. reflects our current level of knowledge and is provided on a non-binding basis. Dimensions and weights are indicative only. Specifications may be changed at any time without notice.

#### General conditions of sale and delivery

We refer to the currently valid General Conditions of Sale and Delivery which can be obtained from the respective companies.

	Page
<b>Intelligent solutions for energy and data management</b>	4
<b>Company profile</b>	
<b>Data communications and networks – profile</b>	5
<b>Strong brands, strong service</b>	6
<b>Technologies – an investment in sustainable safety</b>	7
<b>Environment and sustainability - REACH</b>	8
<b>MegaLine® copper data cables</b>	<b>10</b>
• SPACE concept	12
• PoE on the advance	19
• Fire-resistant cables	24
• Type codes	34
• Cable types and materials	35
• Product range	36
<b>MegaLine® Connect100 Copper connection technology</b>	<b>104</b>
• Introduction	106
• System overview (10 – 40 Gbit/s)	110
• Product range	112
<b>MegaLine® Connect45 Pro Copper connection technology</b>	<b>118</b>
• <b>MegaLine®</b> Connect45 Pro system overview (up to 10 Gbit/s)	122
• <b>MegaLine®</b> Connect45 Pro product range	124
<b>MegaLine® copper patch cords/trunk cables</b>	<b>128</b>
• <b>MegaLine®</b> copper patch cords/trunk cables product range	130
<b>VarioLine® System periphery in copper and FOC</b>	<b>144</b>
• <b>VarioLine®</b> CP – Consolidation Point range	147
• <b>VarioLine®</b> UF – underfloor systems	151
• System overview	152
• Product range	154
<b>Acceptance measurements</b>	<b>160</b>
Transmission classes	161
Alien crosstalk	162
<b>MegaLine® @home</b>	<b>164</b>
<b>Field of application</b>	<b>170</b>
Office	170
Industry	172
Data centres	176
Index	180
KERPEN DATACOM news	183

# INTELLIGENT SOLUTIONS FOR ENERGY AND DATA MANAGEMENT



Kerpenwerk was founded in Stolberg in 1919 and taken over by LEONI AG in 2006. Building on these activities, KERPEN DATACOM GmbH was established on 01 July 2021, producing and trading in passive data network components, such as copper and fibre optic data cables, RJ45 connectors, patch cables and data centre equipment. We provide complete passive cabling systems for superior data rates, reliability and processing capabilities. KERPEN DATACOM is one of the top 3 providers in this field in Germany.

The applications of our product range extend from building infrastructures to Industry 4.0.

LAN systems in offices, industry and data centres – all using Ethernet and Internet Protocol (IP) – are converging and transforming the communication landscape. KERPEN DATACOM GmbH also produces PVC compounds for the cable industry.



For further information see:  
[www.kerpen-data.com](http://www.kerpen-data.com)

## DATA COMMUNICATION & NETWORKS

Profile

# WE'RE TAKING THE SMART ROUTE

TO MANAGING BIGGER VOLUMES  
OF DATA.

We support our customers in creating digital networks with the power to innovate and visionary strategies designed to deliver high-performance components for global communication channels. In addition to digitalisation, efficient energy and data management, smart cities and the Internet of Things all pose new challenges. The future will be more and more about strategically directing and exploiting these data flows to improve our customer focus and generate new business models.

We're the experts in channelling data. Connectivity is our business. For over 40 years, we've been developing reliable, high-performance transmission systems for bigger bandwidth and higher speeds – and always with an eye on the application, the specification – and our customers worldwide. Today, our product portfolio covers the entire spectrum of transmission standards for data and communication networks.

This is the engine that drives our passion for intelligent data solutions. We get data to work for us and for you – for greater efficiency and long-term business success. We will use innovative products for continuous network monitoring and optimization, for eliminating potential bottlenecks and faults, and to ensure the optimum planning and configuration of your solution. We will use intelligent solutions to analyse network infrastructure, and to channel your data and energy more efficiently.

We're channelling data again – but this time, our smart data will be working for you.

LET'S USE DATA INTELLIGENCE TO GROW OUR  
BUSINESS TOGETHER.

STRONG BRANDS,  
STRONG SERVICE

## MegaLine®

COPPER CABLES AND SYSTEM TECHNOLOGY

## GigaLine®

FIBRE OPTIC CABLES AND SYSTEM TECHNOLOGY

## VarioLine®

MODULAR SYSTEM PERIPHERALS

## DClink

THE REAL PLUG & PLAY SOLUTIONS

Our commitment to developing innovative products shows we take our responsibilities seriously. We establish trust with our consulting services as we help our partners to achieve maximum safety for the people and infrastructures affected by their projects.

Installers and retail receive their cabling, connectivity and complete cabling solutions from a single source. These include system solutions for copper, aluminium and fibre optic technologies as well as halogen-free power cables with optional system integrity. Continuous innovations in safety, environmental compatibility and energy efficiency complete the list of customer benefits.

A global presence, local consulting services at all stages of a project, plus a wealth of project experience and far-reaching synergistic effects inside and outside the KERPEN DATACOM Group make us one of the most highly regarded international partners in the field of building and infrastructure cabling.



### FOR MAXIMUM DATA INTEGRITY AND BANDWIDTH

From the very beginning of the digital data era, we have fulfilled data networking requirements for both the short term and the far future by using great innovation and a forward-looking approach. Whether in structured building cabling for industry, data centres or offices – the sustainable copper and fibre optic cables from our own production are among the safest and most innovative products in the primary to tertiary cabling market.

# TECHNOLOGIES

Investments in sustainable safety

Universal use with extremely high system integrity

Our extensive production facilities use state-of-the-art methods and systems for processing plastics and materials, extrusion technology, electron beam irradiation crosslinking and for testing all of our products.

We use state-of-the-art production equipment to ensure that we can offer our customers the highest possible levels of product safety and quality. New and innovative polymer compounds and cables are in continuous development in our modern laboratories. Our focus here is on improved insulating properties, higher temperature tolerances, longer lifetimes, easy handling and better safety features.

Our laboratories for flammability testing, HF technology and optical measurement technology safeguard our quality standards and drive innovation forwards.

All of which has been demonstrated by the large number of approvals and certificates we have received from leading independent testing organisations worldwide.

In our fire test laboratory, the fire-resistant properties of our products are verified by certified testers, technicians and engineers. With this capability, we are able to carry out testing to fulfil the wide-ranging measuring tasks in accordance with BS 6387 C.W.Z. , IEC 60331-11/21 and DIN 4102 Part 12, as well as customer-specific specifications and special testing.

Numerous national and international certificates provide proof of our company's power to innovate.

- ▶ **Halogen free**  
IEC 60754-1, EN 50267-2-1
- ▶ **Corrosive effects of combustion gases**  
IEC 60754-2, EN 50267-2-2
- ▶ **Smoke density**  
IEC 61034, EN 61034
- ▶ **Flame retardancy**  
IEC 60332-1, EN 60332-1, VDE 0482-332-1
- ▶ **Circuit integrity**  
BS 6387 C.W.Z., DIN VDE 0472-814, EN 50200, EN 50362, IEC 60331-11/21, VdS 3423, VDE 0482-200
- ▶ **System integrity under fire**  
DIN 4102 part 12
- ▶ **Non-flame propagating**  
IEC 60332-3, EN 60332-3, VDE 0482-332-3 series
- ▶ **Construction Products Regulation**  
EN 50575, EN 50399, EN 60332-1
- ▶ **IT cabling systems for offices**  
EN 50173-2, ISO/IEC 11801
- ▶ **IT cabling systems for industry**  
EN 50173-3, ISO/IEC 24702
- ▶ **IT cabling systems for data centres**  
EN 50173-5, ISO/IEC 24764

Numerous national and international certificates confirm the company's ability to provide innovative solutions.

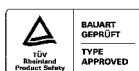

# COMBINING INNOVATION WITH SUSTAINABILITY.

ONE OF OUR COMPANY'S MOST IMPORTANT GOALS.

Our vision is to create sustainable connections in technological harmony with natural resources. The natural cycle offers us the perfect model to emulate here. It is our duty to learn from nature – to use its resources even as we conserve them for future generations. As natural resources grow scarcer and the burden on the environment increases, a rethink is required at all levels of our society. At KERPEN DATACOM, sustainability is an integral part of our corporate policy. We were the first cable manufacturer in the world to develop an integrated Green Technology programme.

While trends such as globalisation, mobility and urbanisation are crucial for market movements, our core principles are sustainability and global responsibility. This is why we have set ourselves the goal of becoming an innovative producer of cables for ecotechnology. Another point of vital interest for us is to identify the needs and requirements of tomorrow today, and to supply the markets of the future with future-proof and sustainable solutions. We also view it as our responsibility to take an active role in shaping the markets for environmentally-friendly energy production – such as solar thermal technology.

Green technology refers to producing cables from materials with very few pollutants while conserving resources and generating low levels of emissions. We constantly work at optimising the efficiency with which resources are used in

the manufacturing process by deploying energy-efficient machines or taking heat recovery measures.

In our worldwide operations as a leading European supplier of wires, optical fibres, cables and cable systems for communication and infrastructure projects, it is our responsibility to continuously optimise the sustainability and durability of our products, system solutions and services, so as to reduce their impact on the environment. We have to increase the amount of environmentally compatible raw materials in our cable products as well as the recyclability of processed materials or components, thereby creating end products that have been developed today for the environmental standards of tomorrow.

Together with ecological compatibility, future technologies are measured in terms of efficiency, service life, emission reduction and the conservation of natural resources. Innovative cable products and systems, integrated solutions and maximum performance in project management make up the added value that we offer to our customers and business partners. These are also our cornerstones for strong connections into the future.





**REACH** › Multiple environmental laws have been passed in the European Union (EU). Directive 2012/19/EU WEEE (Waste Electrical and Electronic Equipment) regulates the disposal of electrical and electronic equipment and components.

The use of certain hazardous substances in electrical and electronic equipment is regulated by Directive 2011/65/EU RoHS 2 (Restriction of Hazardous Substances).

Chemicals and substances in general are covered by Regulation 1907/2006/EC REACH (Registration, Evaluation, Authorisation and Restriction of Chemicals).

## REACH

**This means avoiding substances such as:**

- ▶ Polybrominated diphenyl ether (PBDE)
- ▶ Decabromodiphenyl ether (DecaBDE)
- ▶ Perfluorooctane sulfonate (PFOS)
- ▶ Pentabromodiphenyl ether (PentaBDE)
- ▶ Octabromodiphenyl ether (OctaBDE)
- ▶ Lead (Pb)
- ▶ Mercury (Hg)
- ▶ Cadmium (Cd)
- ▶ Hexavalent chromium (Cr VI)
- ▶ Polybrominated biphenyls (PBB)

Cables, wiring and their associated connectors are governed by the EU WEEE Directive (2012/19/EU) only if they are an internal part of the equipment and components listed.

Cables and conductors have been regulated separately in 2011/65/EU RoHS 2 since 2013 (category 11 or defined as an internal component of the respective product). Optical fibre cable, power cables (> 250 V) and permanently installed cables (e.g. in buildings) are not affected. The only permissible marking according to RoHS 2 is the CE marking, which is printed on the product package.

- ▶ EU Directive 2012/19/EU on waste electrical and electronic equipment.
- ▶ EU Directive 2011/65/EU on the restriction of the use of certain hazardous substances in electrical and electronic equipment.
- ▶ EU Regulation 1907/2006/EC (REACH), the European Union's chemicals regulation.

### What does REACH mean?

REACH stands for Registration, Evaluation, Authorisation and Restriction of Chemicals.



































REACH represents a fundamental harmonisation and simplification of previous chemical legislation and applies in all EU member states.

REACH introduced a candidate list of substances of very high concern (SVHC). These are subject to certain information requirements and should be substituted in the long term. The list of candidate substances is updated twice yearly by the European Chemicals Agency (ECHA) in Helsinki.

# MegaLine® COPPER DATA CABLE



MegaLine® copper data cables	Page
<b>Space concept</b>	<b>12</b>
SPACE – Security	13
SPACE – Performance	14
SPACE – Application	16
SPACE – Construction	17
SPACE – EMC	18
<b>PoE on the advance</b>	<b>19</b>
Benefits of PoE	20
Energy feed-in variants	21
<b>Fire protection cable in accordance with the EU Construction Products Regulation</b>	<b>24</b>
Safety in the event of a fire	25
Fire safety of cable systems	26
CE marking and declaration of performance	27
Fire classes and certificate of conformity	28
Overview of fire testing	29
Cable types with Euroclass B2 <sub>ca</sub> s1a d1 a1	31
On the safe side with KERPEN DATACOM	32
Data cable colour code according to CPR classes	33
<b>Type codes</b>	<b>34</b>
<b>Cable types and materials</b>	<b>35</b>

MegaLine® copper data cables		from page							
		Simplex	Duplex	B2 <sub>ca</sub>	C <sub>ca</sub>	E <sub>ca</sub> /D <sub>ca</sub>			
	<b>MegaLine® G20 S/F</b>	◆		◆	◆	◆	Cat. 8.2	Class F <sub>A</sub> +	36
	<b>MegaLine® G20 S/F Mini</b>	◆					Cat. 8.2	Class F <sub>A</sub> +	38
	<b>MegaLine® G12-150 S/F</b>	◆	◆	◆	◆	◆	Cat. 7 <sub>A</sub> +	Class F <sub>A</sub> +	40
	<b>MegaLine® F10-130 S/F</b>	◆	◆	◆	◆	◆	Cat. 7 <sub>A</sub>	Class F <sub>A</sub>	42
	<b>MegaLine® F10-125 S/F</b>	◆	◆	◆	◆	◆	Cat. 7 <sub>A</sub>	Class F <sub>A</sub>	44
	<b>MegaLine® F10-115 S/F</b>	◆	◆	◆	◆	◆	Cat. 7 <sub>A</sub>	Class F <sub>A</sub>	46
	<b>MegaLine® F6-90 S/F</b>	◆	◆	◆	◆	◆	Cat. 7	Class F	48
	<b>MegaLine® F6-90 S/F CI</b>	◆					Cat. 7	Class F	50
	<b>MegaLine® E5-70 S/F</b>	◆	◆			◆	Cat. 6 <sub>A</sub>	Class E <sub>A</sub>	52
	<b>MegaLine® E5-70 F/F</b>	◆	◆	◆	◆	◆	Cat. 6 <sub>A</sub>	Class E <sub>A</sub>	54
	<b>MegaLine® E5-60 U/F</b>	◆	◆			◆	Cat. 6 <sub>A</sub>	Class E <sub>A</sub>	56
	<b>MegaLine® E2-45 U/F</b>	◆	◆			◆	Cat. 6	Class E	58
	<b>MegaLine® E2-30 U/U</b>	◆				◆	Cat. 6	Class E	60
	<b>MegaLine® D1-20 SF/U</b>	◆	◆			◆	Cat. 5	Class D	62
	<b>MegaLine® Pro 1500</b>	◆	◆			◆	Cat. 7 <sub>A</sub> +	Class F <sub>A</sub>	64
	<b>MegaLine® Pro 1300</b>	◆	◆			◆	Cat. 7 <sub>A</sub>	Class F <sub>A</sub>	66
	<b>MegaLine® Pro 1000</b>	◆	◆			◆	Cat. 7	Class F	68
	<b>MegaLine® G20 S/F Flex</b>	◆				◆	Cat. 8.2	Class F <sub>A</sub> +	70
	<b>MegaLine® F10-120 S/F Flex</b>	◆				◆	Cat. 7 <sub>A</sub>	Class F <sub>A</sub>	72
	<b>MegaLine® F6-90 S/F Flex</b>	◆				◆	Cat. 7	Class F	74
	<b>MegaLine® D1-20 SF/U Flex</b>	◆					Cat. 5	Class E <sub>A</sub>	76
	<b>MegaLine® F10-130 S/F (L)2Y</b>	◆					Cat. 7 <sub>A</sub>	Class F <sub>A</sub>	78
	<b>MegaLine® F10-130 S/F QH</b>	◆					Cat. 7 <sub>A</sub>	Class F <sub>A</sub>	80
	<b>MegaLine® F10-130 S/F Vö</b>	◆				◆	Cat. 7 <sub>A</sub>	Class F <sub>A</sub>	82
	<b>MegaLine® F6-90 S/F Vö</b>	◆				◆	Cat. 7 <sub>A</sub>	Class F <sub>A</sub>	84
	<b>MegaLine® F10-115 S/F V</b>	◆				◆	Cat. 7 <sub>A</sub>	Class F <sub>A</sub>	86
	<b>MegaLine® F6-90 S/F 2Y</b>	◆					Cat. 7	Class F	88
	<b>MegaLine® D1-20 SF/U 2Y</b>	◆					Cat. 5	Class D	90
	<b>MegaLine® F10-120 S/F 11Y Flex</b>	◆					Cat. 7 <sub>A</sub>	Class F <sub>A</sub>	92
	<b>MegaLine® F6-90 S/F 11Y Flex</b>	◆					Cat. 7	Class F	94
	<b>MegaLine® D1-20 S/U 11Y Superflex</b>	◆					Cat. 5	Class D	96
	<b>MegaLine® SPE AWG 26/7</b>	◆					Cat. 7	Class E	98
	<b>MegaLine® SPE AWG 22/7</b>	◆					Cat. 7	Class E	100
	<b>MegaLine® Slim 600</b>	◆				◆	Cat. 7	Class F	102



Office cables



Data centre cables



Industrial cables



MegaLine® @home cable (smart home)

# SPACE CONCEPT

Finding the right data cable

KERPEN DATACOM's SPACE concept is based on a practical and clearly structured matrix. This decision-making aid will help you to find the right data cable for your application faster.



Security

Performance

Application

Construction

EMC

## SPACE MATRIX:

Security (fire behaviour)

S	1 IEC 60332-2-2	2 IEC-60332-1-2	3 IEC-60332-3-24	4 EFP Grade 1	5 EFP Grade 2
		E <sub>ca</sub> /D <sub>ca</sub>	E <sub>ca</sub> /D <sub>ca</sub>	C <sub>ca</sub>	B2 <sub>ca</sub>

The concept is based on the classification of the five main selection criteria for determining the potential overall performance of a data cable:

Security · Performance · Application · Construction · EMC

It also allows value for money to be assessed and makes room for alternative technical and economic scenarios. The higher the SPACE index, the greater the demands made on the segment in question.

Example of a data cable with the code S<sub>3</sub>P<sub>4</sub>A<sub>4</sub>C<sub>5</sub>E<sub>5</sub>:

S<sub>3</sub> It passes the fire test according to IEC 60332-3-24 (security level 3)

P<sub>4</sub> It meets the minimum requirements for Class F<sub>A</sub> (performance level 4)

A<sub>4</sub> It is designed for applications using more than 10 GbE (application level 4)

C<sub>5</sub> It consists of an AWG 22 conductor (construction level 5) and thus has low attenuation values and an increased max. current

E<sub>5</sub> The coupling attenuation is > 80 dB (EMC level 5)

Performance (cabling class, bandwidth)

P	1 > Class E > 250 MHz	2 > Class E <sub>A</sub> > 500 MHz	3 > Class F > 600 MHz	4 > Class F <sub>A</sub> > 1000 MHz	5 > Class F <sub>A</sub> + > 1200 MHz
---	-----------------------------	--	-----------------------------	---	---

Application (Ethernet, TV)

A	1 > 100 MbE	2 > 1 GbE	3 Up to 10 GbE	4 > 10 GbE	5 > 10 GbE TV
---	----------------	--------------	-------------------	---------------	------------------

Construction (conductor dimension, tensile strength)

C	1 AWG 27	2 AWG 26/25	3 AWG 24	4 AWG 23	5 AWG 22
---	-------------	----------------	-------------	-------------	-------------

EMC (coupling attenuation)

E	1 > 40 dB	2 > 50 dB	3 > 60 dB	4 > 70 dB	5 > 80 dB
---	--------------	--------------	--------------	--------------	--------------



## SPACE – SECURITY

### Fire behaviour

As a result of the constant increase in the installed basis and the installation density, the fire behaviour of data cables is an important safety criterion. When manufactured according to the legal regulations and installed correctly, data cables cannot cause a fire. If they do catch fire, however, they can ignite and spread the fire.

One of the aims here is to prevent the propagation of fire and the resulting damage by using flame-retardant, halogen-free cable designs.

#### Security (fire behaviour)

S	1 IEC 60332-2-2	2 IEC-60332-1-2	3 IEC-60332-3-24	4 EFP Grade 1	5 EFP Grade 2
		E <sub>ca</sub> /D <sub>ca</sub>	E <sub>ca</sub> /D <sub>ca</sub>	C <sub>ca</sub>	B2 <sub>ca</sub>

The five security levels with regard to fire propagation/flame retardancy:

#### S<sub>1</sub> IEC 60332-2-2

Test for vertical fire propagation in a single wire or a single cable. Test method: incandescent flame.

#### S<sub>2</sub> IEC 60332-1-2

Test for vertical fire propagation in a single wire or a single cable. Test method: 1 KW flame. Flame is applied to the lower area of a vertical sample of the cable, about 60 cm long, for about 60 seconds using some type of Bunsen burner. After removal of the burner, the flames must go out by themselves. The parts of the cable damaged by the flames must not reach its upper end (distance: 50 mm).

#### S<sub>3</sub> IEC 60332-3-24

Flame propagation is tested using an arrangement of several cables (a cable bundle) according to IEC 60332-3-24. In this cable bundle test, a flame is applied to the lower part of the test samples on a vertical ladder with a length of 360 cm using a high-performance burner. During and after intensive application of the flame for a test period of 20 minutes, the cables must not burn higher than 250 cm.

#### MegaLine® data cables have improved fire protection characteristics:

- ▶ Extremely low smoke generation in accordance with IEC 61034
  - ▶ Facilitation of rescue and salvage operations
- ▶ Low toxicity (no dioxins are produced)
  - ▶ Reduced risk of poisoning
- ▶ Halogen-free in accordance with IEC 60754-2
  - ▶ No consequential damage to property due to corrosion
- ▶ Low fire load values
  - ▶ Flame spread is limited
- ▶ High oxygen index (OI up to 45)
  - ▶ Reduced flammability



#### S<sub>4</sub> EFP (enhanced fire performance) grade 1

In this cable bundle test, a flame is applied to the lower part of the test samples fixed on a vertical ladder test rig 360 cm long using a high-performance burner. During and after intensive application of the flame for a test period of 20 min, the length of the burned section must not exceed approx. 1 m. Immediately after removal of the flame, the self-extinguishing process must start. Only specially designed data cables can withstand this exacting fire test.

#### S<sub>5</sub> EFP (enhanced fire performance) grade 2

This stricter security level is application-specific.

Security levels **S<sub>3</sub>**, **S<sub>4</sub>** and **S<sub>5</sub>** are particularly relevant for applications where high/highest security measures are required to protect people or valuable material assets. For instance hospitals, schools, hotels, airports, railway stations, departments stores, power and electricity plants, data centres, banks, insurance companies and alarm systems.



## SPACE – PERFORMANCE

Cabling class / bandwidth



### Performance (cabling class, bandwidth)

P	1	2	3	4	5
	>Class E	>Class E <sub>A</sub>	>Class F	>Class F <sub>A</sub>	>Class F <sub>A</sub> +
	>250 MHz	>500 MHz	>600 MHz	>1000 MHz	>1200 MHz

The five performance classes (cabling class, bandwidth) offer generous reserves compared to the relevant standards.

Building cabling systems are expected to have a service life of 10 to 15 years. This requires far-sighted planning of the required performance of cabling systems and their components.

International standards have often fallen short due to the the exacting compromises they are forced to make and in light of rapidly increasing transmission rates. Since the development of 10 Gigabit Ethernet, none of the cabling classes below Class F can be said to meet the demands of the future.

**MegaLine®** data cables provide excellent transmission performance. They offer high security reserves and are always one step ahead of the standard. **MegaLine®** – the investment with a future.

### P<sub>3</sub> better than Class F (600 MHz)

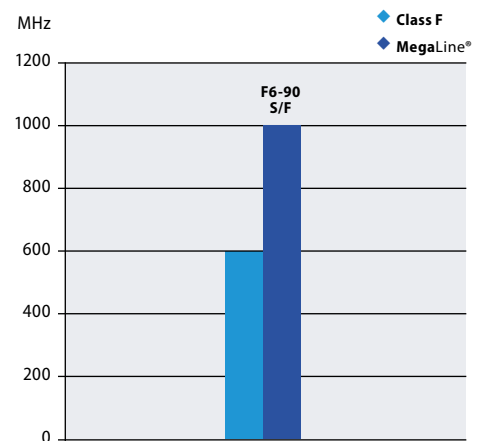

#### Example: **MegaLine®** F6-90 S/F

Better than Category 7 according to EN 50288 and IEC 61156  
excellent NEXT, excellent shielding characteristics  
(pairs and overall shielding), low skew

### P<sub>1</sub> better than Class E (250 MHz)

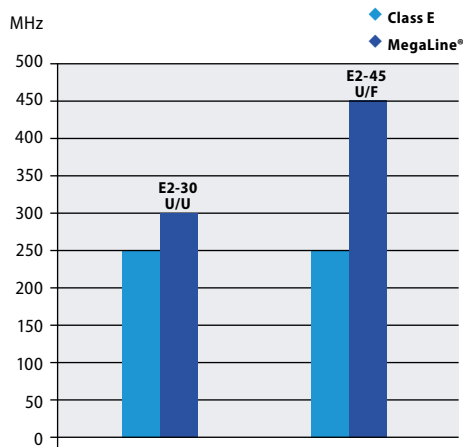

Example: **MegaLine® E2-45 U/F**

Better than Category 6 according to EN 50288 and IEC 61156, excellent NEXT, low skew

### P<sub>2</sub> better than Class E<sub>A</sub> (500 MHz)

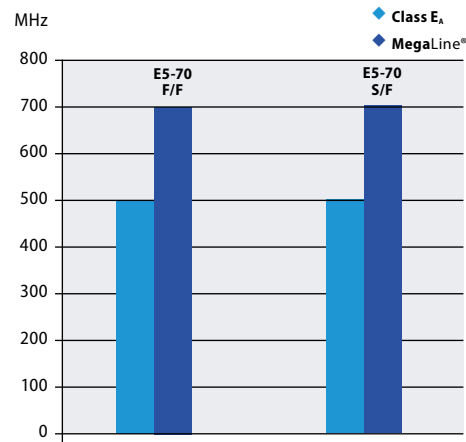

Example: **MegaLine® E5-70 S/F**

Better than Category 6<sub>A</sub> according to EN 50288 and IEC 61156 very good NEXT, very good shielding characteristics (pairs and overall shielding), low skew

### P<sub>4</sub> better than Class F<sub>A</sub> (1000 MHz)

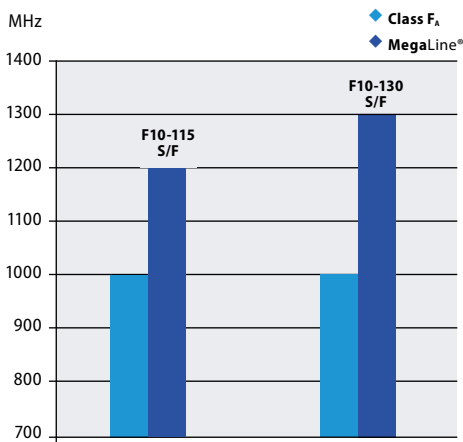

Example: **MegaLine® F10-130 S/F**

Better than category 7<sub>A</sub> according to EN 50288 and IEC 61156, excellent NEXT, low attenuation, excellent shielding characteristics (pairs and overall shielding), low skew

### P<sub>5</sub> better than Class F<sub>A+</sub> (1200 MHz)

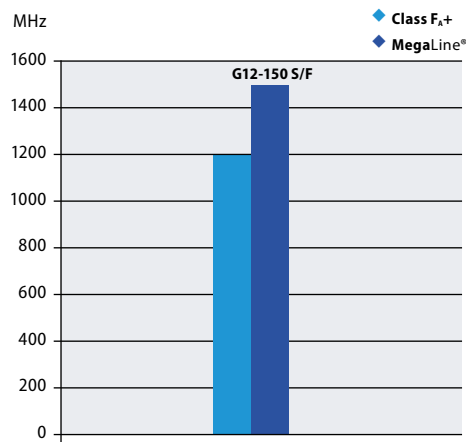

Example: **MegaLine® G12-150 S/F**

Better than Category 7<sub>A</sub> according to EN 50288 and IEC 61156, excellent NEXT, lowest attenuation, excellent shielding characteristics (pairs and overall shielding), low skew



## SPACE – APPLICATION

Ethernet/TV



Large safety margins mean that multimedia applications can be transmitted over 100 m, for instance TV and bandwidth-hungry transmission protocols, such as 10 Gigabit Ethernet and 8 Gigabit Fibre Channel. Experts have calculated that, as far as we know today, **MegaLine®** Category 7<sub>A</sub> data cables allow transmission rates of up to 100 Gbit/s.

The use of low-loss broadband S/FTP cables with individual or overall shielding in multimedia cabling systems also allows cable-sharing or service-sharing systems to be configured. Cables and connectors form a perfect symbiosis: 4 pairs, 4 connecting clips – each with GHz performance. This allows parallel, simultaneous use of different applications via one cable and one connector: data, voice and images.

Multimedia systems do not need to cost more than conventional systems, in which an individual cable and an individual connector is usually required for each service. This allows savings of up to 50 % of the necessary cables, connectors, wall outlets and patch panels.

Multiple use reduces system costs by 15% to 30% (depending on the services used). The reduction in the number of cables and wall outlets actually required usually also lowers the cost of cable ducts, switch cabinets etc.

But **MegaLine®** data cables are capable of much more

They can supply current (up to 350/600 mA) and voltage (up to 48 V) via PoE/PoE+ (according to IEEE 802.3a/at). The current is fed in centrally via the floor distributor or switch. Devices such as IP telephones, web cameras, wireless LAN access points, etc. are supplied via the telecommunications outlet. The voltage is tapped via a phantom circuit or two unassigned pairs.

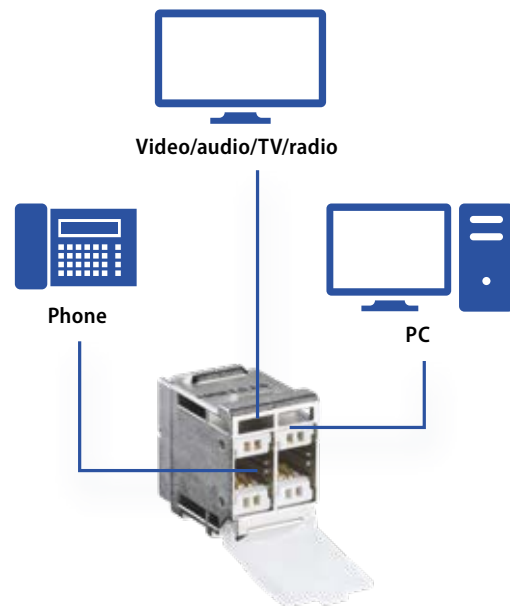

Application (Ethernet, TV)

A	1	2	3	4	5
	> 100 MbE	> 1 GbE	Up to 10 GbE	> 10 GbE	> 10 GbE TV

The SPACE concept provides five different application levels.

**A<sub>1</sub>** > 100 Mbit/s (Fast Ethernet) IEEE 802.3u

**A<sub>2</sub>** > 1000 Mbit/s (Gigabit Ethernet) IEEE 802.3ab

**A<sub>3</sub>** ≤ 10,000 Mbit/s (10 Gigabit Ethernet) IEEE 802.3an

**A<sub>4</sub>** > 10,000 Mbit/s (10 Gigabit Ethernet) IEEE 802.3an

**A<sub>5</sub>** > 10,000 Mbit/s (10 Gigabit Ethernet) and TV  
IEEE 802.3an and multimedia





## SPACE – CONSTRUCTION

### Conductor dimension



High-precision conductor and core geometries, optimally matched lay lengths in the pairs and the use of very high-quality insulation and sheath materials are the characteristic features of our range of cables.

Our cables are produced on ultra-modern equipment which corresponds with the "state of the art" as a result of procedural innovations. The use of physical foaming in the manufacture of high-frequency cores allows excellent, uniform electrical and geometrical characteristics to be achieved. Double skin layers ensure excellent mechanical stability while patented stranding techniques demonstrate technical leadership.

The designs have low outer diameters, thus allowing high packing densities and small bending radii. The weight reductions and the robust cable construction offer advantages for assembly and installation, even under difficult conditions.

**The five different conductor classes describe the permitted tensile stress during installation and the conductor resistance.**

Note ① The copper sales factor is a purely commercial calculation factor that is used to calculate the total price of a cable. Although usually expressed in the trade in kg/km, the copper sales factor does not indicate the quantity or weight of the actual copper contained in the cable.

It is a purely arithmetic calculation factor that does not give any direct indication of the amount of copper used in the cable.

#### Construction (conductor dimension, tensile strength)

C	1 AWG 27	2 AWG 26/25	3 AWG 24	4 AWG 23	5 AWG 22
---	-------------	----------------	-------------	-------------	-------------

It can be used to derive the current-carrying capacity values for a maximum ambient temperature of +60°C and the maximum installation lengths in the transmission channel (on request).

**C<sub>1</sub> AWG 27 (7x0.14 mm/0.112 mm<sup>2</sup>)**  
Tensile strength: max. 40/20 N (4P/2P)  
Conductor resistance: max. 170 Ω/km

**C<sub>2</sub> AWG 26 or AWG 25**

- ▶ **C<sub>21</sub> AWG 26 (7x0.16 mm/0.14 mm<sup>2</sup>)**  
Tensile strength: max. 60/30 N (4P/2P)  
Conductor resistance: max. 145 Ω/km
- ▶ **C<sub>22</sub> AWG 25 (7x0.18 mm/0.175 mm<sup>2</sup>)**  
Tensile strength: max. 70/35 N (4P/2P)  
Conductor resistance: max. 120 Ω/km

**C<sub>3</sub> AWG 24 (0.51 mm/0.205 mm<sup>2</sup>)**  
Tensile stress: max. 90/45 N (4P/2P)  
Conductor resistance: max. 95 Ω/km

**C<sub>4</sub> AWG 23 (0.57 mm/0.258 mm<sup>2</sup>)**  
Tensile stress: max. 110/55 N (4P/2P)  
Conductor resistance: max. 75 Ω/km

**C<sub>5</sub> AWG 22 (0.64 mm/0.325 mm<sup>2</sup>)**  
Tensile stress: max. 130/65 N (4P/2P)  
Conductor resistance: max. 57 Ω/km



## SPACE – EMC

### Coupling attenuation

#### Electromagnetic compatibility (EMC)

This refers to the ability of devices, systems and plants to function satisfactorily in an electromagnetic environment. without negative effects on other devices, systems or plants. EMC legislation prescribes the electromagnetic compatibility of devices, systems and plants. The limits for interference emissions and immunity that must be adhered to are specified in EN 55022 (Class B) and EN 50082-1/2 or EN 55024.

A data cable must resist electromagnetic influences coming from the outside to the inside (immunity to interference) and from the inside to the outside (emission of interference). The susceptibility of data cable systems to interference increases in step with the transmission frequency and the data rates (currently 10 Gigabit Ethernet).

Electromagnetic compatibility			
Structure	U/UTP	F/UTP	S/FTP
Symmetrical characteristics	+++	++	++
Shield characteristics	low	+	+++
Installation environment influence	high	moderate	low

The main danger is increasingly a result of the alien crosstalk between adjacent data cables. Depending on their construction, data cables have different capabilities with regard to the prevention or reduction of interference.

- ▶ **Unshielded data cables have very good symmetry characteristics but are not shielded against internal, external or adjacent sources of interference. They are greatly endangered by the environment in which they are installed.**
- ▶ **Data cables with individual or overall shielding have very good symmetry characteristics and good or even very good shield characteristics. The EMC is very good or even excellent. Interference coming from the installation environment (adjacent data cables) can be ruled out completely.**

Double-shielded MegaLine® data cables achieve values of > 80 dB to 1000 MHz and thus suppress incoming or outgoing interference potentials by a factor of > 10,000. Cables with individual and overall shielding (S/FTP) have excellent EMC, making them an obvious choice for the fail-safe transmission of high data rates such as those offered by 10 Gigabit Ethernet.



#### EMC (coupling attenuation)

E	1	2	3	4	5
	> 40 dB	> 50 dB	> 60 dB	> 70 dB	> 80 dB

The KERPEN DATACOM MegaLine® SPACE concept offers five different EMC levels.

The evaluation criterion is their coupling attenuation (interference power suppression). As the sum of the shielding attenuation and the symmetry attenuation, coupling attenuation is the essential measurement used to assess and compare the overall EMC behaviour of different types of data cable.

#### E<sub>1</sub> Coupling attenuation > 40 dB

Interference suppression exceeding a factor of 100

#### E<sub>2</sub> Coupling attenuation > 50 dB

Interference suppression exceeding a factor of 300

#### E<sub>3</sub> Coupling attenuation > 60 dB

Interference suppression exceeding a factor of 1,000

#### E<sub>4</sub> Coupling attenuation > 70 dB

Interference suppression exceeding a factor of 3,000

#### E<sub>5</sub> Coupling attenuation > 80 dB

Interference suppression exceeding a factor of 10,000

# POE (POWER OVER ETHERNET)

Power distribution to many kinds of network-capable devices via LAN cable

This dual-purpose use of the copper cable for data and energy transmission is becoming increasingly popular. Particularly since it avoids the need for a separate power cable. More and more users are now using this technology, termed Power over Ethernet (PoE).

#### Benefits

- ▶ 230 V power cable no longer required
- ▶ Minimises cable clutter
- ▶ Saves space and reduces installation costs

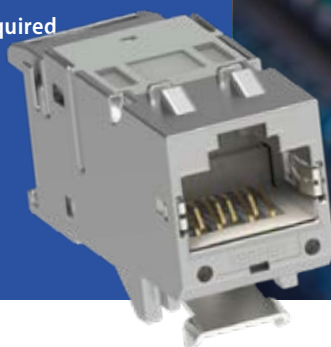

## CURRENT IEEE STANDARDS

### ▶ From 2003

#### IEEE 802.3af-2003

##### Power over Ethernet (PoE)

This is the first standard to specify power distribution over the data cable for Ethernet devices, with a nominal power of 15.4 W. Maximum amperage is 175 mA per conductor or 350 mA per pair.

### ▶ From 2009

#### IEEE 802.at-2009

##### Power over Ethernet Plus (PoE+/PoE Plus)

With this standard from 2009, the power rating is as much as 30 W and is fed in using an amperage of 600 mA per pair.

### ▶ From 2018

#### IEEE 802.3bt-2018

##### Four-Pair Power over Ethernet (PoE++/4PPoE)

Issued in 2018, the most recent standard provides a much higher rate of power distribution to Ethernet devices. Here, there are four levels from 40 to 72 W. This improvement provides for larger output ratings for power distribution, with a maximum of 55 W (level 3) and 100 W (level 4). This results in a usable power output of 40 to 72 W directly at the consumer.

##### Huge range of applications

For private use (e.g. smart homes), office equipment (e.g. smart offices) or for industrial installations (e.g. sensors, meters, controllers). Including VoIP phones, IP cameras, WLAN access points, network routers, VoIP phones, network switches or IP cameras.

Select the power class to match the specific application. A quick overview:

	PoE	PoE+	PoE++ / 4PPoE	PoE++ / 4PPoE
PoE standard	IEEE 802.3af-2003	IEEE 802.3at-2009	IEEE 802.3bt-2018	IEEE 802.3bt-2018
Type	Type 1	Type 2	Type 3	Type 4
Useful power for the PD	3.84–6.5 W	12.95–25.5 W	40–51 W	62–72 W
Power from power sourcing equipment	4–7 W	15–30 W	40–51 W	75–90 W
Adjusted supply voltage	44 V	50 V	50 V	52 V
Max. current/pair	350 mA	600 mA	600 mA	720–860 mA
Number of pairs	2	2	4	4

## BENEFITS OF POE TECHNOLOGY

The PoE-capable switch used (power sourcing equipment – PSE) offers enormous benefits in conjunction with PoE-capable end devices (powered devices – PD):

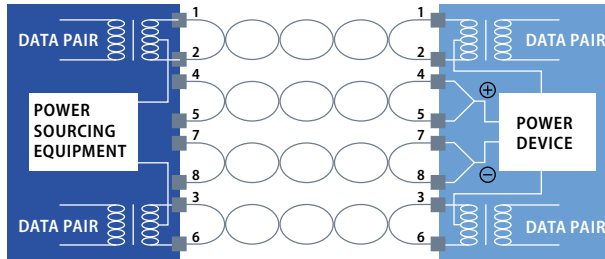

Schematic diagram of a PoE circuit (from IEC 62652)

- ▶ **Eliminates the need for a 230-V power supply (cable and outlet)**
- ▶ **Worldwide compatibility thanks to (international standardisation)**
- ▶ **Comprehensive management and monitoring options**
- ▶ **Reduction of energy costs by routing energy to where it is needed and switching off unused ports**
- ▶ **Fail-safe thanks to central, uninterrupted power supply (UPS).**

## NEW REQUIREMENTS FOR POE

PoE was originally developed for conventional telephony, in order to provide phones with power via their connection cables. New deployment options have now arisen, however, thanks to the improved performance offered by PoE+ and PoE++. New megatrends – with an endless stream of new user devices and applications – are also powerful drivers of improvement.

**These include the IoT (Internet of Things), Smart Grid, Smart Home, building automation and control systems and Industry 4.0.**

And these are just some of the areas that stand to benefit from these developments. An annual growth rate of up to 12 percent is now being forecast for this market.

### PoE (15 W)

- ▶ IP telephones
- ▶ IP cameras
- ▶ Wireless LAN access points
- ▶ Bluetooth access points

### PoE (30 W)

- ▶ Devices for the high-speed WLAN standard IEEE 802.11n
- ▶ Outdoor IP camera with heating, pan, tilt and zoom functions
- ▶ Access control systems with controller, reading devices and lock system
- ▶ Video IP telephone

### 4PPoE Four-Pair power supply (up to 100 W)

- ▶ Nursing call system in the healthcare sector
- ▶ Credit card readers and printers, e.g. in retail applications
- ▶ Laptops, thin-client computers
- ▶ Illumination (LED)
  - ▶ Temperature and humidity sensors
  - ▶ Camera surveillance
  - ▶ Security systems
- ▶ Industrial applications

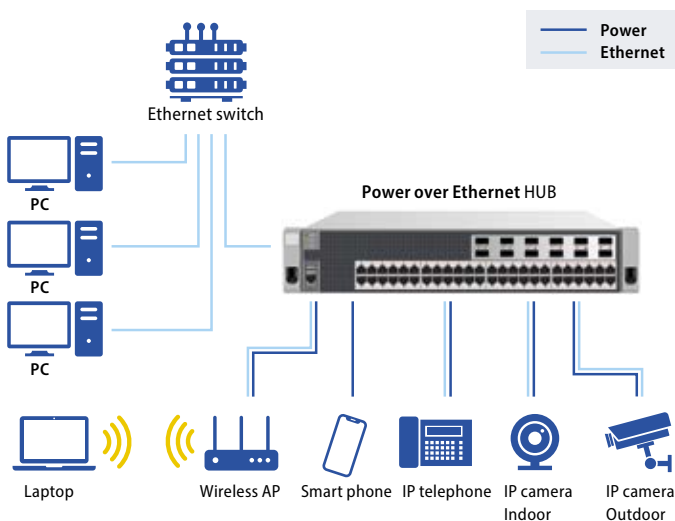

Examples of PoE applications

## ENERGY FEED-IN VARIANTS

There are two options for transferring current between the power sourcing equipment (PSE) and the powered device (PD):

### ► Spare pairs method

With this variant, only the unused conductor pairs (4/5 and 7/8) are used for delivering power from the PSE to the PD.

### ► Phantom feeding (or remote supply)

This variant uses all data-carrying conductors to supply power (according to the IEEE 802.3bt-2018 (4PPoE) standard).

This means a voltage modulation occurs simultaneously with data transfer. Power levels can now be as high as 90 W with a maximum amperage of 860 mA.

### Important considerations

Data cabling was not originally designed for energy transmission at all. Nonetheless, dual use as desired is possible if the defined framework conditions are taken into account and suitable components selected.

**The following points must be taken into account, however:**

#### ►► Overheating of the data cable

The increased power levels involved with the use of PoE, combined with cable accumulation in the installation duct and poor heat dissipation, can lead to perceptible increases in temperature in the data cables, potentially rising to dangerous levels in extreme cases.

Cable heating depends on the following factors:

- Current load (depending on the PoE standard used)
- Cable design (in particular conductor cross-section)
- Number of cable bundles in the installation channel
- Installation environment (heat release)
- ambient temperature

The higher the category, the larger the conductor cross-section, the less the direct current resistance and therefore the less heat loss, too.

In the example shown taken from ISO/IEC TR 29125, category 7<sub>A</sub> cables exhibit 36 per cent lower heating than category 5 data cables.

The correct cable design makes a crucial contribution in minimising cable warming.

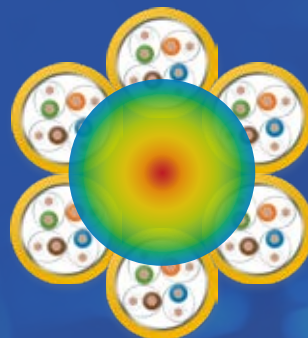

*Cables heat from the inside to the outside*

The rule of thumb is:

**The higher the category, the lower the amount of heating**

Cable warming based on cable category (from ISO/IEC TR 29125)					
Size of cable bundle (no. of cables)	Temperature increase in C°				
	CAT 5	CAT 6	CAT 6 <sub>A</sub>	CAT 7	CAT 7 <sub>A</sub>
1	0.8	0.6	0.6	0.6	0.6
7	1.4	1.1	1.0	1.0	0.9
19	2.6	2.1	1.8	1.8	1.6
37	4.7	3.7	3.2	3.2	2.9
61	6.9	5.5	4.8	4.8	4.4
91	9.7	7.7	6.7	6.7	6.2
127	13.1	10.4	9.0	9.0	8.3
169	16.9	13.5	11.7	11.7	10.8

**-36%**

## ▶▶ INCREASED ATTENUATION

Another generally neglected effect is the increase in attenuation – caused by the rise in temperature and the reduction in range which this derives from. This can lead to incorrect transmission and in extreme cases result in system failure. Here, shielded data cables offer clear benefits over unshielded data cables due to the lower temperature coefficient.

### Example 1 – unshielded

#### Class D<sub>s</sub> at 60°C with Cat. 5 cable UTP

$$H_{60^{\circ}\text{C}} = (109 \text{ m} - 10 \times 1.5 \text{ m}) - (0.4/100 \times 20 \times 94 \text{ m}) - (0.6/100 \times 20 \times 94 \text{ m}) = 75 \text{ m}$$

### Example 2 – shielded

#### Class D<sub>s</sub> at 60°C with Cat. 5 cable STP

$$H_{60^{\circ}\text{C}} = (109 \text{ m} - 10 \times 1.5 \text{ m}) - (0.2/100 \times 40 \times 94) = 86 \text{ m (+15%)}$$

### Equation for horizontal transmission links

#### Increase in attenuation and reduction in range depending on temperature and cable design (from EN 50173)

Model	Model equation		
	Class D	Class E and E <sub>A</sub>	Class F and F <sub>A</sub>
a) Through connection TO	$H = 109 - F \times X$	$H = 107 - 3 - FX$	$H = 107 - 2 - F \times X$
b) Marshalling TO	$H = 107 - F \times X$	$H = 106 - 3 - FX$	$H = 106 - 2 - F \times X$
c) Through connection SP – TO	$H = 107 - F \times X - C \times Y$	$H = 106 - 3 - F \times X - C \times Y$	$H = 106 - 2 - F \times X - C \times Y$
d) Marshalling SP – TO	$H = 105 - F \times X - C \times Y$	$H = 105 - 3 - F \times X - C \times Y$	$H = 105 - 2 - F \times X - C \times Y$

H = max. length of tertiary cable (m)

F = total length of marshalling cords, marshalling pairs, device connection and device connector cords (m)

C = length of collection point cable (m)

X = relation between the insertion loss of the flexible cable (dB/m) and the insertion loss of the tertiary cable (dB/m)

Y = relation between the insertion loss of the collection point cable (dB/m) and the insertion loss of the tertiary cable (dB/m)

At operating temperatures above +20°C, H should be reduced by 0.2% for each 1°C for shielded cables and 0.4% for each°C (+20°C to +40°C) and 0.6% for each 1°C (>+40°C to +60°C) for unshielded cables.



## OUR RECOMMENDATION FOR THE RIGHT DATA CABLE

- ▶ Shielded cable with the highest possible category: e.g. category 7<sub>A</sub>
- ▶ Large conduction cross-section (AWG 22)
- ▶ If required – special designs with a permissible operating temperature > 60°C

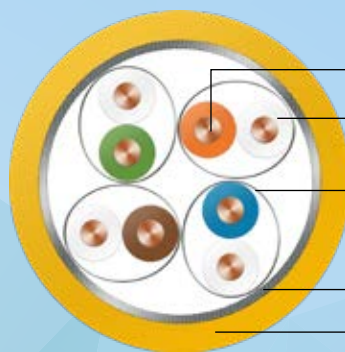

S/FTP data cable with AWG22/1 cross-section  
E.g. MegaLine® F10-130 S/F

<b>Conductor</b>	Bare copper wire, AWG 22/1
<b>Insulation Twisting element</b>	Foam PE, core Ø: Nominal value 1.6 mm Pair
<b>Individual shielding Twisting</b>	Aluminium-bonded polyester foil, metal on the outside (PIMF) 4 pairs
<b>Overall shielding</b>	Tinned copper wire braid
<b>Outer sheath</b>	Halogen-free, flame-retardant compound

## CONTACT BURN IN CONNECTORS

In connection technology, removing a plug under load can cause damage – so-called contact burn – due to the occurrence of an electric arc or sparking. An irreversible impairment of the contacts is caused, possibly even failure.

A potential remedy here is to use the appropriate port power management – i.e. first switch off the power supply, then remove the plug. However, intentional or unintentional disconnection of the plug under load cannot be entirely avoided.

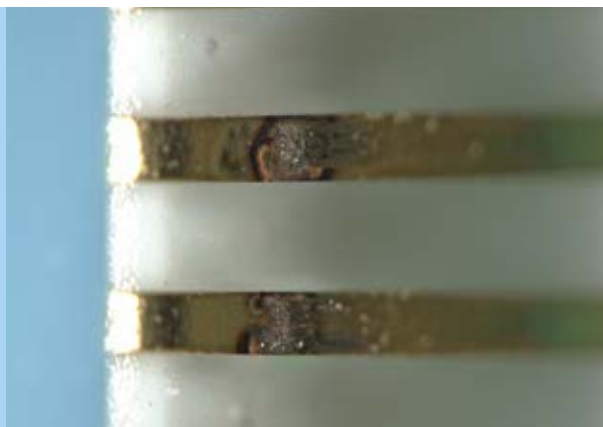

Contact burn in connection technology – shown here: a RJ45 socket (from IEC 62652)

Our recommendation for your choice of connection technology:

**Use staggered contact and insulation zones that exceed the relevant connector standards.**

## CERTIFIED SAFETY

**MegaLine® Connect100** and **MegaLine® Connect45 Pro**

With this in mind, KERPEN DATACOM has had the **MegaLine® Connect100** and **MegaLine® Connect45 Pro** product families independently tested in accordance with IEC 60512-99-001 and IEC 60512-9-3.

For this purpose, the socket/plug combinations were exposed to frequent insertion cycles under load. They easily adhered to the permitted deviation of transition resistances (max. 20 MΩ) with wide margins – **meaning their safety is certified.**



*MegaLine® Connect100 with staggered contact and insulation zones*

## SUMMARY AND OUTLOOK

Thanks to Power Ethernet, numerous IT devices are now able to do without a 230 V power supply. This technology enables buildings and offices to be planned and operated more intelligently and with greater energy efficiency.

### OUR CONTRIBUTION TO GREEN IT IN BUILDINGS.

Not least due to the planned increase in power levels, KERPEN DATACOM recommends using shielded data cables of category 7<sub>A</sub> with conductor dimension AWG 22 and connection technology with staggered contact and insulation zones.

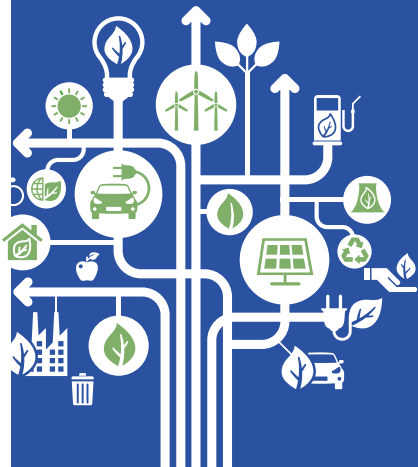

# FIRE-RESISTANT CABLES ACCORDING TO THE EU CONSTRUCTION PRODUCTS REGULATION

## MAXIMUM SAFETY WITH B2<sub>ca</sub> CABLES FROM KERPEN DATACOM

Fire provides warmth, light and a sense of security. Fire can also be life-threatening and cause extensive destruction in the event of a fire.



# SAFETY IN THE EVENT OF A FIRE

Where fires occur



One third of all fires occur in buildings. These result in numerous deaths due to gas and smoke poisoning.

The average length of time from the development of a fire until the rollover (pyrolysis gases) has decreased drastically in recent years.

- ▶ 1950: 15 minutes
- ▶ 1985: 5 minutes
- ▶ 2010: 3 minutes

As a result, the available time for a possible escape from the building has also been drastically reduced.

This situation has prompted construction material manufacturers to produce increasingly better and more flame-retardant products.

# FIRE SAFETY OF CABLE SYSTEMS

Save lives, impede fires, minimise consequential damage



Saving lives, impeding fires and minimising consequential damages are the priorities when fires break out. Electrical and optical cables must also play their part here, especially given the fact that cable density in modern buildings is constantly increasing. How can cables contribute to a positive behaviour in the event of a fire and/or what dangers are posed by obsolete, insufficiently fire-resistant cables? These questions can be assigned to three categories:

1. The cable must not significantly contribute to fire propagation. In particular, it must not propagate the fire from one storey to the next. It must also be ensured that there are no droplets and particles that contribute to fire propagation.

2. Smoke and toxic gases must be avoided as they hamper the safe evacuation of buildings and make it difficult or impossible for emergency services to intervene. Most cases of death in the event of a fire can be traced to smoke and toxic gases, not to the fire itself. Therefore, this aspect should actually be given top priority.

3. The rebuilding phase comes after the fire. This is complicated when large quantities of corrosive combustion gases have developed from the fire, because these gases build corrosive acids (e.g. hydrochloric acid) when combined with extinguishing water. Such acids are finely dispersed well beyond the location of the fire throughout the entire building, causing damage to all metallic objects.

Possible examples include: structural steel, metal constructions, electrical installations, electronics and IT systems.

SAVE LIVES

IMPEDE  
FIRES

MINIMISE CONSE-  
QUENTIAL DAMAGE

These three requirements have been incorporated into the fire classification of the new EU Construction Products Regulation.

# CE MARKING AND DECLARATION OF PERFORMANCE

## EU Construction Products Regulation

Power, control and communication cables that are permanently installed in structures fall under EU Regulation 305/2011 (Construction Products Regulation). Excluded from this: lift cables, cables inside machinery and cables for use in industrial plants.

The EU Construction Products Regulation defines the conditions for the CE marking and requires a declaration of performance of the manufacturer on the following essential product features derived from the protective goals: fire safety (flame propagation, heat development, smoke production, Acidity, flaming droplets) and the absence of harmful substances. The Construction Products Regulation also specifies how conformity with requirements is permanently ensured.

With the publication of the harmonised standard EN 50575:2014 in the Official Journal of the European Union, the obligation to implement the Construction Products Regulation has now been established for all market participants. This standard states the following: 'Power, control and communication cables, cables for general applications in construction works terms of fire behaviour requirements'. Effective 01 July 2016, cable manufacturers must provide a CE marking on their products that have been tested and certified by a notified body and issue a corresponding declaration of performance.

After the lapse of the coexistence period, which is one year, the CE marking and creation of a declaration of performance are mandatory.

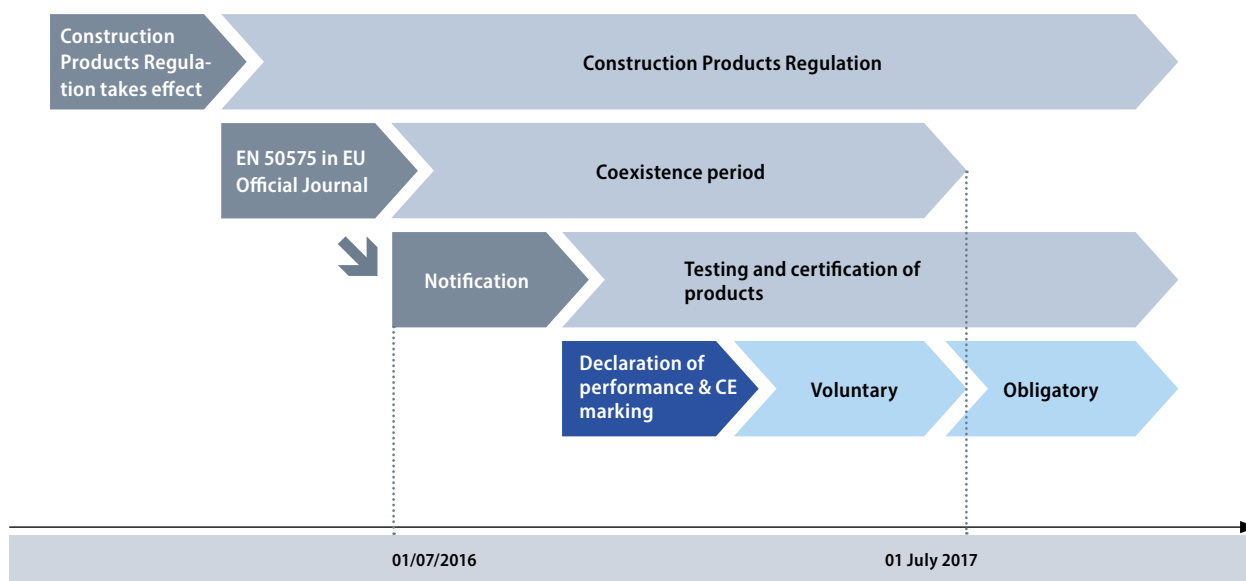

The declaration of performance certifies compliance with the fire classes defined below and is thus a requirement for use of the cable for the applications defined by the EU member states.

**Note:** Cables with insulation and total system integrity (resistance to fire) are handled separately in a different standard to be harmonised in the future. They are therefore not subject to current implementation of the Construction Products Regulation.

# FIRE CLASSIFICATIONS AND PROOF OF CONFORMITY

## EU Construction Products Regulation

The classes of fire behaviour are summarised in the following table that classifies the requirements from A<sub>ca</sub> (non-flammable) to B1<sub>ca</sub> or B2<sub>ca</sub> (very high) to C<sub>ca</sub> (high), D<sub>ca</sub> (moderate), E<sub>ca</sub> (low) and

F<sub>ca</sub> (no requirement).

This classification from A to F applies in general to all construction products. The index 'ca' stands for cable.

### Classes of fire behaviour of electrical cabins according to DIN EN 13501-6

Test procedure	Parameter	Classification						
		A <sub>ca</sub>	B1 <sub>ca</sub>	B2 <sub>ca</sub>	C <sub>ca</sub>	D <sub>ca</sub>	E <sub>ca</sub>	F <sub>ca</sub>
EN ISO 1716	PCS (MJ/kg)	≤ 2.0	–	–	–	–	–	–
EN 60332-1	H (mm)	–	≤ 425	≤ 425	≤ 425	≤ 425	≤ 425	–
EN 50399	Flame source (kW)	–	30	20.5	20.5	20.5	–	–
EN 50399	FS (m)	–	≤ 1.75	≤ 1.5	≤ 2.0	–	–	–
EN 50399	THR (MJ)	–	≤ 10	≤ 15	≤ 30	≤ 70	–	–
EN 50399	Max. HRR (kW)	–	≤ 20	≤ 30	≤ 60	≤ 400	–	–
EN 50399	FIGRA (W/s)	–	≤ 120	≤ 150	≤ 300	≤ 1300	–	–

Test procedure	Parameter	Additional classification						
		A <sub>ca</sub>	B1 <sub>ca</sub>	B2 <sub>ca</sub>	C <sub>ca</sub>	D <sub>ca</sub>	E <sub>ca</sub>	F <sub>ca</sub>
EN 50399/EN 61034	Smoke development	–	s1, s1a, s1b, s2, s3	s1, s1a, s1b, s2, s3	s1, s1a, s1b, s2, s3	s1, s1a, s1b, s2, s3	No	No
EN 60754-2	corrosiveness	–	a1, a2, a3	a1, a2, a3	a1, a2, a3	a1, a2, a3	No	No
EN 50399	Flaming droplets	–	d0, d1, d2	d0, d1, d2	d0, d1, d2	d0, d1, d2	No	No

**H:** Flame spread, vertical flame propagation (mm)

**FS:** Flame spread, vertical flame propagation (m)

**PCS:** Pouvoir Calorifique Supérieur, gross calorific value

**THR:** Total heat release (MJ)

**HRR:** Heat release rate, maximum heat release rate (kW)

**FIGRA:** Fire growth rate, index of heat release rate (W/s)

**TSP:** Total smoke production,

Total smoke generation (m<sup>2</sup>)

**SPR:** Smoke production rate, max. smoke production rate, maximum value of smoke production (m<sup>2</sup>/s)

### Explanation

**s1** = TSP ≤ 50 m<sup>2</sup> and max. SPR ≤ 0.25 m<sup>2</sup>/s

**s1a** = **s1** and transmission value according to EN 61034-2 ≥ 80%

**s1b** = **s1** and transmission value according to EN 61034-2 ≥ 60% < 80%

**s2** = TSP ≤ 400 m<sup>2</sup> and max. SPR ≤ 1.5 m<sup>2</sup>/s

**s3** = neither s1 nor s2

**d0** = no flaming droplets/particles

**d1** = no flaming droplets/particles for longer than 10 s

**d2** = neither d0 nor d1

EN 60754-2:

**a1** = electrical conductivity < 2.5 μS/mm and pH value > 4.3

**a2** = electrical conductivity < 10 μS/mm and pH value > 4.3

**a3** = neither a1 nor a2. No data = no performance determined.

Conformity monitoring is also set out in detail in the Construction Products Regulation and defined by EN 50575.

The following is a simplified summary of the obligations for the notified approval body and the manufacturer:

Class of fire behaviour	A <sub>ca</sub>	B1 <sub>ca</sub>	B2 <sub>ca</sub>	C <sub>ca</sub>	D <sub>ca</sub>	E <sub>ca</sub>	F <sub>ca</sub>
System of conformity monitoring	1+				3		4
Obligations of the notified body	Sample testing and recurring factory auditing with random sampling				Sample testing		–
Obligations of the manufacturer	Production monitoring				Production monitoring		–

## OVERVIEW OF FIRE TESTS

These are the goals when using safety cables.

1. ►► SAVE LIVES
2. ►► IMPEDE FIRES
3. ►► MINIMISE CONSEQUENTIAL DAMAGE

**The fire test according to EN 50399 covers goals 1 and 2.**

Because reduced fire propagation, smoke and flaming droplets make an essential contribution to fire safety.

The cables (number used dependent on cable diameter) are mounted onto a ladder in a vertical tube furnace and a flame is applied to them for 20 minutes using an air gas burner (20.5 kW/30 kW). The flue gases are collected with a defined air current (nominal value 8000 l/min) and conducted into an exhaust air duct in which the speed of the air current, the oxygen and CO<sub>2</sub> content, the light absorption and the temperature are measured. This allows the above values to be determined. As many parameters differ from those occurring in the test according to IEC 60332-3, the results cannot be transferred. In particular, the installation of the cable with the distance and elevated air current make the fire scenario more demanding than in IEC 60332-3.

The test according to EN 50399 clearly demonstrates the difference between a cable with high fire safety (below) and a cable of lower quality. Fire propagation, smoke generation and flaming droplets (top) are observed.

### Fire classes according to the Construction Products Regulation

Cables for power, control and communication technology for fixed installation in buildings are analysed and classified with respect to their fire behaviour according to EU Regulation 305/2011. For this purpose, heat release and flame spread are measured using the above test method according to EN 50399 and evaluated to classify the cables according to the relevant fire class. The cables can also achieve additional classification according to the Construction Products Regulation if their smoke production, flaming droplets and acidity levels are determined.

**The test according to EN 50399 determines flame propagation, heat release, smoke generation and flaming droplets/particles.**



EN 50399

*The majority of the parameters required for cables in the Construction Products Regulation are determined by testing in line with EN 50399.*

*A strongly burning cable with increased smoke and flaming droplets/particles.*



EN 50399

*A cable that fulfils requirements B2<sub>o</sub>s1 d1 a1.*

*Smoke production in test conditions according to EN 61034:  
This fire test was carried out on a heavily smoking cable.*



EN 61034

*Smoke production in test conditions according to EN 61034:  
This fire test was carried out on a cable that meets the requirements.*



EN 61034

*Flame test on individual cable according to EN 60332-1, the basic requirement.*



EN 60332-1

**Smoke generation is subject to especially strict evaluation in the test according to EN 61034.**

Reduced smoke generation is a key feature for achieving goal 1 for the evacuation of buildings with a high density of occupants and difficult evacuation conditions. The evaluation of corrosivity and/or acidity (EN 50267) is important for avoiding consequential damages due to corrosion (goal 3) and especially for avoiding toxic effects on people (goal 2) who are trying to escape from the fire to safety.

**The flame test on an individual cable according to EN 60332-1 forms the basis for less-demanding requirements.**

These objectives are implemented by the Construction Products Regulation in that the safety levels defined by the fire tests are applied in relation to the building in question. The German Electrical and Electronic Manufacturers' Association (ZVEI) has drafted a proposal for the effective application of these safety levels. This is presented below and on the following pages.

Depending on the safety requirement in buildings, the ZVEI recommends the use of fire-resistant cables. Using Class B<sub>2ca</sub> cables is beneficial in buildings with very high safety requirements. Using cables in line with Class C<sub>ca</sub> is beneficial in buildings with high safety requirements. A recommendation for the building classification according to the German Model Building Code (MBO) was also drafted on this basis. These recommendations are incorporated into the new versions of the construction regulations for communication and energy systems. (DIN EN 50174 part 1-3, DIN VDE 0100-520 and DIN VDE 0100-420).

# CABLE TYPES WITH EUROCLASS B<sub>2ca</sub> s1a d1 a1

## Overview of the areas of application

### Recommendation of the ZVEI for the fire classes to be applied for cable under the Construction Products Regulation

Fire classes				Safety requirement in the building
Flame propagation Heat development	Smoke production/density	Flaming droplets	Acid production/corrosivity	
A <sub>ca</sub>	–	–	–	Very high
B1 <sub>ca</sub>	–	–	–	Very high
B2 <sub>ca</sub>	s1	d1	a1	Very high
C <sub>ca</sub>	s1	d1	a1	High
D <sub>ca</sub>	s2	d2	a1	Moderate
E <sub>ca</sub>	–	–	–	Low
F <sub>ca</sub>	–	–	–	None

### Proposal of the ZVEI for building classification

Building classes according to the German Model Building Code				ZVEI proposal	
Class	Description			Minimum requirement	
				Building (except for escape route)	Escape route
1	Isolated buildings and isolated agricultural or forestry buildings	Up to 7 m high	no more than 400 m <sup>2</sup>	E <sub>ca</sub>	–
2	Building	Up to 7 m high	no more than 400 m <sup>2</sup>	E <sub>ca</sub>	–
3	Other buildings	Up to 7 m high	–	E <sub>ca</sub>	B2 <sub>ca</sub> s1 d1 a1
4	Other buildings	Up to 13 m high	Up to n × 400 m <sup>2</sup>	E <sub>ca</sub>	B2 <sub>ca</sub> s1 d1 a1
5	Other buildings including underground buildings	–	–	C <sub>ca</sub> s1 d2 a1	B2 <sub>ca</sub> s1 d1 a1

Special structures				ZVEI proposal	
S1	High-rise buildings	Higher than 22 m		C <sub>ca</sub> s1 d2 a1	B2 <sub>ca</sub> s1 d1 a1
S2	Construction systems	Higher than 30 m		C <sub>ca</sub> s1 d2 a1	B2 <sub>ca</sub> s1 d1 a1
S3	Building	More than 1600 m <sup>2</sup> largest storey, excluding residential buildings and garages		C <sub>ca</sub> s1 d2 a1	B2 <sub>ca</sub> s1 d1 a1
S4	Retail buildings	Larger than 800 m <sup>2</sup>		C <sub>ca</sub> s1 d2 a1	B2 <sub>ca</sub> s1 d1 a1
S5	Office/administration	Rooms larger than 400 m <sup>2</sup>		C <sub>ca</sub> s1 d2 a1	B2 <sub>ca</sub> s1 d1 a1
S6	Building with rooms	Individual rooms for use by more than 100 persons		C <sub>ca</sub> s1 d2 a1	B2 <sub>ca</sub> s1 d1 a1
S7	Assembly buildings	More than 200 persons		C <sub>ca</sub> s1 d2 a1	B2 <sub>ca</sub> s1 d1 a1
S8	Restaurants/hotels	Buildings with an occupancy of more than 40 guests, more than 12 beds, amusement halls larger than 150 m <sup>2</sup>		C <sub>ca</sub> s1 d2 a1	B2 <sub>ca</sub> s1 d1 a1
S9	Buildings with units for people in need of care or assistance	More than 6 persons, intensive care requirement		B2 <sub>ca</sub> s1 d1 a1	B2 <sub>ca</sub> s1 d1 a1
S10	Hospitals			B2 <sub>ca</sub> s1 d1 a1	B2 <sub>ca</sub> s1 d1 a1
S11	Other facilities for accommodation of persons and residential homes			C <sub>ca</sub> s1 d2 a1	B2 <sub>ca</sub> s1 d1 a1
S12	Day care facilities for children, disabled and elderly persons			B2 <sub>ca</sub> s1 d1 a1	B2 <sub>ca</sub> s1 d1 a1
S13	Schools, universities and similar facilities			C <sub>ca</sub> s1 d2 a1	B2 <sub>ca</sub> s1 d1 a1
S14	Correctional facilities / involuntary treatment			C <sub>ca</sub> s1 d2 a1	B2 <sub>ca</sub> s1 d1 a1
S16	Leisure / amusement parks			C <sub>ca</sub> s1 d2 a1	B2 <sub>ca</sub> s1 d1 a1
S18	Warehouse with top edge of loaded goods higher than 7.5 m			E <sub>ca</sub>	B2 <sub>ca</sub> s1 d1 a1
S19	Construction systems for storage of materials with an elevated risk of fire			B2 <sub>ca</sub> s1 d1 a1	B2 <sub>ca</sub> s1 d1 a1

Additional specified structures		ZVEI proposal	
Manufacturing		C <sub>ca</sub> s1 d2 a1	B2 <sub>ca</sub> s1 d1 a1
Server rooms		B2 <sub>ca</sub> s1 d1 a1	B2 <sub>ca</sub> s1 d1 a1
Road tunnels		B2 <sub>ca</sub> s1 d1 a1	B2 <sub>ca</sub> s1 d1 a1
Railway tunnels		B2 <sub>ca</sub> s1 d1 a1	B2 <sub>ca</sub> s1 d1 a1
Underground garages		C <sub>ca</sub> s1 d2 a1	B2 <sub>ca</sub> s1 d1 a1

# ON THE SAFE SIDE WITH KERPEN DATACOM

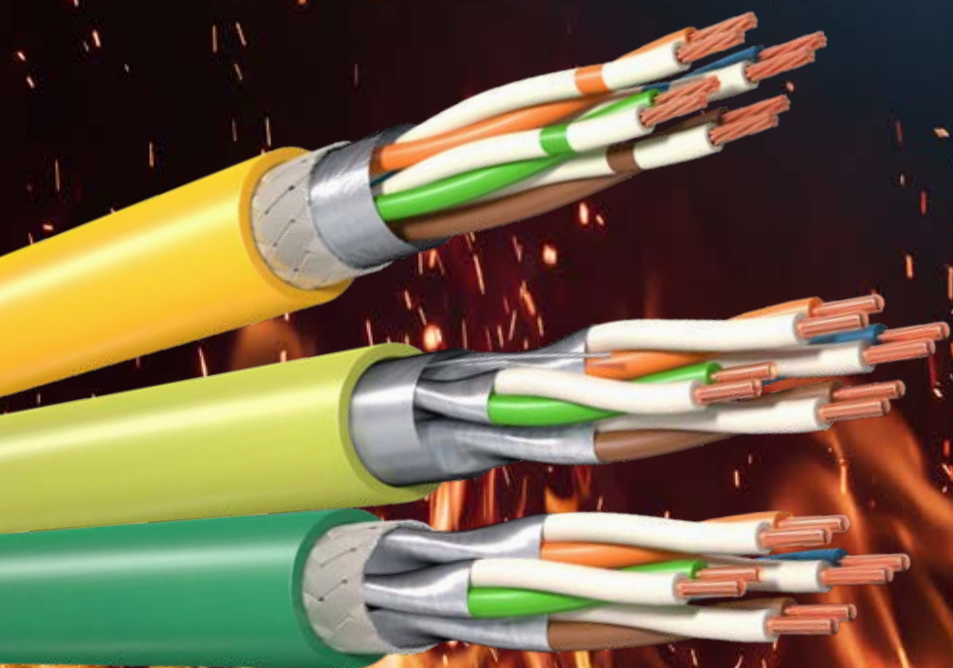

KERPEN DATACOM currently offers the best fire protection cable technology available.



## DATA CABLES COLOUR CODED BY CPR CLASSES

Increased safety for logistics, installation and building approval due to colour distinctions

In addition to standard cables corresponding to the new fire classes  $D_{ca}$  or  $E_{ca}$ , the company can also provide fire class  $B2_{ca}$  cables. Euro-class  $B2_{ca}$  s1 d1 a1 fire protection cable offers the highest safety with:

- ▶ **Reduced fire propagation**
- ▶ **Reduced heat development**
- ▶ **Low smoke generation**
- ▶ **Low acid production**
- ▶ **Reduced droplet formation**

The quality of these cable products is assured by:

- ▶ **Conformity verification 1+**
- ▶ **Declaration of Performance**
- ▶ **CE mark**

KERPEN DATACOM **MegaLine®** data cables are colour-coded by CPR class for easy and safe installation in buildings with varying fire requirements.

As well as increasing safety, this colour scheme benefits logistics technicians and fitters.

**Cable of CPR Class  $D_{ca}$  in colza yellow**

**Cable of CPR Class  $C_{ca}$  in lime green**

**Cable of CPR Class  $B2_{ca}$  in yellow-green**

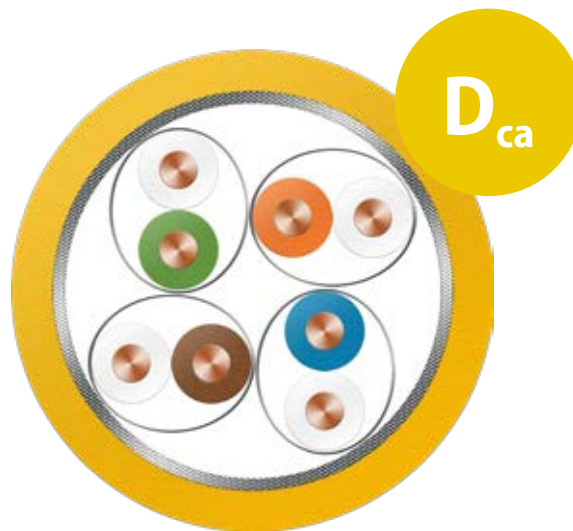

Cable sheath in **colza yellow**



Cable sheath in **lime green**

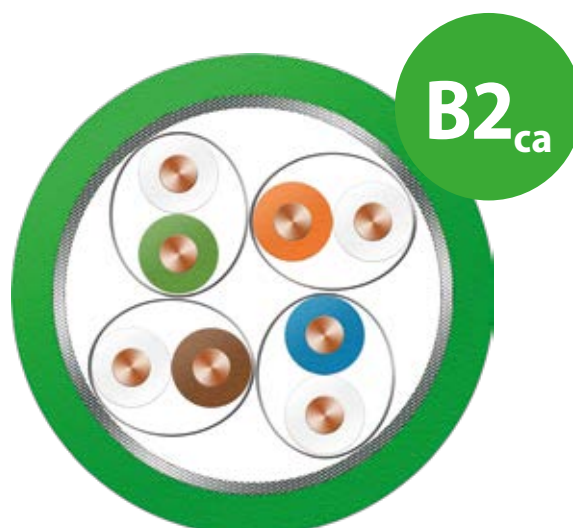

Cable sheath in **yellow -green**

## TYPE CODES

### MegaLine® copper data cables

		MegaLine® F10-130 S/F H			
<b>Cabling class</b>					
Class 7 <sub>A</sub> +	<b>G</b>				
Class F	<b>F</b>				
Class E	<b>E</b>				
Class D	<b>D</b>				
<b>Bandwidth in line with standard (factor 100)</b>					
2000 MHz	<b>20</b>				
1200 MHz	<b>12</b>				
1000 MHz	<b>10</b>				
600 MHz	<b>6</b>				
500 MHz	<b>5</b>				
250 MHz	<b>2</b>				
100 MHz	<b>1</b>				
<b>MegaLine® bandwidth (factor 10)</b>					
1500 MHz	<b>150</b>				
1300 MHz	<b>130</b>				
1150 MHz	<b>115</b>				
900 MHz	<b>90</b>				
800 MHz	<b>80</b>				
700 MHz	<b>70</b>				
450 MHz	<b>45</b>				
300 MHz	<b>30</b>				
200 MHz	<b>20</b>				
<b>TP (twisted pair) design</b>					
Overall shielding (copper braiding)/individual shield (foil)	<b>S/F</b>				
Overall shielding (foil)/individual shielding (foil)	<b>F/F</b>				
Unshielded/individual shielding (foil)	<b>U/F</b>				
Overall shielding (copper braiding & foil)/unshielded	<b>SF/U</b>				
Overall shielding (foil)/unshielded	<b>F/U</b>				
Unshielded/unshielded	<b>U/U</b>				
<b>Sheath/armouring</b>					
Halogen free, flame-retardant	<b>H</b>				
PVC	<b>Y</b>				
PE	<b>2Y</b>				
PUR	<b>11Y</b>				
Sheath	<b>(L)2Y</b>				
Reinforced sheath for industrial applications	<b>V</b>				
Oil-resistant	<b>Ö</b>				
Steel wire braiding	<b>Q</b>				

The type codes for **MegaLine®** copper data cables are compatible with the SPACE concept. This makes it easier to assign cables to the old and new cabling classes and the corresponding categories.

#### The type codes also provide:

- ▶ Specifications for the bandwidth in comparison with the standard
- ▶ Specifications for the design according to international standard
- ▶ Specifications for the sheath material used

#### Copper data cables: **MegaLine® F10-130 S/F H**

- F** according to cabling Class/Category F<sub>A</sub> (1000 MHz)
- 10** Bandwidth according to standard: 1000 MHz
- 130** **MegaLine®** bandwidth: 1300 MHz
- S/F** In S/FTP design
- H** **With halogen-free outer sheath**

# CABLE TYPES AND MATERIALS

## MegaLine® copper data cables

Cable sheath material

Material characteristics	FRNC	PUR	PVC	PE
Resistance to ageing	+	+	+	+
Halogen content	+	+	--	+
Flame resistance	+	●	+	--/●
Elasticity	-	+	●	-
Abrasion resistance	-	++	+	+/-
Low smoke gas generation	++	●	-	--/●
Low emission of corrosive gases	++	●	--	+/●
Low smoke gas toxicity	++	●	--	+/●
Toxicological safety	++	●	-	+/●

- ++ Excellent
- + Good
- Depends on recipe
- Poor
- Unsatisfactory

Cable sheath material

Gen. resistance to	FRNC	PUR	PVC	PE
UV light	1)	1)	1)	1)
Water absorption	-	-	+	+
Gas diffusion	-	2)	-	●
Fuels	-	+	+/-	+
Petroleum/lubricants	-	++	●	+
Organic solvents	-	+ 3)	-	+ 4)
Alcohol	-	-	+	+
Oxidants	-	-	+	-
Acids	+	--	+	++
Alkaline solutions	+	--	+	+
Saline solutions	+	-	+	+

- 1) Increased resistance due to the addition of black pigments/UV stabilisers
- 2) Permeation depending on type of gas e.g. Ar, CH<sub>4</sub>, N<sub>2</sub>, O<sub>2</sub> – low gas permeation, CO<sub>2</sub>, H<sub>2</sub>, He – higher gas permeation
- 3) Low swelling in saturated hydrocarbons; significant swelling in aromatic hydrocarbons. Aliphatic esters cause swelling, high polarity organic solvents dissolve under the effect of extreme swelling
- 4) Swelling in aliphatic and aromatic hydrocarbons and chlorinated hydrocarbons

### Cable type xx/xxx

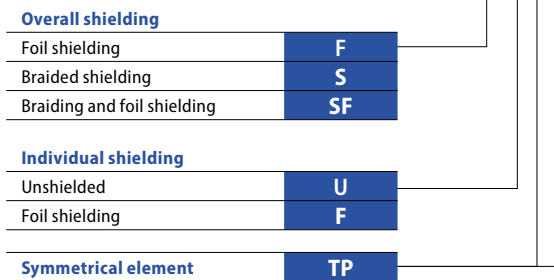

S/FTP (PiMF with overall shield-)

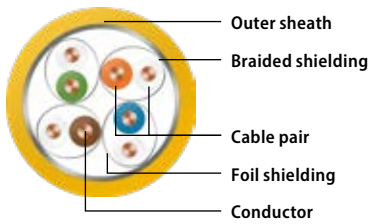

F/FTP

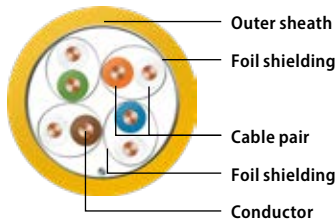

U/FTP

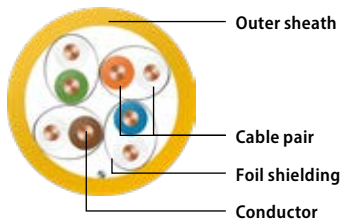

SF/UTP

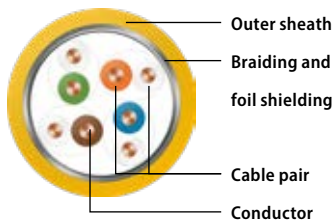

F/UTP

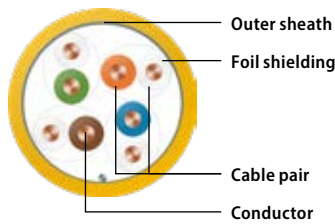

U/UTP

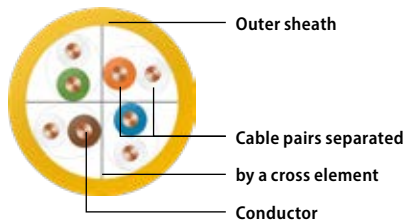

The relevant ISO/IEC specifies standardisation that clearly defines the design elements.

# MegaLine® G20 S/F

Category 8.2



Types KS-02YSCH 4x2x0.62 mm/~AWG 22/1 PIMF  
KS-02YSCH 2x(4x2x0.62 mm/~AWG 22/1 PIMF)

## Benefits

- ▶ Data centre cabling
- ▶ Better than Cat. 8.2
- ▶ Bandwidth 2000 MHz
- ▶ Excellent shielding characteristics
- ▶ PVP-GHMT
- ▶ RoHS and REACH conformity

## Construction for 4P

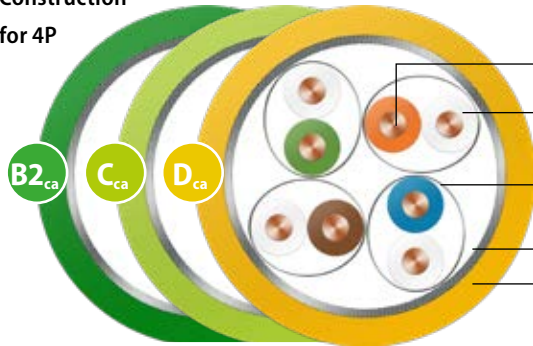

<b>Conductor</b>	Bare copper wire, 0.62 mm/~AWG 22/1
<b>Insulation</b>	Foam PE, core Ø: Nominal value 1.6 mm
<b>Twisting element</b>	Pair
<b>Individual shielding</b>	Aluminium-bonded polyester foil, metal on the outside (PIMF)
<b>Twisting</b>	4 pairs
<b>Overall shielding</b>	Tinned copper wire braid
<b>Outer sheath</b>	halogen-free, flame-retardant compound

<b>Fire behaviour</b>	
Flame retardancy	according to IEC 60332-3-24
Halogen free	according to IEC 60754-1/2
Smoke density	according to IEC 61034-1/2
Acidity	according to EN 60754-2
Fire load (reference value)	0.74 MJ/m
EU Construction Products Regulation	according to EN 50575 / EN 50399

<b>Performance</b>	
Better than Category 8.2 according to IEC 61156-9, excellent NEXT, very low attenuation, excellent shielding characteristics (pairs and overall shielding), low skew. Bandwidth (typical): 2000 MHz	

<b>Applications</b>	
Installation cable for use in structured cabling according to ISO/IEC 11801 and EN 50173 (3rd edition) and data centre cabling in accordance with TR 11801-9901, 11801-99-1.	
Ideal for all applications of Classes D to F <sub>x</sub> and Class II, multimedia (TV, video, data, voice) >40 GbE according to IEEE 802.3bq, cable sharing, VoIP, PoE/PoE+/4PPoE	

<b>Mechanical characteristics</b>	
Bending radius	During installation 8 x outer diameter (min.) After installation 4 x outer diameter (min.)
Tensile strength (max.)	130 N
Crush strength	1000 N/100 mm
Impact strength (number of shocks)	10

<b>Electromagnetic behaviour</b>	
Coupling resistance at 10 MHz (nom.)	2 mΩ/m
Screen attenuation (nom.)	80 dB
Coupling attenuation (nom.)	90 dB
Separating class according to EN 50174-2	d

## Security (fire behaviour)

<b>S</b>	1 IEC 60332-2-2	2 IEC-60332-1-2 E <sub>ca</sub> /D <sub>ca</sub>	3 IEC-60332-3-24 E <sub>ca</sub> /D <sub>ca</sub>	4 EFP Grade 1 C <sub>ca</sub>	5 EFP Grade 2 B2 <sub>ca</sub>
----------	--------------------	--	---	-------------------------------------	--------------------------------------

## Performance (cabling class, bandwidth)

<b>P</b>	1 > Class E > 250 MHz	2 > Class E <sub>x</sub> > 500 MHz	3 > Class F > 600 MHz	4 > Class F <sub>x</sub> > 1000 MHz	5 > Class F <sub>x</sub> + > 1200 MHz
----------	-----------------------------	--	-----------------------------	---	---

## Application (Ethernet, TV)

<b>A</b>	1 > 100 MbE	2 > 1 GbE	3 Up to 10 GbE	4 > 10 GbE	5 > 10 GbE TV
----------	----------------	--------------	-------------------	---------------	------------------

## Construction (conductor dimension, tensile strength)

<b>C</b>	1 AWG 27	2 AWG 26/25	3 AWG 24	4 AWG 23	5 AWG 22
----------	-------------	----------------	-------------	-------------	-------------

## EMC (coupling attenuation)

<b>E</b>	1 > 40 dB	2 > 50 dB	3 > 60 dB	4 > 70 dB	5 > 80 dB
----------	--------------	--------------	--------------	--------------	--------------

## Electrical characteristics (HF) at 20°C

Frequency MHz	Attenuation dB/50 m		NEXT dB		PS-NEXT dB		ACR dB at 50 m		PS-ACR dB at 50 m		EL-FEXT dB at 50 m		PS-ELFEXT dB at 50 m		RL dB	
	Typ.	Cat. 8.2 max.*	Typ.	Cat. 8.2 min.*	Typ.	Cat. 8.2 min.*	Typ.	Cat. 8.2 min.*	Typ.	Cat. 8.2 min.*	Typ.	Cat. 8.2 min.*	Typ.	Cat. 8.2 min.*	Typ.	Cat. 8.2 min.*
10	2.4	2.9	100	78	97	75	97.6	75.1	94.6	72.1	90	78	87	75	32.3	25
100	8.6	9.3	100	75.4	97	72.4	91.4	66.1	88.4	63.1	90	60.6	87	57.6	36.2	22.5
250	13.7	14.7	100	69.5	97	66.5	86.3	54.8	83.3	51.8	84	52.6	81	49.6	34.8	20.1
500	18.9	21.4	100	64.9	97	61.9	81.1	43.5	78.1	40.5	79	46.6	76	43.6	31.8	17.3
600	22	23.6	100	63.7	97	60.7	78	40.2	75	37.2	78	45	75	42	28.5	17.3
800	25.6	27.5	95	61.9	92	58.9	69.4	34.4	66.4	31.4	71	42.5	68	39.5	25.3	16.1
1000	28.9	31	92	60.4	89	57.4	63.1	29.4	60.1	26.4	62	40.6	59	37.6	22.2	15.2
1200	31.6	34.2	88	59.2	85	56.2	56.4	25	53.4	22	60	39	57	36	20.2	14.7
1500	35.2	38.6	77	57.8	74	54.8	40.8	19.2	37.8	16.2	53	37.1	50	34.1	19.2	14
1600	36.6	40	75	57.3	72	54.3	37.8	17.3	34.8	14.3	50	36.5	47	33.5	18.4	13.8
1700	38.1	41.4	75	56.9	72	53.9	36.9	15.5	33.9	12.5	45	36	42	33	17.1	13.6
1800	39.5	42.7	75	56.6	72	53.6	35.5	13.9	32.5	10.9	42	35.5	39	32.5	16.3	13.4
1900	41.1	44	75	56.2	71	53.2	33.9	12.2	30.9	9.2	40	35	37	32	15.6	13.3
2000	43.5	45.3	75	55.9	72	52.9	31.5	10.7	28.5	7.7	40	34.6	37	31.6	15.1	13.1

\* IEC 61156-9 (2016) If IO-FEXT is min. 90 dB to 1000 MHz and min. 80 dB to 2000 MHz, EL-FEXT is fulfilled by design.

## Electrical characteristics at 20°C

Direct current resistance	Max.	68 Ω/km
Insulation resistance	Min.	5 GΩ x km
Mutual capacitance	Approx.	43 pF/m
Capacitive coupling (e)	Approx.	1000 pF/km
Signal tempo (c)	Approx.	0.76
Propagation delay	Approx.	440 ns/100 m
Skew at 100 MHz	Approx.	12 ns/100 m
Charact. impedance	at 100 MHz	100 ± 5 Ω
Testing voltage U <sub>eff</sub>		1000 V
Operating voltage	Max.	125 V

## Thermal properties

For fixed installation	-20 °C up to +60 °C
For mobile operation	0°C up to +50°C

## Chemical characteristics

Free of hazardous substances according to RoHS 2011/65/EU

## Cable printing

KERPEN DATACOM GmbH Made in Germany **MegaLine®** G20 S/F  
4P H 25G 4PPoE "CPR Class" "DoP no." "Batch number" "Metre  
marking"

## Certificates and approvals

Quality mark with production control: GHMT PVP  
Link performance: KERPEN DATACOM **MegaLine®** systems and  
other commercially available connector systems  
Test certificates: according to DIN 55350-18-4.2.1 or EN 10204  
Compliant with LVD (2014/35/EU): **CE**  
Compliant with Construction Products Regulation  
(EU/305/2011): **CE**

Dimensions	Outer Ø approx.	Weight approx.	Copper sales factor*	CPR Class	DoP no.	Sheath colour	Order no.
	mm	kg/km	kg/km				
4P	8.4	68	44	D <sub>ca</sub> s2 d2 a1	CDESK0000007	◆ Colza yellow	LKD7KS80020xxxx
2 x 4P	8.4 x 17.5	162	90	D <sub>ca</sub> s2 d2 a1	CDESK0000008	◆ Colza yellow	LKD7KS80022xxxx
4P	8.4	68	44	C <sub>ca</sub> s1 d1 a1	CDESK0000034	◆ Lime green	LKD7KS8C020xxxx
4P	8.4	68	44	B2 <sub>ca</sub> s1a d1 a1	CDESK0000010	◆ Yellow green	LKD7KS8B020xxxx

Packaging: xxxx

Standard length: 0100 = 1000 m 0050 = 500 m 0000 = general

\* See page 17: Definition of copper sales factor

# MegaLine® G20 S/F Mini

## Category 8.2



Type KS-02YSCH 4x2xAWG26/1 PIMF

### Benefits

- ▶ Better than Cat. 8.2
- ▶ Data centre cabling
- ▶ Bandwidth 2000 MHz
- ▶ Excellent shielding characteristics
- ▶ RoHS and REACH conformity

### Construction for 4P

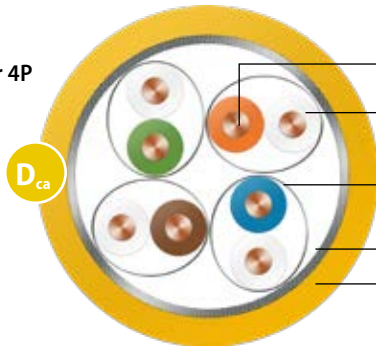

<b>Conductor</b>	Bare copper wire, AWG 26/1
<b>Insulation</b>	Cellular PE, core-diameter: max. 1.05 mm
<b>Twisting element</b>	Pair
<b>Individual shielding</b>	Aluminium-bonded polyester foil, metal on the outside (PiMF)
<b>Twisting</b>	4 pairs
<b>Overall shielding</b>	Tinned copper wire braid
<b>Outer sheath</b>	halogen-free, flame-retardant compound

### Fire behaviour

Flame retardancy	according to IEC 60332-1-2
Halogen free	according to IEC 60754-1/2
Smoke density	according to IEC 61034-1/2
Fire load (reference value)	0.38 MJ/m
EU Construction Products Regulation	according to EN 50575 / EN 50399

### Performance

Better than Cat. 8.2 according to IEC 61156-10, excellent NEXT, very low attenuation, excellent shielding characteristics (pairs and overall shielding), low skew, bandwidth (typical): 2000 MHz

### Applications

Connection cables and patch cords for use in structured building cabling according to ISO/IEC 11801 and EN 50173 (3rd edition) and data centre cabling in accordance with TR 11801-9901.

Ideal for all applications of Classes D to F<sub>x</sub> and Class II, multimedia (TV, video, data, voice) 25/40 GbE according to IEEE 802.3bq, cable sharing, VoIP, PoE/PoE+/4PPoE

### Mechanical characteristics

Bending radius	During installation	8 x outer diameter (min.)
	After installation	4 x outer diameter (min.)
Tensile strength (max.)		60 N

### Electromagnetic behaviour

Coupling resistance at 10 MHz (nom.)	5 mΩ/m
Screen attenuation (nom.)	60 dB
Coupling damping (nom.)	85 dB
Separation class according to EN 50174-2	d

### Security (fire behaviour)

S	1	2	3	4	5
	IEC 60332-2-2	IEC-60332-1-2	IEC-60332-3-24	EFP Grade 1	EFP Grade 2
		E <sub>ca</sub> /D <sub>ca</sub>	E <sub>ca</sub> /D <sub>ca</sub>	C <sub>ca</sub>	B2 <sub>ca</sub>

### Performance (cabling class, bandwidth)

P	1	2	3	4	5
	> Class E > 250 MHz	> Class E <sub>x</sub> > 500 MHz	> Class F > 600 MHz	> Class F <sub>x</sub> > 1000 MHz	> Class F <sub>x</sub> + > 1200 MHz

### Application (Ethernet, TV)

A	1	2	3	4	5
	> 100 MbE	> 1 GbE	Up to 10 GbE	> 10 GbE	> 10 GbE TV

### Construction (conductor dimension, tensile strength)

C	1	2	3	4	5
	AWG 27	AWG 26/25	AWG 24	AWG 23	AWG 22

### EMC (coupling attenuation)

E	1	2	3	4	5
	> 40 dB	> 50 dB	> 60 dB	> 70 dB	> 80 dB

### Electrical characteristics (HF) at 20°C

Frequency MHz	Attenuation dB/30 m		NEXT dB		PS-NEXT dB		ACR dB at 30 m		PS-ACR dB at 30 m		EL-FEXT dB at 30 m		PS-ELFEXT dB at 30 m		RL dB	
	Typ.	Cat. 8.2 max.*	Typ.	Cat. 8.2 min.*	Typ.	Cat. 8.2 min.*	Typ.	Cat. 8.2 min.*	Typ.	Cat. 8.2 min.*	Typ.	Cat. 8.2 min.*	Typ.	Cat. 8.2 min.*	Typ.	Cat. 8.2 min.*
10	1.8	2.6	100	90.4	97	87.4	98.2	87.8	95.2	84.8	120	80.8	117	77.8	26	25.0
100	6.6	8.3	100	75.4	97	72.4	93.4	67.1	90.4	64.1	106	60.8	103	57.8	30	22.2
250	10.6	13.4	100	69.4	97	66.4	89.4	56.1	86.4	53.1	102	52.8	99	49.8	29	19.4
500	15.5	19.2	95	64.9	92	61.9	79.5	45.7	76.5	42.7	92	46.8	89	43.8	28	17.3
600	16.9	21.2	93	63.7	90	60.7	76.2	42.5	73.2	39.5	89	45.2	86	42.2	25	16.8
1000	22.4	27.9	75	60.4	72	57.4	52.3	32.5	49.3	29.5	82	40.8	79	37.8	23	15.2
1200	24.2	30.8	72	59.2	69	56.2	47.7	28.4	44.7	25.4	80	39.2	77	36.2	22	14.7
1500	27.0	34.7	72	57.8	69	54.8	44.6	23.0	41.6	20.0	76	37.3	73	34.3	21	14.0
1600	28.2	36.0	72	57.3	69	54.3	43.4	21.3	40.4	18.3	74	36.7	71	33.7	21	13.8
1700	29.6	37.2	72	56.9	69	53.9	42.0	19.7	39.0	16.7	73	36.2	70	33.2	20	13.6
1800	30.2	38.4	64	56.6	61	53.6	33.6	18.2	30.6	15.2	72	35.7	69	32.7	20	13.4
1900	31.4	39.6	64	56.2	61	53.2	32.4	16.6	29.4	13.6	70	35.2	67	32.2	19	13.3
2000	32.5	40.7	62	55.9	59	52.9	29.5	15.2	26.5	12.2	68	34.8	65	31.8	14	13.1

\* IEC 61156-10 (2016 draft). If IO-FEXT is min. 90 dB to 1000 MHz and min. 80 dB to 2000 MHz, EL-FEXT is fulfilled by design.

### Electrical characteristics at 20°C

Direct current resistance	Max.	145 Ω/km
Insulation resistance	Min.	5 GΩ x km
Mutual capacitance	Approx.	49 pF/m
Signal tempo (c)	Approx.	0.78
Propagation delay	Approx.	490 ns/100 m
Skew at 100 MHz	Approx.	5 ns/100 m
Charact. impedance	at 100 MHz	100 ± 5 Ω
Testing voltage U <sub>eff</sub>		1000 V
Operating voltage	Max.	125 V

### Thermal properties

For fixed installation	-20 °C up to +60 °C
For mobile operation	0°C up to +50°C

### Chemical characteristics

Free of hazardous substances according to RoHS 2011/65/EU

### Cable printing

KERPEN DATACOM Made in Germany **MegaLine®** G20 S/F Mini 4P H 25G 4PPoE "CPR Class" "DoP no." "Batch number" "Metre marking"

### Certificates and approvals

Link performance: KERPEN DATACOM **MegaLine®** systems and other commercially available connector systems  
 Test certificates: according to DIN 55350-18-4.2.1 or EN 10204  
 Compliant with LVD (2014/35/EU): **CE**  
 Compliant with Construction Products Regulation (EU/305/2011): **CE**

Dimensions	Outer Ø approx.	Weight approx.	Copper sales factor*	CPR Class	DoP no.	Sheath colour	Order no.
	mm	kg/km	kg/km				
4P	6.0	40	23.5	D <sub>ca</sub> s2 d2 a1	CDESK0000030	◆ Colza yellow	LKD7KS80023xxxx

Packaging: xxxx

Standard length: 0100 = 1000 m 0050 = 500 m 0000 = general

\* See page 17: Definition of copper sales factor

# MegaLine® G12-150 S/F

## Category 7<sub>A</sub>



Types KS-02YSCH 4x2xAWG 22/1 PIMF  
KS-02YSCH 2x(4x2xAWG 22/1 PIMF)

### Benefits

- ▶ Better than category 7<sub>A</sub>
- ▶ Bandwidth 1500 MHz
- ▶ Excellent shielding characteristics
- ▶ PVP-GHMT
- ▶ RoHS and REACH conformity

### Construction for 4P

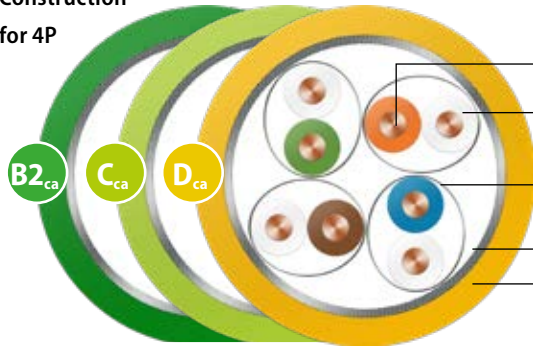

<b>Conductor</b>	Bare copper wire, AWG 22/1
<b>Insulation</b>	Foam PE, core Ø: Nominal value 1.6 mm
<b>Twisting element</b>	Pair
<b>Individual shielding</b>	Aluminium-bonded polyester foil, metal on the outside (PIMF)
<b>Twisting</b>	4 pairs
<b>Overall shielding</b>	Tinned copper wire braid
<b>Outer sheath</b>	halogen-free, flame-retardant compound

<b>Fire behaviour</b>	
Flame retardancy	according to IEC 60332-3-24
Halogen free	according to IEC 60754-1/2
Smoke density	according to IEC 61034-1/2
Acidity	according to EN 60754-2
Fire load (reference value)	0.74 MJ/m (Sx), 1.5 MJ/m (Dx)
EU Construction Products Regulation	according to EN 50575 / EN 50399

<b>Performance</b>	
Better than category 7 <sub>A</sub> according to EN 50288 and IEC 61156, excellent NEXT, low attenuation, excellent shielding characteristics. (shielding in pairs and overall shielding), low skew, bandwidth (typical): 1500 MHz	

<b>Applications</b>	
Installation cable for use in structured cabling according to ISO/IEC 11801 and EN 50173 (3rd edition). Ideal for all applications of Classes D to F <sub>A</sub> , multimedia (TV, video, data, voice) >10 GbE according to IEEE 802.3an, 25G in line with TR-11801-9905 in channel links up to 50 m, cable sharing, VoIP, PoE/PoE+/4PPoE.	

<b>Mechanical characteristics</b>	
Bending radius	During installation 8 x outer diameter (min.) After installation 4 x outer diameter (min.)
Tensile strength (max.)	130 N (Sx), 260 N (Dx)
Crush strength	1000 N/100 mm
Impact strength (number of shocks)	10

<b>Electromagnetic behaviour</b>	
Coupling resistance at 10 MHz (nom.)	2 mΩ/m
Screen attenuation (nom.)	80 dB
Coupling attenuation (nom.)	90 dB
Separating class according to EN 50174-2	d

### Security (fire behaviour)

	<b>1</b>	<b>2</b>	<b>3</b>	<b>4</b>	<b>5</b>
<b>S</b>	IEC 60332-2-2	IEC-60332-1-2	IEC-60332-3-24	EFP Grade 1	EFP Grade 2
		E <sub>ca</sub> /D <sub>ca</sub>	E <sub>ca</sub> /D <sub>ca</sub>	C <sub>ca</sub>	B2 <sub>ca</sub>

### Performance (cabling class, bandwidth)

	<b>1</b>	<b>2</b>	<b>3</b>	<b>4</b>	<b>5</b>
<b>P</b>	> Class E > 250 MHz	> Class E <sub>A</sub> > 500 MHz	> Class F > 600 MHz	> Class F <sub>A</sub> > 1000 MHz	> Class F <sub>A+</sub> > 1200 MHz

### Application (Ethernet, TV)

	<b>1</b>	<b>2</b>	<b>3</b>	<b>4</b>	<b>5</b>
<b>A</b>	> 100 MbE	> 1 GbE	Up to 10 GbE	> 10 GbE	> 10 GbE TV

### Construction (conductor dimension, tensile strength)

	<b>1</b>	<b>2</b>	<b>3</b>	<b>4</b>	<b>5</b>
<b>C</b>	AWG 27	AWG 26/25	AWG 24	AWG 23	AWG 22

### EMC (coupling attenuation)

	<b>1</b>	<b>2</b>	<b>3</b>	<b>4</b>	<b>5</b>
<b>E</b>	> 40 dB	> 50 dB	> 60 dB	> 70 dB	> 80 dB



## Electrical characteristics (HF) at 20°C

Frequency MHz	Attenuation dB/100 m		NEXT dB		PS-NEXT dB		ACR dB at 100 m		PS-ACR dB at 100 m		EL-FEXT dB at 100 m		PS-ELFEXT dB at 100 m		RL dB	
	Typ.	Cat. 7 <sub>A</sub> + max.*	Typ.	Cat. 7 <sub>A</sub> + min.*	Typ.	Cat. 7 <sub>A</sub> + min.*	Typ.	Cat. 7 <sub>A</sub> + min.*	Typ.	Cat. 7 <sub>A</sub> + min.*	Typ.	Cat. 7 <sub>A</sub> + min.*	Typ.	Cat. 7 <sub>A</sub> + min.*	Typ.	Cat. 7 <sub>A</sub> + min.*
1	1.6	1.9	110	80	107	77	108	78	105	75	109	80	106	77	26.1	23
10	4.2	5.4	110	78	107	75	106	72	103	69	109	74	106	71	32.3	25
100	14.4	17.5	110	76	107	73	96	58	93	55	93	54	90	51	36.2	20.1
200	21.5	25.3	110	72	107	69	88	47	85	46	86	48	83	45	35.5	18
250	24.5	28.5	105	70	102	67	81	42	78	39	83	46	80	43	34.8	17.3
500	34	41.8	105	65.5	102	62.5	71	24	68	21	70	40	67	37	31.8	17.3
600	37.7	46.3	100	64.3	97	61.3	62	18	59	15	64	38.4	61	35.4	28.5	17.3
800	44.5	54.5	95	62.5	92	59.5	50	8	47	5	58	35.9	55	32.9	25.3	16.1
900	48.1	58.4	95	61.7	92	58.7	47	3	44	0	54	34.9	51	31.9	23.8	15.5
1000	49	62	92	61	89	58	43	-1.1	40	-4	49	34	46	31	22.2	15.1
1200	54.9	69	88	59.8	85	56.8	34	-9	31	-12	40	32.4	37	29.4	20.2	14.3
1300	57	-	81	-	78	-	24	-	21	-	35	-	32	-	18.3	-
1400	58.1	-	74	-	71	-	16	-	13	-	30	-	27	-	16.3	-
1500	62	-	73	-	70	-	11	-	8	-	25	-	22	-	12.3	-

\* EN 50288-9-1(2013)/IEC 61156-5 (2009)/IEC 61156-7(2003). If IO FEXT is min. 90 dB, EL-FEXT is fulfilled by design.

## Electrical characteristics at 20°C

Direct current resistance	Max.	57.1 Ω/km
Insulation resistance	Min.	5 GΩ x km
Mutual capacitance	Approx.	42 pF/m
Capacitive coupling (e)	Approx.	1000 pF/km
Velocity of propagation (c)	Approx.	0.77
Propagation delay	Approx.	420 ns/100 m
Skew at 100 MHz	Approx.	3 ns/100 m
Charact. impedance	at 100 MHz	100 ± 5 Ω
Testing voltage U <sub>eff</sub>		1000 V
Operating voltage	Max.	125 V

## Thermal properties

For fixed installation	-20 °C up to +60 °C
For mobile operation	0°C up to +50°C

## Chemical characteristics

Free of hazardous substances according to RoHS 2011/65/EU

Dimensions	Outer Ø approx.	Weight approx.	Copper sales factor*	CPR Class	DoP no.	Sheath colour	Order no.
	mm	kg/km	kg/km				
4P	8.6	80	48	D <sub>ca</sub> s2 d2 a1	CDESK0000007	◆ Colza yellow	LKD7KS80001xxxx
2 x 4P	8.6	162	96	D <sub>ca</sub> s2 d2 a1	CDESK0000008	◆ Colza yellow	LKD7KS80010xxxx
4P	8.6	80	48	C <sub>ca</sub> s1 d1 a1	CDESK0000034	◆ Lime green	LKD7KS8C001xxxx
2 x 4P	8.6	162	96	C <sub>ca</sub> s1 d1 a1	CDESK0000040	◆ Lime green	LKD7KS8C010xxxx
4P	8.6	80	48	B2 <sub>ca</sub> s1a d1 a1	CDESK0000010	◆ Yellow green	LKD7KS8B001xxxx
2 x 4P	8.6	162	96	B2 <sub>ca</sub> s1a d1 a1	CDESK0000033	◆ Yellow green	LKD7KS8B010xxxx

Packaging: xxxx

Standard length: 0100 = 1000 m 0050 = 500 m 0000 = general

\* See page 17: Definition of copper sales factor

## Cable printing for 4P

KERPEN DATACOM Made in Germany **MegaLine®** G12-150 S/F  
4P H 25G 4PPoE "CPR Class" "DoP no." "Batch number" "Metre marking"

## Certificates and approvals

Quality mark with production control: GHMT PVP  
Link performance: KERPEN DATACOM **MegaLine®** systems  
and other commercially available connector systems  
Test certificates: according to DIN 55350-18-4.2.1 or EN 10204  
Compliant with LVD (2014/35/EU): **CE**  
Compliant with Construction Products Regulation  
(EU/305/2011): **CE**

# MegaLine® F10-130 S/F

Category 7<sub>A</sub>



Types KS-02YSCH 4x2xAWG 22/1 PIMF  
KS-02YSCH 2x(4x2xAWG 22/1 PIMF)

## Benefits

- ▶ Better than category 7<sub>A</sub>
- ▶ Bandwidth 1300 MHz
- ▶ Excellent shielding characteristics
- ▶ PVP-GHMT
- ▶ RoHS and REACH conformity

## Construction for 4P

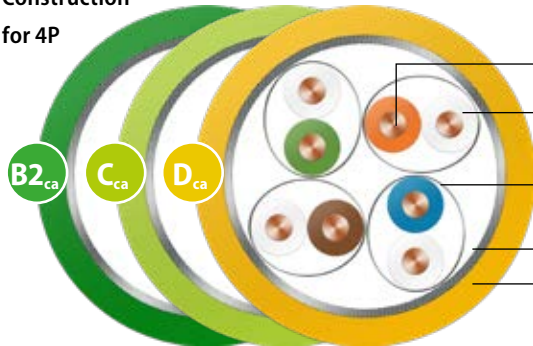

<b>Conductor</b>	Bare copper wire, AWG 22/1
<b>Insulation</b>	Foam PE, core Ø: Nominal value 1.6 mm
<b>Twisting element</b>	Pair
<b>Individual shielding</b>	Aluminium-bonded polyester foil, metal on the outside (PIMF)
<b>Twisting</b>	4 pairs
<b>Overall shielding</b>	Tinned copper wire braid
<b>Outer sheath</b>	halogen-free, flame-retardant compound

<b>Fire behaviour</b>	
Flame retardancy	according to IEC 60332-3-24
Halogen free	according to IEC 60754-1/2
Smoke density	according to IEC 61034-1/2
Acidity	according to EN 60754-2
Fire load (reference value)	0.70 MJ/m (Sx), 1.4 MJ/m (Dx)
EU Construction Products Regulation	according to EN 50575 / EN 50399

<b>Performance</b>	
Better than Category 7 <sub>A</sub> , according to EN 50288 and IEC 61156	
excellent NEXT, low attenuation,	
excellent shielding characteristics (shielding in pairs and overall shielding),	
low skew, bandwidth (typical): 1300 MHz	

<b>Applications</b>	
Installation cable for use in structured building cabling according to ISO/IEC 11801 and EN 50173 (3rd edition).	
Ideal for all applications of Classes D to F <sub>A</sub> , multimedia (video, data, voice) >10 GbE according to IEEE 802.3an, 25G in line with TR-11801-9905 in channel links up to 50 m, cable sharing, VoIP, PoE/PoE+/4PPoE.	

<b>Mechanical characteristics</b>	
Bending radius	During installation 8 x outer diameter (min.) After installation 4 x outer diameter (min.)
Tensile strength (max.)	130 N (Sx), 260 N (Dx)
Crush strength	1000 N/100 mm
Impact strength (number of shocks)	10

<b>Electromagnetic behaviour</b>	
Coupling resistance at 10 MHz (nom.)	5 mΩ/m
Screen attenuation (nom.)	70 dB
Coupling attenuation (nom.)	85 dB
Separating class according to EN 50174-2	d

## Security (fire behaviour)

	1	2	3	4	5
	IEC 60332-2-2	IEC-60332-1-2	IEC-60332-3-24	EFP Grade 1	EFP Grade 2
<b>S</b>		E <sub>ca</sub> /D <sub>ca</sub>	E <sub>ca</sub> /D <sub>ca</sub>	C <sub>ca</sub>	B2 <sub>ca</sub>

## Performance (cabling class, bandwidth)

	1	2	3	4	5
	> Class E > 250 MHz	> Class E <sub>A</sub> > 500 MHz	> Class F > 600 MHz	> Class F <sub>A</sub> > 1000 MHz	> Class F <sub>A+</sub> > 1200 MHz
<b>P</b>					

## Application (Ethernet, TV)

	1	2	3	4	5
	> 100 MbE	> 1 GbE	Up to 10 GbE	> 10 GbE	> 10 GbE TV
<b>A</b>					

## Construction (conductor dimension, tensile strength)

	1	2	3	4	5
	AWG 27	AWG 26/25	AWG 24	AWG 23	AWG 22
<b>C</b>					

## EMC (coupling attenuation)

	1	2	3	4	5
	> 40 dB	> 50 dB	> 60 dB	> 70 dB	> 80 dB
<b>E</b>					

## Electrical characteristics (HF) at 20°C

Frequency MHz	Attenuation dB/100 m		NEXT dB		PS-NEXT dB		ACR dB at 100 m		PS-ACR dB at 100 m		ACR-F dB at 100 m		PSACR-F dB at 100 m		RL dB	
	Typ.	Cat. 7 <sub>A</sub> max.*	Typ.	Cat. 7 <sub>A</sub> min.*	Typ.	Cat. 7 <sub>A</sub> min.*	Typ.	Cat. 7 <sub>A</sub> min.*	Typ.	Cat. 7 <sub>A</sub> min.*	Typ.	Cat. 7 <sub>A</sub> min.*	Typ.	Cat. 7 <sub>A</sub> min.*	Typ.	Cat. 7 <sub>A</sub> min.*
1	1.7	2.1	105	78	102	75	104	75.9	101	72.9	105	78	102	75	27.1	20
10	4.5	5.8	105	78	102	75	101	72.2	98	69.2	108	75.3	105	72.3	35.2	25
100	15.4	18.5	105	75.4	102	72.4	90	56.9	87	53.9	93	55.3	90	52.3	38.9	20.1
200	22.9	26.5	105	70.9	102	67.9	83	44.4	80	41.4	85	49.3	82	46.3	36.6	18
250	26	29.7	105	69.4	102	66.4	79	39.7	76	36.7	82	47.3	79	44.3	35.3	17.3
500	35.9	42.8	100	64.9	97	61.9	64	22.2	61	19.2	70	41.3	67	38.3	29.4	17.3
600	40.4	47.1	95	63.7	92	60.7	55	16.6	52	13.6	63	39.7	60	36.7	26.6	17.3
700	44.6	51.1	95	62.7	92	59.7	50	11.6	47	8.6	60	38.4	57	35.4	25.8	16.6
800	47.7	54.9	93	61.9	90	58.9	45	6.9	42	3.9	57	37.2	54	34.2	25	16.1
900	51.6	58.5	90	61.1	87	58.1	38	2.6	35	-0.4	53	36.2	50	33.2	23.6	15.5
1000	54.8	61.9	88	60.4	85	57.4	33	-1.5	30	-4.5	48	35.3	45	32.3	22.3	15.1
1100	56.9	-	87	-	84	-	30	-	27	-	44	-	41	-	21.4	-
1300	61.4	-	80	-	77	-	21	-	18	-	39	-	36	-	18.3	-

\* EN 50288-9-1 (2013) / IEC 61156-5 (2009). Attenuation values up to 3% higher and frequency-selective reflections can occur if multiple individual elements are configured.

## Electrical characteristics at 20°C

Direct current resistance	Max.	57.1 Ω/km
Insulation resistance	Min.	5 GΩ x km
Mutual capacitance	Approx.	40 pF/m
Capacitive coupling (e)	Approx.	1100 pF/km
Velocity of propagation (c)	Approx.	0.77
Propagation delay	Approx.	420 ns/100 m
Skew at 100 MHz	Approx.	5 ns/100 m
Charact. impedance	at 100 MHz	100 ± 5 Ω
Testing voltage U <sub>eff</sub>		1000 V
Operating voltage	Max.	125 V

## Thermal properties

For fixed installation	-20 °C up to +60 °C
For mobile operation	0°C up to +50°C

## Chemical characteristics

Free of hazardous substances according to RoHS 2011/65/EU

Dimensions	Outer Ø approx.	Weight approx.	Copper sales factor*	CPR Class	DoP no.	Sheath colour	Order no.
	mm	kg/km	kg/km				
4P	8.4	80	45	D <sub>ca</sub> s2 d2 a1	CDESK0000007	◆ Colza yellow	LKD7KS70001xxxx
2 x 4P	8.4 x 17.3	162	90	D <sub>ca</sub> s2 d2 a1	CDESK0000008	◆ Colza yellow	LKD7KS70002xxxx
4P	8.4	80	45	C <sub>ca</sub> s1 d1 a1	CDESK0000034	◆ Lime green	LKD7KS7C001xxxx
2 x 4P	8.4 x 17.3	162	90	C <sub>ca</sub> s1 d1 a1	CDESK0000040	◆ Lime green	LKD7KS7C002xxxx
4P	8.4	80	45	B2 <sub>ca</sub> s1a d1 a1	CDESK0000010	◆ Yellow green	LKD7KS7B001xxxx
2 x 4P	8.4 x 17.3	162	90	B2 <sub>ca</sub> s1a d1 a1	CDESK0000033	◆ Yellow green	LKD7KS7B002xxxx

Packaging: xxxx

Standard length: 0100 = 1000 m 0050 = 500 m 0000 = general

\* See page 17: Definition of copper sales factor

## Cable printing for 4 P

KERPEN DATACOM Made in Germany **MegaLine®** F10-130 S/F  
4P H 25G 4PPoE "CPR Class" "DoP no." "Batch number" "Metre  
marking"

## Certificates and approvals

Quality mark with production control: GHMT PVP  
Link performance: KERPEN DATACOM **MegaLine®** systems  
and other commercially available connector systems  
Test certificates: according to DIN 55350-18-4.2.1 or EN 10204  
Compliant with LVD (2014/35/EU): **CE**  
Compliant with Construction Products Regulation  
(EU/305/2011): **CE**

# MegaLine® F10-125 S/F

## Category 7<sub>A</sub>



Types KS-02YSCH 4x2x0.62 mm/~AWG 22/1 PIMF  
KS-02YSCH 2x(4x2x0.62 mm/~AWG 22/1 PIMF)

### Benefits

- ▶ Better than category 7<sub>A</sub>
- ▶ Bandwidth 1300 MHz
- ▶ Excellent shielding characteristics
- ▶ PVP-GHMT
- ▶ RoHS and REACH conformity

### Construction for 4P

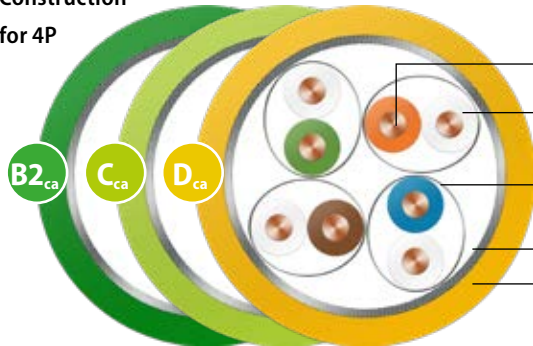

<b>Conductor</b>	Bare copper wire, 0.62 mm/~AWG 22/1
<b>Insulation</b>	Foam PE, coreØ: Nominal value 1.5 mm
<b>Twisting element</b>	Pair
<b>Individual shielding</b>	Aluminium-bonded polyester foil, metal on the outside (PiMF)
<b>Twisting</b>	4 pairs
<b>Overall shielding</b>	Tinned copper wire braid
<b>Outer sheath</b>	halogen-free, flame-retardant compound

### Fire behaviour

Flame retardancy	according to IEC 60332-3-24
Halogen free	according to IEC 60754-1/2
Smoke density	according to IEC 61034-1/2
Fire load (reference value)	0.65 MJ/m (Sx), 1.33 MJ/m (Dx)
Acidity	according to EN 60754-2
EU Construction Products Regulation	according to EN 50575 / EN 50399

### Performance

Better than Category 7<sub>A</sub> according to EN 50288 and IEC 61156  
Excellent NEXT, low attenuation,  
excellent shielding characteristics (shielding in pairs and overall shielding),  
low skew, bandwidth (typical): 1300 MHz

### Applications

Installation cable for use in structured building cabling according to ISO/IEC 11801 and EN 50173 (3rd edition). Ideal for all applications of Classes D to F<sub>AT</sub> multimedia (video, data, voice) >10 GbE according to IEEE 802.3an, 25G in line with TR-11801-9905 in channel links up to 50 m, cable sharing, VoIP, PoE/PoE+/4PPoE.

### Mechanical characteristics

Bending radius	During installation	8 x outer diameter (min.)
	After installation	4 x outer diameter (min.)
Tensile strength (max.)		110 N (Sx), 220 N (Dx)
Crush strength		1000 N/100 mm
Impact strength (number of shocks)		10

### Electromagnetic behaviour

Coupling resistance at 10 MHz (nom.)	5 mΩ/m
Screen attenuation (nom.)	70 dB
Coupling attenuation (nom.)	85 dB
Separating class according to EN 50174-2	d

### Security (fire behaviour)

S	1 IEC 60332-2-2	2 IEC-60332-1-2	3 IEC-60332-3-24	4 EFP Grade 1	5 EFP Grade 2
		E <sub>ca</sub> /D <sub>ca</sub>	E <sub>ca</sub> /D <sub>ca</sub>	C <sub>ca</sub>	B2 <sub>ca</sub>

### Performance (cabling class, bandwidth)

P	1 > Class E > 250 MHz	2 > Class E <sub>A</sub> > 500 MHz	3 > Class F > 600 MHz	4 > Class F <sub>A</sub> > 1000 MHz	5 > Class F <sub>A+</sub> > 1200 MHz

### Application (Ethernet, TV)

A	1 > 100 MbE	2 > 1 GbE	3 Up to 10 GbE	4 > 10 GbE	5 > 10 GbE TV

### Construction (conductor dimension, tensile strength)

C	1 AWG 27	2 AWG 26/25	3 AWG 24	4 AWG 23	5 AWG 22

### EMC (coupling attenuation)

E	1 > 40 dB	2 > 50 dB	3 > 60 dB	4 > 70 dB	5 > 80 dB

## Electrical characteristics (HF) at 20°C

Frequency MHz	Attenuation dB/100 m		NEXT dB		PS-NEXT dB		ACR dB at 100 m		PS-ACR dB at 100 m		EL-FEXT dB at 100 m		PS-ELFEXT dB at 100 m		RL dB	
	Typ.	Cat. 7 <sub>A</sub> max.*	Typ.	Cat. 7 <sub>A</sub> min.*	Typ.	Cat. 7 <sub>A</sub> min.*	Typ.	Cat. 7 <sub>A</sub> min.*	Typ.	Cat. 7 <sub>A</sub> min.*	Typ.	Cat. 7 <sub>A</sub> min.*	Typ.	Cat. 7 <sub>A</sub> min.*	Typ.	Cat. 7 <sub>A</sub> min.*
1	1.8	2.1	105	78	102	75	104	75.9	101	72.9	105	78	102	75	27.1	20
10	4.7	5.8	105	78	102	75	101	72.2	98	69.2	108	75.3	105	72.3	35.2	25
100	15.9	18.5	105	75.4	102	72.4	89	56.9	86	53.9	93	55.3	90	52.3	38.9	20.1
200	23.5	26.5	105	70.9	102	67.9	81	44.4	78	41.4	85	49.3	82	46.3	36.6	18
250	26.6	29.7	105	69.4	102	66.4	79	39.7	76	36.7	82	47.3	79	44.3	35.3	17.3
500	37	42.8	100	64.9	97	61.9	63	22.2	60	19.2	70	41.3	67	38.3	29.4	17.3
600	41.8	47.1	95	63.7	92	60.7	53	16.6	50	13.6	63	39.7	60	36.7	26.6	17.3
700	45.2	51.1	95	62.7	92	59.7	50	11.6	47	8.6	60	38.4	57	35.4	25.8	16.6
800	48	54.9	93	61.9	90	58.9	45	6.9	42	3.9	57	37.2	54	34.2	25	16.1
900	52.3	58.5	90	61.1	87	58.1	38	2.6	35	-0.4	53	36.2	50	33.2	23.6	15.5
1000	55.2	61.9	88	60.4	85	57.4	33	-1.5	30	-4.5	48	35.3	45	32.3	22.3	15.1
1100	57.6	-	87	-	84	-	29	-	26	-	44	-	41	-	21.4	-
1300	64.9	-	80	-	77	-	15	-	13	-	39	-	36	-	18.3	-

\* EN 50288-9-1(2013)/IEC 61156-5 (2009)

## Electrical characteristics at 20°C

Direct current resistance	Max.	65 Ω/km
Insulation resistance	Min.	5 GΩ x km
Mutual capacitance	Approx.	42 pF/m
Capacitive coupling (e)	Approx.	1100 pF/km
Velocity of propagation (c)	Approx.	0.80
Propagation delay	Approx.	420 ns/100 m
Skew at 100 MHz	Approx.	5 ns/100 m
Charact. impedance	at 100 MHz	100 ± 5 Ω
Testing voltage U <sub>eff</sub>		1000 V
Operating voltage	Max.	125 V

## Thermal properties

For fixed installation	-20 °C up to +60 °C
For mobile operation	0°C up to +50°C

## Chemical characteristics

Free of hazardous substances according to RoHS 2011/65/EU

## Cable printing for 4 P

KERPEN DATACOM Made in Germany **MegaLine®** F10-125 S/F 4P  
H 25G 4PPoE "CPR Class" "DoP no." "Batch number" "Metre marking"

## Certificates and approvals

Quality mark with production control: GHMT PVP  
Link performance: KERPEN DATACOM **MegaLine®** systems  
and other commercially available connector systems  
Test certificates: according to DIN 55350-18-4.2.1 or EN 10204  
Compliant with LVD (2014/35/EU): **CE**  
Compliant with Construction Products Regulation  
(EU/305/2011): **CE**

Dimensions	Outer Ø approx.	Weight approx.	Copper sales factor*	CPR Class	DoP no.	Sheath colour	Order no.
	mm	kg/km	kg/km				
4P	8.1	68	38	D <sub>ca</sub> s2 d2 a1	CDESK0000007	◆ Colza yellow	LKD7KS70253xxxx
2 x 4P	8.0 x 16.4	141	76	D <sub>ca</sub> s2 d2 a1	CDESK0000008	◆ Colza yellow	LKD7KS70293xxxx
4P	8.1	68	38	C <sub>ca</sub> s1 d1 a1	CDESK0000034	◆ Lime green	LKD7KS7C253xxxx
2 x 4P	8.0 x 16.4	142	76	C <sub>ca</sub> s1 d1 a1	CDESK0000040	◆ Lime green	LKD7KS7C293xxxx
4P	8.1	68	38	B2 <sub>ca</sub> s1a d1 a1	CDESK0000010	◆ Yellow green	LKD7KS7B253xxxx

Packaging: xxxx

Standard length: 0100 = 1000 m 0050 = 500 m 0000 = general

\* See page 17: Definition of copper sales factor

# MegaLine® F10-115 S/F

Category 7<sub>A</sub>



Types KS-02YSCH 4x2xAWG 23/1 PIMF  
KS-02YSCH 2x(4x2xAWG 23/1 PIMF)

## Benefits

- ▶ Better than category 7<sub>A</sub>
- ▶ Bandwidth 1200 MHz
- ▶ Excellent shielding characteristics
- ▶ PVP-GHMT
- ▶ RoHS and REACH conformity

## Construction for 4P

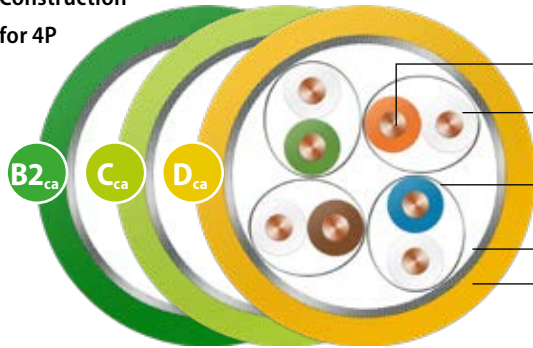

<b>Conductor</b>	Bare copper wire, AWG 23/1
<b>Insulation</b>	Foam PE, core Ø: Nominal value 1.4 mm
<b>Twisting element</b>	Pair
<b>Individual shielding</b>	Aluminium-bonded polyester foil, metal on the outside (PIMF)
<b>Twisting</b>	4 pairs
<b>Overall shielding</b>	Tinned copper wire braid
<b>Outer sheath</b>	halogen-free, flame-retardant compound

## Fire behaviour

Flame retardancy	according to IEC 60332-3-24
Halogen free	according to IEC 60754-1/2
Smoke density	according to IEC 61034-1/2
Acidity	according to EN 60754-2
Fire load (reference value)	0.60 MJ/m (S <sub>x</sub> ), 1.2 MJ/m (D <sub>x</sub> )
EU Construction Products Regulation	according to EN 50575 / EN 50399

## Performance

Better than category 7<sub>A</sub> according to EN 50288 and IEC 61156, Excellent NEXT, low attenuation, excellent shielding characteristics (shielding in pairs and overall shielding), low skew, bandwidth (typical): 1200 MHz

## Applications

Installation cable for use in structured building cabling according to ISO/IEC 11801 and EN 50173 (3rd edition). Ideal for all applications of Classes D to F<sub>xx</sub>, multimedia (video, data, voice) > 10 GbE according to IEEE 802.3 an, cable sharing, VoIP, PoE/PoE+/4PPoE.

## Mechanical characteristics

Bending radius	During installation	8 x outer diameter (min.)
	After installation	4 x outer diameter (min.)
Tensile strength (max.)		110 N (S <sub>x</sub> ), 220 N (D <sub>x</sub> ), 440 n (4-fold), 650 N (6-fold)
		1000 N/100 mm
Crush strength		10
Impact strength (number of shocks)		10

## Electromagnetic behaviour

Coupling resistance at 10 MHz (nom.)	5 mΩ/m
Screen attenuation (nom.)	70 dB
Coupling attenuation (nom.)	85 dB
Separating class according to EN 50174-2	d

## Security (fire behaviour)

S	1	2	3	4	5
	IEC 60332-2-2	IEC-60332-1-2	IEC-60332-3-24	EFP Grade 1	EFP Grade 2
		E <sub>ca</sub> /D <sub>ca</sub>	E <sub>ca</sub> /D <sub>ca</sub>	C <sub>ca</sub>	B2 <sub>ca</sub>

## Performance (cabling class, bandwidth)

P	1	2	3	4	5
	> Class E > 250 MHz	> Class E <sub>x</sub> > 500 MHz	> Class F > 600 MHz	> Class F <sub>x</sub> > 1000 MHz	> Class F <sub>x</sub> + > 1200 MHz

## Application (Ethernet, TV)

A	1	2	3	4	5
	> 100 MbE	> 1 GbE	Up to 10 GbE	> 10 GbE	> 10 GbE TV

## Construction (conductor dimension, tensile strength)

C	1	2	3	4	5
	AWG 27	AWG 26/25	AWG 24	AWG 23	AWG 22

## EMC (coupling attenuation)

E	1	2	3	4	5
	> 40 dB	> 50 dB	> 60 dB	> 70 dB	> 80 dB

## Electrical characteristics (HF) at 20°C

Frequency MHz	Attenuation dB/100 m		NEXT dB		PS-NEXT dB		ACR dB at 100 m		PS-ACR dB at 100 m		EL-FEXT dB at 100 m		PS-ELFEXT dB at 100 m		RL dB	
	Typ.	Cat. 7 <sub>A</sub> max.*	Typ.	Cat. 7 <sub>A</sub> min.*	Typ.	Cat. 7 <sub>A</sub> min.*	Typ.	Cat. 7 <sub>A</sub> min.*	Typ.	Cat. 7 <sub>A</sub> min.*	Typ.	Cat. 7 <sub>A</sub> min.*	Typ.	Cat. 7 <sub>A</sub> min.*	Typ.	Cat. 7 <sub>A</sub> min.*
1	1.9	2.1	105	78	102	75	104	75.9	101	72.9	98	78	95	75	26.6	20
10	4.8	5.8	105	78	102	75	101	72.2	98	69.2	103	75.3	100	72.3	35.3	25
100	16.3	18.5	105	75.4	102	72.4	89	56.9	86	53.9	89	55.3	86	52.3	39.6	20.1
200	24.3	26.5	105	70.9	102	67.9	81	44.4	78	41.4	82	49.3	79	46.3	36	18
250	27.5	29.7	105	69.4	102	66.4	78	39.7	75	36.7	79	47.3	76	44.3	34	17.3
500	37.9	42.8	100	64.9	97	61.9	62	22.2	59	19.2	67	41.3	64	38.3	29	17.3
600	42.4	47.1	95	63.7	92	60.7	53	16.6	50	13.6	60	39.7	57	36.7	25.4	17.3
700	47.2	51.1	95	62.7	92	59.7	48	11.6	45	8.6	57	38.4	54	35.4	24.6	16.6
800	50.3	54.9	93	61.9	90	58.9	43	6.9	40	3.9	53	37.2	50	34.2	23.5	16.1
900	54.6	58.5	90	61.1	87	58.1	35	2.6	32	-0.4	49	36.2	46	33.2	22.6	15.5
1000	58	61.9	88	60.4	85	57.4	30	-1.5	27	-4.5	44	35.3	41	32.3	21.5	15.1
1150	61.9	-	86	-	83	-	25	-	22	-	39	-	36	-	20.6	-
1200	64	-	85	-	82	-	21	-	18	-	35	-	32	-	19	-

\* EN 50288-9-1 (2013)/IEC 61156-5 (2009)

## Electrical characteristics at 20°C

Direct current resistance	Max.	75 Ω/km
Insulation resistance	Min.	5 GΩ x km
Mutual capacitance	Approx.	42 pF/m
Capacitive coupling (e)	Approx.	1100 pF/km
Velocity of propagation (c)	Approx.	0.8
Propagation delay	Approx.	420 ns/100 m
Skew at 100 MHz	Approx.	5 ns/100 m
Charact. impedance	at 100 MHz	100 ± 5 Ω
Testing voltage U <sub>eff</sub>		1000 V
Operating voltage	Max.	125 V

## Thermal properties

For fixed installation	-20 °C up to +60 °C
For mobile operation	0°C up to +50°C

## Chemical characteristics

Free of hazardous substances according to RoHS 2011/65/EU

## Cable printing for 4 P

KERPEN DATACOM Made in Germany **MegaLine®** F10-115 S/F 4P H  
"CPR Class" "DoP no." "Batch number" "Metre marking"

## Certificates and approvals

Quality mark with production control: GHMT PVP  
Link performance: KERPEN DATACOM **MegaLine®** systems  
and other commercially available connector systems  
Test certificates: according to DIN 55350-18-4.2.1 or EN 10204  
Compliant with LVD (2014/35/EU): **CE**  
Compliant with Construction Products Regulation  
(EU/305/2011): **CE**

Dimensions	Outer Ø approx.	Weight approx.	Copper sales factor*	CPR Class	DoP no.	Sheath colour	Order no.
	mm	kg/km	kg/km				
4P	7.5	67	37	D <sub>ca</sub> s2 d2 a1	CDESK0000005	◆ Colza yellow	LKD7KS70008xxxx
2 x 4P	7.5 x 15.2	136	74	D <sub>ca</sub> s2 d2 a1	CDESK0000006	◆ Colza yellow	LKD7KS70009xxxx
4P	7.4	57	37	C <sub>ca</sub> s1 d1 a1	CDESK0000035	◆ Lime green	LKD7KS7C008xxxx
4P	7.4	57	37	B2 <sub>ca</sub> s1a d1 a1	CDESK0000009	◆ Yellow green	LKD7KS7B008xxxx

Packaging: xxxx

Standard length: 0100 = 1000 m 0050 = 500 m 0000 = general

\* See page 17: Definition of copper sales factor

# MegaLine® F6-90 S/F

## Category 7



Types KS-02YSCH 4x2xAWG 23/1 PIMF  
KS-02YSCH 2x(4x2xAWG 23/1 PIMF)

### Benefits

- ▶ Better than category 7
- ▶ Bandwidth 1000 MHz
- ▶ Excellent shielding characteristics
- ▶ PVP-GHMT
- ▶ RoHS and REACH conformity

### Construction for 4P

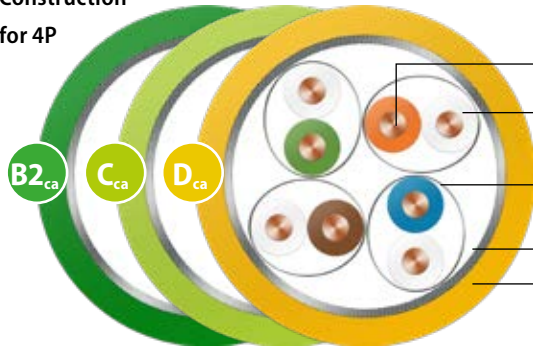

<b>Conductor</b>	Bare copper wire, AWG 23/1
<b>Insulation</b>	Foam PE, core Ø: Nominal value 1.4 mm
<b>Twisting element</b>	Pair
<b>Individual shielding</b>	Aluminium-bonded polyester foil, metal on the outside (PIMF)
<b>Twisting</b>	4 pairs
<b>Overall shielding</b>	Tinned copper wire braid
<b>Outer sheath</b>	halogen-free, flame-retardant compound

### Fire behaviour

Flame retardancy	according to IEC 60332-3-24
Halogen free	according to IEC 60754-1/2
Smoke density	according to IEC 61034-1/2
Acidity	according to EN 60754-2
Fire load (reference value)	0.60 MJ/m (Sx), 1.2 MJ/m (Dx)
EU Construction Products Regulation	according to EN 50575 / EN 50399

### Performance

Better than Category 7 according to EN 50288 and IEC 61156  
Excellent NEXT, excellent shielding characteristics (pairs and overall shielding), low skew, bandwidth (typical): 1000 MHz

### Applications

Installation cable for use in structured building cabling according to ISO/IEC 11801 and EN 50173 (3rd edition). Ideal for all applications of Classes D to F, multimedia (video, data, voice) > 10 GbE according to IEEE 802.3an, cable sharing, VoIP, PoE/PoE+/4PPoE.

### Mechanical characteristics

Bending radius	During installation	8 x outer diameter (min.)
	After installation	4 x outer diameter (min.)
Tensile strength (max.)		110 N (Sx), 220 N (Dx), 400 N (4-fold), 600 N (6-fold), 850 N (8-fold)
Crush strength		1000 N/100 mm
Impact strength (number of shocks)		10

### Electromagnetic behaviour

Coupling resistance at 10 MHz (nom.)	5 mΩ/m
Screen attenuation (nom.)	70 dB
Coupling attenuation (nom.)	85 dB
Separating class according to EN 50174-2	d

### Security (fire behaviour)

S	1 IEC 60332-2-2	2 IEC-60332-1-2 E <sub>ca</sub> /D <sub>ca</sub>	3 IEC-60332-3-24 E <sub>ca</sub> /D <sub>ca</sub>	4 EFP Grade 1 C <sub>ca</sub>	5 EFP Grade 2 B2 <sub>ca</sub>
---	--------------------	--	---	-------------------------------------	--------------------------------------

### Performance (cabling class, bandwidth)

P	1 > Class E > 250 MHz	2 > Class E <sub>A</sub> > 500 MHz	3 > Class F > 600 MHz	4 > Class F <sub>A</sub> > 1000 MHz	5 > Class F <sub>A</sub> + > 1200 MHz
---	-----------------------------	--	-----------------------------	---	---

### Application (Ethernet, TV)

A	1 > 100 MbE	2 > 1 GbE	3 Up to 10 GbE	4 > 10 GbE	5 > 10 GbE TV
---	----------------	--------------	-------------------	---------------	------------------

### Construction (conductor dimension, tensile strength)

C	1 AWG 27	2 AWG 26/25	3 AWG 24	4 AWG 23	5 AWG 22
---	-------------	----------------	-------------	-------------	-------------

### EMC (coupling attenuation)

E	1 > 40 dB	2 > 50 dB	3 > 60 dB	4 > 70 dB	5 > 80 dB
---	--------------	--------------	--------------	--------------	--------------



### Electrical characteristics (HF) at 20°C

Frequency MHz	Attenuation dB/100 m		NEXT dB		PS-NEXT dB		ACR dB at 100 m		PS-ACR dB at 100 m		EL-FEXT dB at 100 m		PS-ELFEXT dB at 100 m		RL dB	
	Typ.	Cat. 7 max.*	Typ.	Cat. 7 min.*	Typ.	Cat. 7 min.*	Typ.	Cat. 7 min.*	Typ.	Cat. 7 min.*	Typ.	Cat. 7 min.*	Typ.	Cat. 7 min.*	Typ.	Cat. 7 min.*
1	1.9	2	102	80	99	77	101	78	98	75	109	80	106	77	29	23
10	4.8	5.7	102	80	99	77	98	74	95	71	108	74	105	71	28	25
100	16.4	18.5	102	72	99	69	86	54	83	51	93	54	90	51	27	20.1
200	24.5	26.8	102	68	99	65	78	41	75	38	85	48	82	45	25	18
250	27.8	30.2	102	66	99	63	75	36	72	33	82	46	79	43	24	17.3
450	36.1	41.6	97	63	94	60	61	21	58	18	72	41	69	38	22	17.3
500	38.2	44.1	97	62	94	59	59	18	56	15	68	40	65	37	21	17.3
600	42.9	48.9	92	61	89	58	49	12	46	9	62	38	59	35	20	17.3
700	47.7	-	92	-	89	-	44	-	41	-	59	-	56	-	19	-
800	50.8	-	90	-	87	-	39	-	36	-	56	-	53	-	18	-
900	55.1	-	85	-	82	-	30	-	27	-	52	-	49	-	17	-
1000	58.0	-	80	-	77	-	22	-	19	-	42	-	39	-	15	-

\* EN 50288-4-1 (2014)/IEC 61156-5 (2009)

### Electrical characteristics at 20°C

Direct current resistance	Max.	75 Ω/km
Insulation resistance	Min.	5 GΩ x km
Mutual capacitance	Approx.	42 pF/m
Capacitive coupling (e)	Approx.	1100 pF/km
Velocity of propagation (c)	Approx.	0.79
Propagation delay	Approx.	420 ns/100 m
Skew at 100 MHz	Approx.	5 ns/100 m
Charact. impedance	at 100 MHz	100 ± 5 Ω
Testing voltage U <sub>eff</sub>		1000 V
Operating voltage	Max.	125 V

### Thermal properties

For fixed installation	-20 °C up to +60 °C
For mobile operation	0°C up to +50°C

### Chemical characteristics

Free of hazardous substances according to RoHS 2011/65/EU

Dimensions	Outer Ø approx.	Weight approx.	Copper sales factor*	CPR Class	DoP no.	Sheath colour	Order no.
	mm	kg/km	kg/km				
4P	7.4	57	35	D <sub>ca</sub> s2 d2 a1	CDESK0000005	◆ Colza yellow	LKD7KS70010xxxx
2 x 4P	7.5 x 15.2	117	70	D <sub>ca</sub> s2 d2 a1	CDESK0000006	◆ Colza yellow	LKD7KS70011xxxx
4P	7.4	57	35	C <sub>ca</sub> s1 d1 a1	CDESK0000035	◆ Lime green	LKD7KS7C010xxxx
2 x 4P	7.5 x 15.2	117	70	C <sub>ca</sub> s1 d1 a1	CDESK0000039	◆ Lime green	LKD7KS7C011xxxx
4P	7.4	57	35	B2 <sub>ca</sub> s1a d1 a1	CDESK0000009	◆ Yellow green	LKD7KS7B010xxxx
2 x 4P	7.5 x 15.2	117	70	B2 <sub>ca</sub> s1a d1 a1	CDESK0000032	◆ Yellow green	LKD7KS7B011xxxx

Packaging: xxxx

Standard length: 0100 = 1000 m 0050 = 500 m 0000 = general

\* See page 17: Definition of copper sales factor

### Cable printing for 4P

KERPEN DATACOM Made in Germany **MegaLine®** F6-90 S/F 4P H  
"CPR Class" "DoP no." "Batch number" "Metre marking"

### Certificates and approvals

Quality mark with production control: GHMT PVP  
Link performance: KERPEN DATACOM **MegaLine®** systems  
and other commercially available connector systems  
Test certificates: according to DIN 55350-18-4.2.1 or EN 10204  
Compliant with LVD (2014/35/EU): **CE**  
Compliant with Construction Products Regulation  
(EU/305/2011): **CE**

# MegaLine® F6-90 S/F CI

## Category 7



Type KS-02YSCH CI 4x2xAWG 23/1 PIMF

### Benefits

- ▶ Better than category 7
- ▶ Bandwidth 900 MHz
- ▶ Excellent shielding characteristics
- ▶ RoHS and REACH conformity

Total system integrity in the event of fire for at least

**120 minutes**

### Construction for 4P

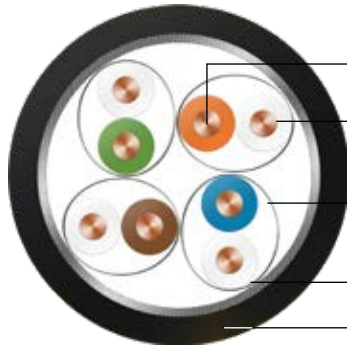

<b>Conductor</b>	Bare copper wire, AWG 23/1
<b>Insulation</b>	Foam PE, core Ø: Nominal value 1.4 mm
<b>Twisting element</b>	Pair
<b>Taping</b>	Fire protection tape
<b>Individual shielding</b>	Aluminium-bonded polyester foil, metal on the outside (PiMF)
<b>Twisting</b>	4 pairs
<b>Overall shielding</b>	Tinned copper wire braid, opt. 80% coverage
<b>Taping</b>	Fire protection tape
<b>Outer sheath</b>	halogen-free, flame-retardant compound

### Fire behaviour

Flame retardancy	IEC 60332-3-24/22, IEC 60332-1-2
Halogen free	according to IEC 60754-1/2
Smoke density	according to IEC 61034-1/2
Fire load (reference value)	1.05 MJ/m

### Performance

Better than Category 7 according to EN 50288 and IEC 61156, excellent NEXT, Excellent NEXT, excellent shielding characteristics (pairs and overall shielding), low skew, insulation integrity in line with IEC 60331-23 (FE180) and total system integrity in accordance with EN 50200 (PH120) and EN 50289-4-16 (Cat. 6), bandwidth (typical): 900 MHz

### Applications

Installation cable for use in structured cabling according to ISO/IEC 11801 and EN 50173 (3rd edition). Ideal for all applications of Classes D to F, multimedia (video, data, voice) > 10 GbE according to IEEE 802.3an, cable sharing, VoIP, PoE/ PoE+/4PPoE and for IT cable systems with insulation / total system integrity.

### Mechanical characteristics

Bending radius	During installation	8 x outer diameter (min.)
	After installation	4 x outer diameter (min.)
Tensile strength (max.)		110 N
Crush strength		2000 N/100 mm
Impact strength (number of shocks)		20

### Electromagnetic behaviour

Coupling resistance at 10 MHz (nom.)	5 mΩ/m
Screen attenuation (nom.)	70 dB
Coupling attenuation (nom.)	85 dB
Separating class according to EN 50174-2	d

### Security (fire behaviour)

<b>S</b>	1 IEC 60332-2-2	2 IEC-60332-1-2	3 IEC-60332-3-24	4 EFP Grade 1	5 EFP Grade 2
----------	--------------------	--------------------	---------------------	------------------	------------------

### Performance (cabling class, bandwidth)

<b>P</b>	1 > Class E > 250 MHz	2 > Class E <sub>A</sub> > 500 MHz	3 > Class F > 600 MHz	4 > Class F <sub>A</sub> > 1000 MHz	5 > Class F <sub>A</sub> + > 1200 MHz
----------	-----------------------------	--	-----------------------------	---	---

### Application (Ethernet, TV)

<b>I</b>	1 > 100 MbE	2 > 1 GbE	3 Up to 10 GbE	4 > 10 GbE	5 > 10 GbE TV
----------	----------------	--------------	-------------------	---------------	------------------

### Construction (conductor dimension, tensile strength)

<b>C</b>	1 AWG 27	2 AWG 26/25	3 AWG 24	4 AWG 23	5 AWG 22
----------	-------------	----------------	-------------	-------------	-------------

### EMC (coupling attenuation)

<b>E</b>	1 > 40 dB	2 > 50 dB	3 > 60 dB	4 > 70 dB	5 > 80 dB
----------	--------------	--------------	--------------	--------------	--------------

### Electrical characteristics (HF) at 20°C

Frequency MHz	Attenuation dB/100 m		NEXT dB		PS-NEXT dB		ACR dB at 100 m		PS-ACR dB at 100 m		EL-FEXT dB at 100 m		PS-ELFEXT dB at 100 m		RL dB	
	Typ.	Cat. 7 max.*	Typ.	Cat. 7 min.*	Typ.	Cat. 7 min.*	Typ.	Cat. 7 min.*	Typ.	Cat. 7 min.*	Typ.	Cat. 7 min.*	Typ.	Cat. 7 min.*	Typ.	Cat. 7 min.*
1	1.9	2	102	80	99	77	101	78	98	75	109	80	106	77	29	23
10	4.8	5.7	102	80	99	77	98	74	95	71	108	74	105	71	28	25
100	16.4	18.5	102	72	99	69	86	54	83	51	93	54	90	51	27	21.1
200	24.5	26.8	102	68	99	65	78	41	75	38	85	48	82	45	25	18
250	27.8	30.2	102	66	99	63	75	36	72	33	82	46	79	43	24	17.3
450	36.1	41.6	97	63	94	60	61	21	58	18	72	41	69	38	22	17.3
500	38.2	44.1	97	62	94	59	59	18	56	15	68	40	65	37	21	17.3
600	42.9	48.9	92	61	89	58	49	12	46	9	62	38	59	35	20	17.3
700	47.7	-	92	-	89	-	44	-	41	-	59	-	56	-	19	-
800	50.8	-	90	-	87	-	39	-	36	-	56	-	53	-	18	-
900	55.1	-	85	-	82	-	30	-	27	-	52	-	49	-	17	-

\* EN 50288-4-1 (2014)/IEC 61156-5 (2009)

### Electrical characteristics at 20°C

Direct current resistance	Max.	75 Ω/km
Insulation resistance	Min.	5 GΩ x km
Mutual capacitance	Approx.	42 pF/m
Capacitive coupling (e)	Approx.	1100 pF/km
Velocity of propagation (c)	Approx.	0.74
Propagation delay	Approx.	420 ns/100 m
Skew at 100 MHz	Approx.	5 ns/100 m
Charact. impedance	at 100 MHz	100 ± 5 Ω
Testing voltage U <sub>eff</sub>		1000 V
Operating voltage	Max.	125 V

### Thermal properties

For fixed installation	-25 °C up to +75 °C
For mobile operation	-10 °C up to +50°C

### Chemical characteristics

Free of hazardous substances according to RoHS 2011/65/EU  
 UV resistance according to UL 1581 and ISO 4892  
 Free of lacquer-wetting substances (e.g. silicon oil)

### Cable printing

KERPEN DATACOM Made in Germany **MegaLine®** F6-90 S/F CI  
 4P H FIRE RESTISTANT EN 50289-4-16 EN 50200 PH120 "Batch  
 number" "Metre marking"

### Certificates and approvals

Link performance: KERPEN DATACOM **MegaLine®** systems  
 and other commercially available connector systems  
 Test certificates: according to DIN 55350-18-4.2.1 or EN 10204  
 Compliant with LVD (2014/35/EU): **CE**

Dimensions	Outer Ø approx.	Weight approx.	Copper sales factor*	CPR Class	DoP no.	Sheath colour	Order no.
	mm	kg/km	kg/km				
4P	10.5	133	54.9	B2 <sub>o</sub> s1a d0 a1	CDERF0000004	◆ Jet black	LKD7KS703240000

Package: Drum 1000 m

\* See page 17: Definition of copper sales factor

# MegaLine® E5-70 S/F

Category 6<sub>A</sub>



Types KS-02YSCH 4x2xAWG 23/1 PIMF  
KS-02YSCH 2x(4x2xAWG 23/1 PIMF)

## Benefits

- ▶ Better than category 6<sub>A</sub>
- ▶ Bandwidth 700 MHz
- ▶ Excellent shielding characteristics
- ▶ RoHS and REACH conformity

## Construction for 4P

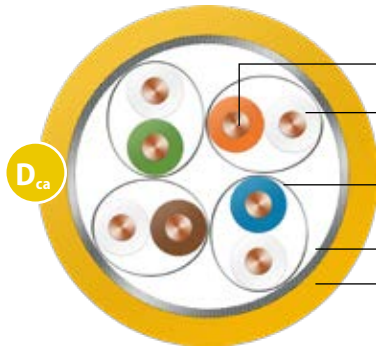

<b>Conductor</b>	Bare copper wire, AWG 23/1
<b>Insulation</b>	Foam PE, core Ø: Nominal value 1.24 mm
<b>Twisting element</b>	Pair
<b>Individual shielding</b>	Aluminium-bonded polyester foil, metal on the outside (PiMF)
<b>Twisting</b>	4 pairs
<b>Overall shielding</b>	Tinned copper wire braid
<b>Outer sheath</b>	halogen-free, flame-retardant compound

## Fire behaviour

Flame retardancy	according to IEC 60332-3-24
Halogen free	according to IEC 60754-1/2
Smoke density	according to IEC 61034-1/2
Acidity	according to EN 60754-2
Fire load (reference value)	0.60 MJ/m (Sx), 1.2 MJ/m (Dx)
EU Construction Products Regulation	according to EN 50575 / EN 50399

## Performance

Better than category 6<sub>A</sub>, according to EN 50288 and IEC 61156, excellent NEXT, good shielding characteristics (shielding in pairs or overall shielding), low skew, bandwidth (typical): 700 MHz

## Applications

Installation cable for use in structured building cabling according to ISO/IEC 11801 and EN 50173 (3rd edition).  
Ideal for all applications of Classes D to E<sub>x</sub>, up to 10 GbE according to IEEE 802.3an, cable sharing, VoIP, PoE/PoE+/4PPoE.

## Mechanical characteristics

Bending radius	During installation	8 x outer diameter (min.)
	After installation	4 x outer diameter (min.)
Tensile strength (max.)		110 N (Sx), 220 N (Dx)
Crush strength		1000 N/100 mm
Impact strength (number of shocks)		10

## Electromagnetic behaviour

Coupling resistance at 10 MHz (nom.)	5 mΩ/m
Screen attenuation (nom.)	60 dB
Coupling attenuation (nom.)	80 dB
Separating class according to EN 50174-2	c

## Security (fire behaviour)

<b>S</b>	1 IEC 60332-2-2	2 IEC-60332-1-2 <b>E<sub>ca</sub>/D<sub>ca</sub></b>	3 IEC-60332-3-24 <b>E<sub>ca</sub>/D<sub>ca</sub></b>	4 EFP Grade 1 <b>C<sub>ca</sub></b>	5 EFP Grade 2 <b>B2<sub>ca</sub></b>
----------	--------------------	--	---	---	--

## Performance (cabling class, bandwidth)

<b>P</b>	1 > Class E > 250 MHz	2 > Class E <sub>x</sub> > 500 MHz	3 > Class F > 600 MHz	4 > Class F <sub>x</sub> > 1000 MHz	5 > Class F <sub>x</sub> + > 1200 MHz
----------	-----------------------------	--	-----------------------------	---	---

## Application (Ethernet, TV)

<b>A</b>	1 > 100 MbE	2 > 1 GbE	3 Up to 10 GbE	4 > 10 GbE	5 > 10 GbE TV
----------	----------------	--------------	-------------------	---------------	------------------

## Construction (conductor dimension, tensile strength)

<b>C</b>	1 AWG 27	2 AWG 26/25	3 AWG 24	4 AWG 23	5 AWG 22
----------	-------------	----------------	-------------	-------------	-------------

## EMC (coupling attenuation)

<b>E</b>	1 > 40 dB	2 > 50 dB	3 > 60 dB	4 > 70 dB	5 > 80 dB
----------	--------------	--------------	--------------	--------------	--------------

### Electrical characteristics (HF) at 20°C

Frequency MHz	Attenuation dB/100 m		NEXT dB		PS-NEXT dB		ACR dB at 100 m		PS-ACR dB at 100 m		ACR-F dB at 100 m		PSACR-F dB at 100 m		RL dB	
	Typ.	Cat. 6 <sub>A</sub> max.*	Typ.	Cat. 6 <sub>A</sub> min.*	Typ.	Cat. 6 <sub>A</sub> min.*	Typ.	Cat. 6 <sub>A</sub> min.*	Typ.	Cat. 6 <sub>A</sub> min.*	Typ.	Cat. 6 <sub>A</sub> min.*	Typ.	Cat. 6 <sub>A</sub> min.*	Typ.	Cat. 6 <sub>A</sub> min.*
1	1.9	2.1	95	75.3	92	72.3	93	73.2	90	70.2	91	68	88	65	26	20
10	5.2	5.9	90	60.3	87	57.3	85	54.4	82	51.4	96	48	93	45	35.9	25
100	17.7	19.1	75	45.3	72	42.3	57	26.2	54	23.2	90	28	87	25	37.2	20.1
200	26.4	27.6	68	40.8	65	37.8	42	13.2	39	10.2	78	22	75	19	33.1	18
250	29.9	31.1	66	39.3	63	36.3	36	8.3	33	5.3	75	20	72	17	30.5	17.3
300	31.9	34.3	65	38.1	62	35.1	33	3.9	30	0.9	72	18.5	69	15.5	29.9	17.3
450	38.9	42.7	63	35.5	60	32.5	24	-7.2	21	-10.2	69	14.9	66	11.9	28.9	17.3
500	41.2	45.3	61	34.8	58	31.8	20	-10.4	17	-13.4	66	14	63	11	28.3	17.3
600	46.2	-	57	-	54	-	11	-	8	-	60	-	57	-	27.2	-
700	51.4	-	54	-	51	-	3	-	0	-	56	-	53	-	26.2	-

\* EN 50288-10-1 (2013)/EN 50288-5-1 (2004)/IEC 61156-5 (2009)

### Electrical characteristics at 20°C

Direct current resistance	Max.	82 Ω/km
Insulation resistance	Min.	5 GΩ x km
Mutual capacitance	Approx.	42 pF/m
Capacitive coupling (e)	Approx.	1100 pF/km
Velocity of propagation (c)	Approx.	0.80
Propagation delay	Approx.	420 ns/100 m
Skew at 100 MHz	Approx.	7 ns/100 m
Charact. impedance	at 100 MHz	100 ± 5 Ω
Testing voltage U <sub>eff</sub>		1000 V
Operating voltage	Max.	125 V

### Thermal properties

For fixed installation	-20 °C up to +60 °C
For mobile operation	0°C up to +50°C

### Chemical characteristics

Free of hazardous substances according to RoHS 2011/65/EU

### Cable printing for 4 P

KERPEN DATACOM Made in Germany **MegaLine®** E5-70 S/F 4P H  
"CPR Class" "DoP no." "Batch number" "Metre marking"

### Certificates and approvals

Link performance: KERPEN DATACOM **MegaLine®** systems  
and other commercially available connector systems  
Test certificates: according to DIN 55350-18-4.2.1 or EN 10204  
Compliant with LVD (2014/35/EU): **CE**  
Compliant with Construction Products Regulation  
(EU/305/2011): **CE**

Dimensions	Outer Ø approx.	Weight approx.	Copper sales factor*	CPR Class	DoP no.	Sheath colour	Order no.
	mm	kg/km	kg/km				
4P	7.4	55	26	D <sub>ca</sub> s2 d2 a1	CDESK0000005	◆ Colza yellow	LKD7KS60024xxxx
2 x 4P	7.5 x 15.2	112	52	D <sub>ca</sub> s2 d2 a1	CDESK0000006	◆ Colza yellow	LKD7KS60025xxxx

Packaging: xxxx

Standard length: 0100 = 1000 m 0050 = 500 m 0000 = general

\* See page 17: Definition of copper sales factor

# MegaLine® E5-70 F/F

Category 6<sub>A</sub>

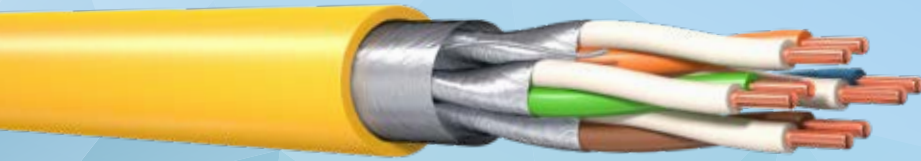

Types KS-02YS(ST)H 4x2xAWG 23/1 PIMF  
KS-02YS(ST)H 2x(4x2xAWG 23/1 PIMF)

## Benefits

- ▶ Better than category 6<sub>A</sub>
- ▶ Bandwidth 700 MHz
- ▶ good shielding characteristics
- ▶ RoHS and REACH conformity

## Construction for 4P

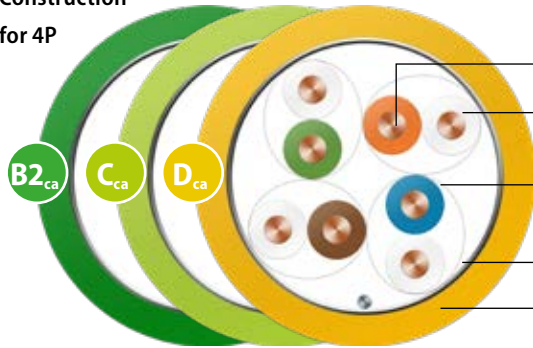

<b>Conductor</b>	Bare copper wire, AWG 23/1
<b>Insulation</b>	Foam PE, core Ø: Nominal value 1.24 mm
<b>Twisting element</b>	Pair
<b>Individual shielding</b>	Aluminium-bonded polyester foil, metal on the outside (PIMF)
<b>Twisting</b>	4 pairs
<b>Overall shielding</b>	Aluminium-bonded polyester foil, metal on the inside and copper supplementary cable
<b>Outer sheath</b>	halogen-free, flame-retardant compound

## Fire behaviour

Flame retardancy	according to IEC 60332-3-24
Halogen free	according to IEC 60754-1/2
Smoke density	according to IEC 61034-1/2
Acidity	according to EN 60754-2
Fire load (reference value)	0.60 MJ/m (Sx), 1.2 MJ/m (Dx)
EU Construction Products Regulation	according to EN 50575/EN 50399

## Performance

Better than category 6<sub>A</sub>, according to EN 50288 and IEC 61156, excellent NEXT, good shielding characteristics (shielding in pairs or overall shielding), low skew, bandwidth (typical): 700 MHz

## Applications

Installation cable for use in structured building cabling according to ISO/IEC 11801 and EN 50173 (3rd edition). Ideal for all applications of Classes D to E<sub>A</sub> up to 10 GbE according to IEEE 802.3an, cable sharing, VoIP, PoE/PoE+/4PPoE.

## Mechanical characteristics

Bending radius	During installation	8 x outer diameter (min.)
	After installation	4 x outer diameter (min.)
Tensile strength (max.)		110 N (Sx), 220 N (Dx)
Crush strength		1000 N/100 mm
Impact strength (number of shocks)		10

## Electromagnetic behaviour

Coupling resistance at 10 MHz (nom.)	50 mΩ/m
Screen attenuation (nom.)	60 dB
Coupling attenuation (nom.)	70 dB
Separating class according to EN 50174-2	c

## Security (fire behaviour)

<b>S</b>	1 IEC 60332-2-2	2 IEC-60332-1-2 E <sub>ca</sub> /D <sub>ca</sub>	3 IEC-60332-3-24 E <sub>ca</sub> /D <sub>ca</sub>	4 EFP Grade 1 C <sub>ca</sub>	5 EFP Grade 2 B2 <sub>ca</sub>
----------	--------------------	--	---	-------------------------------------	--------------------------------------

## Performance (cabling class, bandwidth)

<b>P</b>	1 > Class E > 250 MHz	2 > Class E <sub>A</sub> > 500 MHz	3 > Class F > 600 MHz	4 > Class F <sub>A</sub> > 1000 MHz	5 > Class F <sub>A</sub> + > 1200 MHz
----------	-----------------------------	--	-----------------------------	---	---

## Application (Ethernet, TV)

<b>A</b>	1 > 100 MbE	2 > 1 GbE	3 Up to 10 GbE	4 > 10 GbE	5 > 10 GbE TV
----------	----------------	--------------	-------------------	---------------	------------------

## Construction (conductor dimension, tensile strength)

<b>C</b>	1 AWG 27	2 AWG 26/25	3 AWG 24	4 AWG 23	5 AWG 22
----------	-------------	----------------	-------------	-------------	-------------

## EMC (coupling attenuation)

<b>E</b>	1 > 40 dB	2 > 50 dB	3 > 60 dB	4 > 70 dB	5 > 80 dB
----------	--------------	--------------	--------------	--------------	--------------

### Electrical characteristics (HF) at 20°C

Frequency MHz	Attenuation dB/100 m		NEXT dB		PS-NEXT dB		ACR dB at 100 m		PS-ACR dB at 100 m		ACR-F dB at 100 m		PSACR-F dB at 100 m		RL dB	
	Typ.	Cat. 6 <sub>A</sub> max.*	Typ.	Cat. 6 <sub>A</sub> min.*	Typ.	Cat. 6 <sub>A</sub> min.*	Typ.	Cat. 6 <sub>A</sub> min.*	Typ.	Cat. 6 <sub>A</sub> min.*	Typ.	Cat. 6 <sub>A</sub> min.*	Typ.	Cat. 6 <sub>A</sub> min.*	Typ.	Cat. 6 <sub>A</sub> min.*
1	1.9	2.1	95	75.3	92	72.3	93	73.2	90	70.2	91	68	88	65	25.1	-
10	5.2	5.9	90	60.3	87	57.3	85	54.4	82	51.4	96	48	93	45	35.2	25
100	17.7	19.1	75	45.3	72	42.3	57	26.2	54	23.2	90	28	87	25	37.2	20.1
200	26.4	27.6	68	40.8	65	37.8	42	13.2	39	10.2	78	22	75	19	31.1	18
250	29.9	31.1	66	39.3	63	36.3	36	8.3	33	5.3	75	20	72	17	29.5	17.3
300	31.9	34.3	65	38.1	62	35.1	33	3.9	30	0.9	72	18.5	69	15.5	28.3	17.3
450	38.9	42.7	63	35.5	60	32.5	24	-7.2	21	-10.2	69	14.9	66	11.9	26.7	17.3
500	41.2	45.3	61	34.8	58	31.8	20	-10.4	17	-13.4	66	14	63	11	26.3	17.3
600	46.2	-	57	-	54	-	11	-	8	-	60	-	57	-	25.8	-
700	51.4	-	54	-	51	-	3	-	0	-	56	-	53	-	-	-

\* EN 50288-10-1 (2013)/EN 50288-5-1 (2004)/IEC 61156-5 (2009)

### Electrical characteristics at 20°C

Direct current resistance	Max.	82 Ω/km
Insulation resistance	Min.	5 GΩ x km
Mutual capacitance	Approx.	42 pF/m
Capacitive coupling (e)	Approx.	1100 pF/km
Signal tempo (c)	Approx.	0.80
Propagation delay	Approx.	417 ns/100 m
Skew at 100 MHz	Approx.	7 ns/100 m
Charact. impedance	at 100 MHz	100 ± 5 Ω
Testing voltage U <sub>eff</sub>		1000 V
Operating voltage	Max.	125 V

### Thermal properties

For fixed installation	-20 °C up to +60 °C
For mobile operation	0°C up to +50°C

### Chemical characteristics

Free of hazardous substances according to RoHS 2011/65/EU

### Cable printing for 4P

KERPEN DATACOM Made in Germany **MegaLine®** E5-70 F/F 4P H  
"CPR Class" "DoP no." Made in Germany "Batch number" "Metre marking"

### Certificates and approvals

Link performance: KERPEN DATACOM **MegaLine®** systems  
and other commercially available connector systems  
Test certificates: according to DIN 55350-18-4.2.1 or EN 10204  
Compliant with LVD (2014/35/EU): **CE**  
Compliant with Construction Products Regulation  
(EU/305/2011): **CE**

Dimensions	Outer Ø approx.	Weight approx.	Copper sales factor*	CPR Class	DoP no.	Sheath colour	Order no.
	mm	kg/km	kg/km				
4P	7.5	58	23.5	D <sub>ca</sub> s2 d2 a1	CDESK0000003	◆ Colza yellow	LKD7KS60022xxxx
2 x 4P	7.5 x 15.2	120	47	D <sub>ca</sub> s2 d2 a1	CDESK0000004	◆ Colza yellow	LKD7KS60023xxxx
4P	7.5	58	23.5	C <sub>ca</sub> s1 d1 a1	CDESK0000042	◆ Lime green	LKD7KS6C022xxxx
4P	7.5	58	23.5	B2 <sub>ca</sub> s1a d1 a1	CDESK0000041	◆ Yellow green	LKD7KS6B022xxxx

Packaging: xxxx

Standard length: 0100 = 1000 m 0050 = 500 m 0000 = general

\* See page 17: Definition of copper sales factor

# MegaLine® E5-60 U/F

Category 6<sub>A</sub>

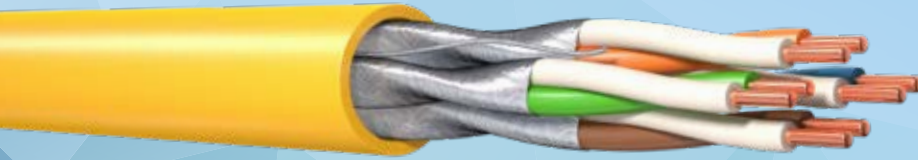

Type KS-02YSH 4x2xAWG 23/1 PIMF

## Benefits

- ▶ Better than category 6<sub>A</sub>
- ▶ Bandwidth 600 MHz
- ▶ good shielding characteristics
- ▶ RoHS and REACH conformity

## Construction for 4P

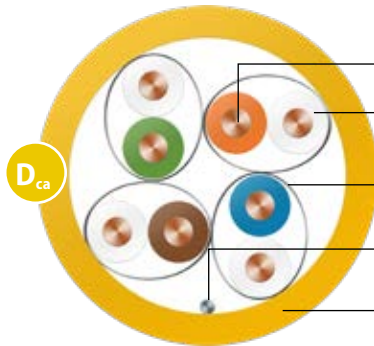

<b>Conductor</b>	Bare copper wire, AWG 23/1
<b>Insulation</b>	Foam PE, core Ø: Nominal value 1.4 mm
<b>Twisting element</b>	Pair
<b>Individual shielding</b>	Aluminium-bonded polyester foil, metal on the outside (PIMF)
<b>Twisting</b>	4 pairs
<b>Taping</b>	Plastic foil (optional) and tinned supplementary copper wire AWG24/1
<b>Outer sheath</b>	halogen-free, flame-retardant compound

## Fire behaviour

Flame retardancy	according to IEC 60332-3-24
Halogen free	according to IEC 60754-1/2
Smoke density	according to IEC 61034-1/2
Acidity	according to EN 60754-2
Fire load (reference value)	0.60 MJ/m (Sx),
EU Construction Products Regulation	according to EN 50575 / EN 50399

## Performance

Better than category 6<sub>A</sub>, according to EN 50288 and IEC 61156, excellent NEXT, good shielding characteristics (shielding in pairs or overall shielding), low skew, bandwidth (typical): 600 MHz

## Applications

Installation cable for use in structured building cabling according to ISO/IEC 11801 and EN 50173 (3rd edition). Ideal for all applications of Classes D to E<sub>A</sub> up to 10 GbE according to IEEE 802.3an, cable sharing, VoIP, PoE/PoE+/4PPoE.

## Mechanical characteristics

Bending radius	During installation	8 x outer diameter (min.)
	After installation	4 x outer diameter (min.)
Tensile strength (max.)		110 N (Sx)
Crush strength		1000 N/100 mm
Impact strength (number of shocks)		10

## Electromagnetic behaviour

Coupling resistance at 10 MHz (nom.)	50 mΩ/m
Screen attenuation (nom.)	55 dB
Coupling attenuation (nom.)	65 dB
Separating class according to EN 50174-2	c

## Security (fire behaviour)

S	1 IEC 60332-2-2	2 IEC-60332-1-2 E <sub>ca</sub> /D <sub>ca</sub>	3 IEC-60332-3-24 E <sub>ca</sub> /D <sub>ca</sub>	4 EFP Grade 1 C <sub>ca</sub>	5 EFP Grade 2 B2 <sub>ca</sub>
---	--------------------	--	---	-------------------------------------	--------------------------------------

## Performance (cabling class, bandwidth)

P	1 > Class E > 250 MHz	2 > Class E <sub>A</sub> > 500 MHz	3 > Class F > 600 MHz	4 > Class F <sub>A</sub> > 1000 MHz	5 > Class F <sub>A</sub> + > 1200 MHz
---	-----------------------------	--	-----------------------------	---	---

## Application (Ethernet, TV)

A	1 > 100 MbE	2 > 1 GbE	3 Up to 10 GbE	4 > 10 GbE	5 > 10 GbE TV
---	----------------	--------------	-------------------	---------------	------------------

## Construction (conductor dimension, tensile strength)

C	1 AWG 27	2 AWG 26/25	3 AWG 24	4 AWG 23	5 AWG 22
---	-------------	----------------	-------------	-------------	-------------

## EMC (coupling attenuation)

E	1 > 40 dB	2 > 50 dB	3 > 60 dB	4 > 70 dB	5 > 80 dB
---	--------------	--------------	--------------	--------------	--------------



### Electrical characteristics (HF) at 20°C

Frequency MHz	Attenuation dB/100 m		NEXT dB		PS-NEXT dB		ACR dB at 100 m		PS-ACR dB at 100 m		ACR-F dB at 100 m		PSACR-F dB at 100 m		RL dB	
	Typ.	Cat. 6 <sub>A</sub> max.*	Typ.	Cat. 6 <sub>A</sub> min.*	Typ.	Cat. 6 <sub>A</sub> min.*	Typ.	Cat. 6 <sub>A</sub> min.*	Typ.	Cat. 6 <sub>A</sub> min.*	Typ.	Cat. 6 <sub>A</sub> min.*	Typ.	Cat. 6 <sub>A</sub> min.*	Typ.	Cat. 6 <sub>A</sub> min.*
1	1.9	2.1	95	75.3	92	72.3	93	73.2	90	70.2	91	68	88	65	25.1	–
10	5.2	5.9	90	60.3	87	57.3	85	54.4	82	51.4	96	48	93	45	35.2	25
100	17.7	19.1	75	45.3	72	42.3	57	26.2	54	23.2	90	28	87	25	37.2	20.1
200	26.4	27.6	68	40.8	65	37.8	42	13.2	39	10.2	78	22	75	19	31.1	18
250	29.9	31.1	66	39.3	63	36.3	36	8.3	33	5.3	75	20	72	17	29.5	17.3
300	31.9	34.3	65	38.1	62	35.1	33	3.9	30	0.9	72	18.5	69	15.5	28.3	17.3
450	38.9	42.7	63	35.5	60	32.5	24	-7.2	21	-10.2	69	14.9	66	11.9	26.7	17.3
500	41.2	45.3	61	34.8	58	31.8	20	-10.4	17	-13.4	66	14	63	11	26.3	17.3
600	46.2	–	57	–	54	–	11	–	8	–	60	–	57	–	25.8	–

\* EN 50288-10-1 (2013)/EN 50288-5-1 (2004)/IEC 61156-5 (2009)

### Electrical characteristics at 20°C

Direct current resistance	Max.	82 Ω/km
Insulation resistance	Min.	5 GΩ x km
Mutual capacitance	Approx.	42 pF/m
Capacitive coupling (e)	Approx.	1100 pF/km
Velocity of propagation (c)	Approx.	0.80
Propagation delay	Approx.	420 ns/100 m
Skew at 100 MHz	Approx.	7 ns/100 m
Charact. impedance	at 100 MHz	100 ± 5 Ω
Testing voltage U <sub>eff</sub>		1000 V
Operating voltage	Max.	125 V

### Thermal properties

For fixed installation	-20 °C up to +60 °C
For mobile operation	0°C up to +50°C

### Chemical characteristics

Free of hazardous substances according to RoHS 2011/65/EU

### Cable printing for 4P

KERPEN DATACOM Made in Germany **MegaLine®** E5-60 U/F 4P H  
"CPR Class" "DoP no." "Batch number" "Metre marking"

### Certificates and approvals

Link performance: KERPEN DATACOM **MegaLine®** systems  
and other commercially available connector systems

Test certificates: according to DIN 55350-18-4.2.1 or EN 10204

Compliant with LVD (2014/35/EU): **CE**

Compliant with Construction Products Regulation  
(EU/305/2011): **CE**

Dimensions	Outer Ø approx.	Weight approx.	Copper sales factor*	CPR Class	Sheath colour	Order no.
	mm	kg/km	kg/km			
4P	7.2	53	23.5	D <sub>ca</sub> s2 d2 a1	◆ Colza yellow	LKD7KS600350000
8P	7.4 x 15.0	112	47	D <sub>ca</sub> s2 d2 a1	◆ Colza yellow	LKD7KS600360000
4P	7.0	50	23.5	C <sub>ca</sub> s1 d1 a1	◆ Lime green	LKD7KS6C0350000
4P	7.2	53	23.5	B2 <sub>ca</sub> s1a d1 a1	◆ Yellow green	LKD7KS6B0350000

# MegaLine® E2-45 U/F

## Category 6

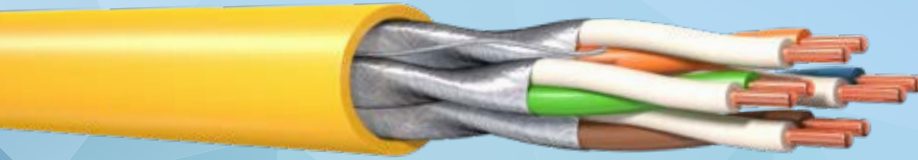

Types KS-02YSH 4x2xAWG 23/1 PIMF  
KS-02YSH 2x(4x2xAWG 23/1 PIMF)

### Benefits

- ▶ Better than category 6
- ▶ Bandwidth 450 MHz
- ▶ RoHS and REACH conformity

### Construction for 4P

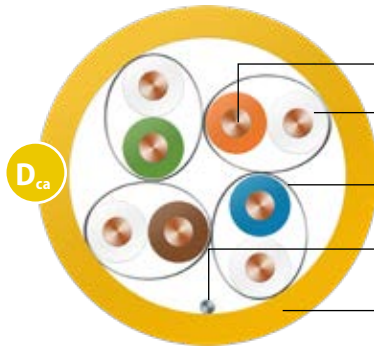

<b>Conductor</b>	Bare copper wire, AWG 23/1
<b>Insulation</b>	Foam PE, core Ø: Nominal value 1.24 mm
<b>Twisting element</b>	Pair
<b>Individual shielding</b>	Aluminium-bonded polyester foil, metal on the outside (PIMF)
<b>Twisting</b>	4 pairs
<b>Taping</b>	plastic foil (optional) and supplementary copper wire AWG24/1
<b>Outer sheath</b>	halogen-free, flame-retardant compound

<b>Fire behaviour</b>	
Flame retardancy	according to IEC 60332-1-2
Halogen free	according to IEC 60754-1/2
Smoke density	according to IEC 61034-1/2
Acidity	according to EN 60754-2
Fire load (reference value)	0.60 MJ/m (Sx), 1.2 MJ/m (Dx)
EU Construction Products Regulation	according to EN 50575 / EN 50399

<b>Performance</b>	
Better than category 6 according to EN 50288 and IEC 61156, Excellent NEXT, low skew, bandwidth (typical): 450 MHz	

<b>Applications</b>	
Installation cable for use in structured building cabling according to ISO/IEC 11801 and EN 50173 (3rd edition). Ideal for all applications of Classes D to E up to 1 GbE according to IEEE 802.3ab, cable sharing, VoIP, PoE/PoE+/4PPoE.	

<b>Mechanical characteristics</b>	
Bending radius	During installation 8 x outer diameter (min.) After installation 4 x outer diameter (min.)
Tensile strength (max.)	110 N (Sx), 220 N (Dx)
Crush strength	1000 N/100 mm
Impact strength (number of shocks)	10

<b>Electromagnetic behaviour</b>	
Coupling resistance at 10 MHz (nom.)	80 mΩ/m
Screen attenuation (nom.)	50 dB
Coupling attenuation (nom.)	60 dB
Separating class according to EN 50174-2	b

### Security (fire behaviour)

	<b>1</b>	<b>2</b>	<b>3</b>	<b>4</b>	<b>5</b>
<b>S</b>	IEC 60332-2-2	IEC-60332-1-2	IEC-60332-3-24	EFP Grade 1	EFP Grade 2
		E <sub>ca</sub> /D <sub>ca</sub>	E <sub>ca</sub> /D <sub>ca</sub>	C <sub>ca</sub>	B2 <sub>ca</sub>

### Performance (cabling class, bandwidth)

	<b>1</b>	<b>2</b>	<b>3</b>	<b>4</b>	<b>5</b>
<b>P</b>	> Class E > 250 MHz	> Class E <sub>A</sub> > 500 MHz	> Class F > 600 MHz	> Class F <sub>A</sub> > 1000 MHz	> Class F <sub>A+</sub> > 1200 MHz

### Application (Ethernet, TV)

	<b>1</b>	<b>2</b>	<b>3</b>	<b>4</b>	<b>5</b>
<b>A</b>	> 100 MbE	> 1 GbE	Up to 10 GbE	> 10 GbE	> 10 GbE TV

### Construction (conductor dimension, tensile strength)

	<b>1</b>	<b>2</b>	<b>3</b>	<b>4</b>	<b>5</b>
<b>C</b>	AWG 27	AWG 26/25	AWG 24	AWG 23	AWG 22

### EMC (coupling attenuation)

	<b>1</b>	<b>2</b>	<b>3</b>	<b>4</b>	<b>5</b>
<b>E</b>	> 40 dB	> 50 dB	> 60 dB	> 70 dB	> 80 dB

### Electrical characteristics (HF) at 20°C

Frequency MHz	Attenuation dB/100 m		NEXT dB		PS-NEXT dB		ACR dB at 100 m		PS-ACR dB at 100 m		EL-FEXT dB at 100 m		PS-ELFEXT dB at 100 m		RL dB	
	Typ.	Cat. 6 max.*	Typ.	Cat. 6 min.*	Typ.	Cat. 6 min.*	Typ.	Cat. 6 min.*	Typ.	Cat. 6 min.*	Typ.	Cat. 6 min.*	Typ.	Cat. 6 min.*	Typ.	Cat. 6 min.*
1	1.9	2.1	95	66	92	64	93	64	90	62	88	66	85	64	25.4	–
4	3.2	3.8	95	65	92	63	92	61	89	59	89	58	86	55	28.6	23
10	5.2	6	90	59	87	57	85	53	82	51	92	50	89	47	33.5	25
16	7	7.6	90	56	87	54	83	49	80	47	98	46	95	43	35.6	25
31.25	9.9	10.7	85	52	82	50	75	41	72	39	98	40	95	37	37	23.6
62.5	13.5	15.5	80	47	77	45	66	32	63	30	95	34	92	31	35.9	21.5
100	17.9	19.9	75	44	72	42	57	24	54	22	88	30	85	27	34.3	20.1
155	22.5	25.3	72	41	69	39	49	16	46	14	81	26	78	23	32.2	18.8
200	26.9	29.1	68	40	65	38	41	11	38	9	75	24	72	21	31.3	18
250	30.4	33	66	38	63	36	36	5	33	3	72	22	69	19	29.2	17.3
300	33.1	–	65	–	62	–	32	–	29	–	69	–	66	–	28	–
450	39.3	–	63	–	60	–	24	–	21	–	64	–	61	–	27	–

\* EN 50288-5-1(2014)/IEC 61156-5 (2009)

### Electrical characteristics at 20°C

Direct current resistance	Max.	82 Ω/km
Insulation resistance	Min.	5 GΩ x km
Mutual capacitance	Approx.	42 pF/m
Capacitive coupling (e)	Approx.	1100 pF/km
Velocity of propagation (c)	Approx.	0.80
Propagation delay	Approx.	420 ns/100 m
Skew at 100 MHz	Approx.	7 ns/100 m
Charact. impedance	at 100 MHz	100 ± 5 Ω
Testing voltage U <sub>eff</sub>		1000 V
Operating voltage	Max.	125 V

### Thermal properties

For fixed installation	-20 °C up to +60 °C
For mobile operation	0°C up to +50°C

### Chemical characteristics

Free of hazardous substances according to RoHS 2011/65/EU

### Cable printing for 4 P

KERPEN DATACOM Made in Germany **MegaLine®** E2-45 U/F 4P H  
"CPR Class" "DoP no." "Batch number" "Metre marking"

### Certificates and approvals

Link performance: KERPEN DATACOM **MegaLine®** systems  
and other commercially available connector systems  
Test certificates: according to DIN 55350-18-4.2.1 or EN 10204  
Compliant with LVD (2014/35/EU): **CE**  
Compliant with Construction Products Regulation  
(EU/305/2011): **CE**

Dimensions	Outer Ø approx.	Weight approx.	Copper sales factor*	CPR Class	DoP no.	Sheath colour	Order no.
	mm	kg/km	kg/km				
4P	7.4	55	23.5	D <sub>ca</sub> s2 d2 a1	CDESK0000001	◆ Colza yellow	LKD7KS60005xxxx
2 x 4P	7.4 x 15.0	114	47	D <sub>ca</sub> s2 d2 a1	CDESK0000002	◆ Colza yellow	LKD7KS60006xxxx

Packaging: xxxx

Standard length: 0100 = 1000 m 0050 = 500 m 0000 = general

\* See page 17: Definition of copper sales factor

# MegaLine® E2-30 U/U

## Category 6



Type KS-2YH 4x2xAWG 23/1

### Benefits

- ▶ Better than category 6
- ▶ Bandwidth 300 MHz
- ▶ RoHS and REACH conformity

### Construction for 4P

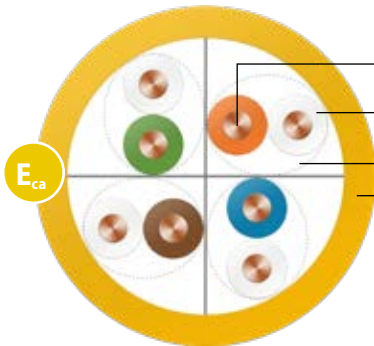

Conductor	Bare copper wire, AWG 23/1
Insulation	PE
Twisting element	Pair
Twisting	4 pairs separated by a cross element
Outer sheath	halogen-free, flame-retardant compound

### Fire behaviour

Flame retardancy	according to IEC 60332-1-2
Halogen free	according to IEC 60754-1/2
Smoke density	according to IEC 61034-1/2
Acidity	according to EN 60754-2
Fire load (reference value)	0.65 MJ/m
EU Construction Products Regulation	according to EN 50575 / EN 50399

### Performance

Better than Category 6 according to EN 50288 and IEC 61156  
Bandwidth (typical): 300 MHz

### Applications

Installation cable for use in structured building cabling according to ISO/IEC 11801 and EN 50173 (3rd edition).  
Ideal for all applications of Classes D to E up to 1 GbE according to IEEE 802.3ab, VoIP, PoE/PoE+/4PPoE.

### Mechanical characteristics

Bending radius	During installation	8 x outer diameter (min.)
	After installation	4 x outer diameter (min.)
Tensile strength (max.)		110 N
Crush strength		1000 N/100 mm
Impact strength (number of shocks)		10

### Electromagnetic behaviour

Coupling attenuation (nom.)	45 dB
Separating class according to EN 50174-2	b

### Security (fire behaviour)

S	1 IEC 60332-2-2	2 IEC-60332-1-2	3 IEC-60332-3-24	4 EFP Grade 1	5 EFP Grade 2
		E <sub>ca</sub> /D <sub>ca</sub>	E <sub>ca</sub> /D <sub>ca</sub>	C <sub>ca</sub>	B2 <sub>ca</sub>

### Performance (cabling class, bandwidth)

P	1 > Class E > 250 MHz	2 > Class E <sub>A</sub> > 500 MHz	3 > Class F > 600 MHz	4 > Class F <sub>A</sub> > 1000 MHz	5 > Class F <sub>A</sub> + > 1200 MHz
---	-----------------------------	--	-----------------------------	---	---

### Application (Ethernet, TV)

A	1 > 100 MbE	2 > 1 GbE	3 Up to 10 GbE	4 > 10 GbE	5 > 10 GbE TV
---	----------------	--------------	-------------------	---------------	------------------

### Construction (conductor dimension, tensile strength)

C	1 AWG 27	2 AWG 26/25	3 AWG 24	4 AWG 23	5 AWG 22
---	-------------	----------------	-------------	-------------	-------------

### EMC (coupling attenuation)

E	1 > 40 dB	2 > 50 dB	3 > 60 dB	4 > 70 dB	5 > 80 dB
---	--------------	--------------	--------------	--------------	--------------

### Electrical characteristics (HF) at 20°C

Frequency MHz	Attenuation dB/100 m		NEXT dB		PS-NEXT dB		ACR dB at 100 m		PS-ACR dB at 100 m		EL-FEXT dB at 100 m		PS-ELFEXT dB at 100 m		RL dB	
	Typ.	Cat. 6 max.*	Typ.	Cat. 6 min.*	Typ.	Cat. 6 min.*	Typ.	Cat. 6 min.*	Typ.	Cat. 6 min.*	Typ.	Cat. 6 min.*	Typ.	Cat. 6 min.*	Typ.	Cat. 6 min.*
1	1.8	2.1	94	66	91	64	92	64	89	62	102	66	99	64	25.4	–
4	2.7	3.8	88	65	85	63	85	61	82	59	96	58	93	55	30.3	23
10	4.7	6	81	59	78	57	76	53	73	51	85	50	82	47	33.9	25
16	6.6	7.6	76	56	73	54	70	49	67	47	78	46	75	43	33.6	25
32.25	9.5	10.9	72	52	69	50	62	41	59	39	70	40	67	37	33.7	23.6
62.5	13	15.5	68	47	65	45	55	32	52	30	63	34	60	31	34.4	21.5
100	17.4	19.9	64	44	61	42	46	24	43	22	57	30	54	27	33.5	20.1
155	22	25.3	60	41	57	39	38	16	35	14	50	26	47	23	32.2	18.8
200	26.6	29.1	58	40	55	38	31	11	28	9	45	24	42	21	30.5	18
250	30.4	33	57	38	54	36	27	5	24	3	40	22	37	19	29	17.3
300	33.1	–	54	–	51	–	20	–	17	–	37	–	34	–	27	–

\* EN 50288-6-1(2014)/IEC 61156-5 (2009)

### Electrical characteristics at 20°C

Direct current resistance	Max.	78 Ω/km
Insulation resistance	Min.	5 GΩ x km
Mutual capacitance	Approx.	50 pF/m
Capacitive coupling (e)	Approx.	1100 pF/km
Velocity of propagation (c)	Approx.	0.67
Propagation delay	Approx.	528 ns/100 m
Skew at 100 MHz	Approx.	30 ns/100 m
Charact. impedance	at 100 MHz	100 ± 5 Ω
Testing voltage U <sub>eff</sub>		1000 V
Operating voltage	Max.	125 V

### Thermal properties

For fixed installation	-20 °C up to +60 °C
For mobile operation	0°C up to +50°C

### Chemical characteristics

Free of hazardous substances according to RoHS 2011/65/EU

### Cable printing

KERPEN DATACOM Made in Germany **MegaLine®** E2-30 U/U 4P H  
"CPR Class" "DoP no." "Batch number" "Metre marking"

### Certificates and approvals

Link performance: KERPEN DATACOM **MegaLine®** systems  
and other commercially available connector systems  
Test certificates: according to DIN 55350-18-4.2.1 or EN 10204  
Compliant with LVD (2014/35/EU): **CE**  
Compliant with Construction Products Regulation  
(EU/305/2011): **CE**

Dimensions	Outer Ø approx.	Weight approx.	Copper sales factor*	CPR Class	DoP no.	Sheath colour	Order no.
	mm	kg/km	kg/km				
4P	6.4	45	21	E <sub>ca</sub>	CDESK0000011	◆ Colza yellow	LKD7KS60002xxxx

Packaging: xxxx

Standard length: 0100 = 1000 m 0050 = 500 m 0000 = general

\* See page 17: Definition of copper sales factor

# MegaLine® D1-20 SF/U

## Category 5



Types KS-02YS(ST+C)H 4x2xAWG 24/1  
KS-02YS(ST+C)H 2x(4x2xAWG 24/1)

### Benefits

- ▶ Better than category 5
- ▶ Bandwidth 200 MHz
- ▶ good shielding characteristics
- ▶ RoHS and REACH conformity

### Construction for 4P

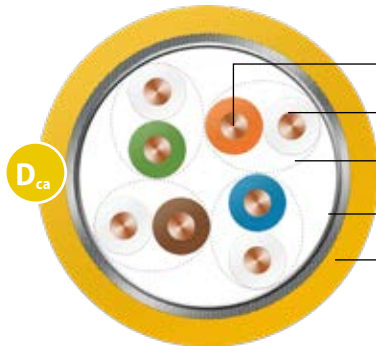

<b>Conductor</b>	Bare copper wire, AWG 24/1
<b>Insulation</b>	Foam PE, core Ø: Nominal value 1.1 mm
<b>Twisting element</b>	Pair
<b>Twisting</b>	4 pairs
<b>Overall shielding</b>	Aluminium-bonded polyester foil and Tinned copper wire braid
<b>Outer sheath</b>	halogen-free, flame-retardant compound

<b>Fire behaviour</b>	
Flame retardancy	according to IEC 60332-1-2
Halogen free	according to IEC 60754-1/2
Acidity	according to EN 60754-2
Fire load (reference value)	0.4 MJ/m (Sx), 0.81 MJ/m (Dx)
EU Construction Products Regulation	according to EN 50575/EN 50399

<b>Performance</b>	
Better than category 5 according to EN 50288 and IEC 61156, excellent shielding characteristics, Bandwidth (typical): 200 MHz	

<b>Applications</b>	
Installation cable for use in structured building cabling according to ISO/IEC 11801 and EN 50173 (3rd edition). Ideal for all applications of Class D up to 1 GbE according to IEEE 802.3ab, VoIP, PoE/PoE+/4PPoE.	

<b>Mechanical characteristics</b>	
Bending radius	During installation 8 x outer diameter (min.) After installation 4 x outer diameter (min.)
Tensile strength (max.)	85 N (Sx), 170 N (Dx)
Crush strength	1000 N/100 mm
Impact strength (number of shocks)	10

<b>Electromagnetic behaviour</b>	
Coupling resistance at 10 MHz (nom.)	10 mΩ/m
Screen attenuation (nom.)	55 dB
Coupling damping (nom.) 70 dB	
Separating class according to EN 50174-2	c

### Security (fire behaviour)

	<b>1</b>	<b>2</b>	<b>3</b>	<b>4</b>	<b>5</b>
	IEC 60332-2-2	IEC-60332-1-2	IEC-60332-3-24	EFP Grade 1	EFP Grade 2
<b>S</b>		E <sub>ca</sub> /D <sub>ca</sub>	E <sub>ca</sub> /D <sub>ca</sub>	C <sub>ca</sub>	B2 <sub>ca</sub>

### Performance (cabling class, bandwidth)

	<b>1</b>	<b>2</b>	<b>3</b>	<b>4</b>	<b>5</b>
	> Class E	> Class E <sub>A</sub>	> Class F	> Class F <sub>A</sub>	> Class F <sub>A+</sub>
	> 250 MHz	> 500 MHz	> 600 MHz	> 1000 MHz	> 1200 MHz
<b>P</b>					

### Application (Ethernet, TV)

	<b>1</b>	<b>2</b>	<b>3</b>	<b>4</b>	<b>5</b>
	> 100 MbE	> 1 GbE	Up to 10 GbE	> 10 GbE	> 10 GbE TV
<b>A</b>					

### Construction (conductor dimension, tensile strength)

	<b>1</b>	<b>2</b>	<b>3</b>	<b>4</b>	<b>5</b>
	AWG 27	AWG 26/25	AWG 24	AWG 23	AWG 22
<b>C</b>					

### EMC (coupling attenuation)

	<b>1</b>	<b>2</b>	<b>3</b>	<b>4</b>	<b>5</b>
	> 40 dB	> 50 dB	> 60 dB	> 70 dB	> 80 dB
<b>E</b>					

### Electrical characteristics (HF) at 20°C

Frequency MHz	Attenuation dB/100 m		NEXT dB		PS-NEXT dB		ACR dB at 100 m		PS-ACR dB at 100 m		EL-FEXT dB at 100 m		PS-ELFEXT dB at 100 m		RL dB	
	Typ.	Cat. 5 max.*	Typ.	Cat. 5 min.*	Typ.	Cat. 5 min.*	Typ.	Cat. 5 min.*	Typ.	Cat. 5 min.*	Typ.	Cat. 5 min.*	Typ.	Cat. 5 min.*	Typ.	Cat. 5 min.*
1	2	2.1	75	65	72	62	73	63	70	60	89	64	86	61	24.8	-
4	3.1	4	69	56	66	53	66	52	63	49	84	52	81	49	28.6	23
10	5.1	6.3	62	50	59	47	57	44	54	41	76	44	73	41	33.3	25
16	7	8	58	47	55	44	51	39	48	36	70	40	67	37	34.3	25
31.25	9.7	11.4	53	43	50	40	44	31	41	28	63	34	60	31	33.9	23.6
62.5	13.2	16.5	49	38	46	35	36	22	33	19	58	28	55	25	31.3	21.5
100	17.6	21.3	45	35	42	32	28	14	25	11	52	24	49	21	27.7	20.1
155	22.3	-	42	-	39	-	20	-	17	-	49	-	46	-	24.7	-
200	26.5	-	40	-	37	-	14	-	11	-	45	-	42	-	22.4	-

\* EN 50288-2-1(2014)/IEC 61156-5 (2009)

### Electrical characteristics at 20°C

Direct current resistance	Max.	95 Ω/km
Insulation resistance	Min.	5 GΩ x km
Mutual capacitance	Approx.	45 pF/m
Capacitive coupling (e)	Approx.	1100 pF/km
Velocity of propagation (c)	Approx.	0.75
Propagation delay	Approx.	440 ns/100 m
Skew at 100 MHz	Approx.	15 ns/100 m
Charact. impedance	at 100 MHz	100 ± 5 Ω
Testing voltage U <sub>eff</sub>		1000 V
Operating voltage	Max.	125 V

### Thermal properties

For fixed installation	-20 °C up to +60 °C
For mobile operation	0°C up to +50°C

### Chemical characteristics

Free of hazardous substances according to RoHS 2011/65/EU

### Cable printing for 4P

KERPEN DATACOM Made in Germany **MegaLine®** D1-20 SF/U 4P  
H "CPR Class" "DoP no." "Batch number" "Metre marking"

### Certificates and approvals

Link performance: KERPEN DATACOM **MegaLine®** systems  
and other commercially available connector systems  
Test certificates: according to DIN 55350-18-4.2.1 or EN 10204  
Compliant with LVD (2014/35/EU): **CE**  
Compliant with Construction Products Regulation  
(EU/305/2011): **CE**

Dimensions	Outer Ø approx.	Weight approx.	Copper sales factor*	CPR Class	DoP no.	Sheath colour	Order no.
	mm	kg/km	kg/km				
4P	6.0	42	26	D <sub>ca</sub> s2 d2 a1	CDESK0000020	◆ Colza yellow	LKD7KS50005xxxx
2 x 4P	6.0 x 12.5	86	52	D <sub>ca</sub> s2 d2 a1	CDESK0000021	◆ Colza yellow	LKD7KS50006xxxx

Packaging: xxxx

Standard length: 0100 = 1000 m 0050 = 500 m 0000 = general

\* See page 17: Definition of copper sales factor

# MegaLine® Pro 1500

Category 7<sub>A</sub>



Types KS-02YSCH 4x2x0,62 mm/~AWG 22/1 PIMF  
KS-02YSCH 2x(4x2x0,62 mm/~AWG 22/1 PIMF)

## Benefits

- ▶ Better than category 7<sub>A</sub>
- ▶ Bandwidth 1500 MHz
- ▶ RoHS and REACH conformity

## Construction for 4P

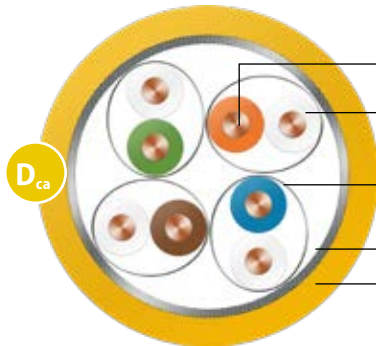

<b>Conductor</b>	Bare copper wire, 0.62 mm~AWG 22/1
<b>Insulation</b>	Foam PE, coreØ: Nominal value 1.6 mm
<b>Twisting element</b>	Pair
<b>Individual shielding</b>	Aluminium-bonded polyester foil, metal on the outside (PiMF)
<b>Twisting</b>	4 pairs
<b>Overall shielding</b>	Tinned copper wire braid
<b>Outer sheath</b>	halogen-free, flame-retardant compound

## Fire behaviour

Flame retardancy	according to IEC 60332-3-24
Halogen free	according to IEC 60754-1/2
Smoke density	according to IEC 61034-1/2
Fire load (reference value)	0.65 MJ/m (Sx), 1.33 MJ/m (Dx)
Acidity	according to EN 60754-2
EU Construction Products Regulation	according to EN 50575 / EN 50399

## Performance

Better than Category 7<sub>A</sub>, according to EN 50288 and IEC 61156  
Excellent NEXT, low attenuation, excellent shielding characteristics (shielding in pairs and overall shielding), low skew, bandwidth (typical): 1500 MHz

## Applications

Installation cable for use in structured building cabling according to ISO/IEC 11801 and EN 50173 (3rd edition). Ideal for all applications of Classes D to F<sub>A</sub>, multimedia (video, data, voice) >10 GbE according to IEEE 802.3an, 25G in line with TR-11801-9905 in channel links up to 50m, cable sharing, VoIP, PoE/PoE+/4PPoE.

## Mechanical characteristics

Bending radius	During installation	8 x outer diameter (min.)
	After installation	4 x outer diameter (min.)
Tensile strength (max.)		110 N (Sx), 220 N (Dx)
Crush strength		1000 N/100 mm
Impact strength (number of shocks)		10

## Electromagnetic behaviour

Coupling resistance at 10 MHz (nom.)	5 mΩ/m
Screen attenuation (nom.)	70 dB
Coupling attenuation (nom.)	85 dB
Separating class according to EN 50174-2	d

## Security (fire behaviour)

S	1 IEC 60332-2-2	2 IEC-60332-1-2	3 IEC-60332-3-24	4 EFP Grade 1	5 EFP Grade 2
		E <sub>ca</sub> /D <sub>ca</sub>	E <sub>ca</sub> /D <sub>ca</sub>	C <sub>ca</sub>	B2 <sub>ca</sub>

## Performance (cabling class, bandwidth)

P	1 > Class E > 250 MHz	2 > Class E <sub>A</sub> > 500 MHz	3 > Class F > 600 MHz	4 > Class F <sub>A</sub> > 1000 MHz	5 > Class F <sub>A</sub> + > 1200 MHz
---	-----------------------------	--	-----------------------------	---	---

## Application (Ethernet, TV)

A	1 > 100 MbE	2 > 1 GbE	3 Up to 10 GbE	4 > 10 GbE	5 > 10 GbE TV
---	----------------	--------------	-------------------	---------------	------------------

## Construction (conductor dimension, tensile strength)

C	1 AWG 27	2 AWG 26/25	3 AWG 24	4 AWG 23	5 AWG 22
---	-------------	----------------	-------------	-------------	-------------

## EMC (coupling attenuation)

E	1 > 40 dB	2 > 50 dB	3 > 60 dB	4 > 70 dB	5 > 80 dB
---	--------------	--------------	--------------	--------------	--------------



## Electrical characteristics (HF) at 20°C

Frequency MHz	Attenuation dB/100 m		NEXT dB		PS-NEXT dB		ACR dB at 100 m		PS-ACR dB at 100 m		EL-FEXT dB at 100 m		PS-ELFEXT dB at 100 m		RL dB	
	Typ.	Cat. 7 <sub>A</sub> max.*	Typ.	Cat. 7 <sub>A</sub> min.*	Typ.	Cat. 7 <sub>A</sub> min.*	Typ.	Cat. 7 <sub>A</sub> min.*	Typ.	Cat. 7 <sub>A</sub> min.*	Typ.	Cat. 7 <sub>A</sub> min.*	Typ.	Cat. 7 <sub>A</sub> min.*	Typ.	Cat. 7 <sub>A</sub> min.*
1	1.8	2.1	105	78	102	75	103	75.9	100	72.9	106	78	103	75	32	20
10	4.7	5.8	105	78	102	75	100	72.2	97	69.2	98	75.3	95	72.3	35	25
100	16.4	18.5	105	75.4	102	72.4	89	56.9	86	53.9	87	55.3	84	52.3	26	20.1
200	23.6	26.5	101	70.9	98	67.9	77	44.4	74	41.4	80	49.3	77	46.3	25	18
250	26.4	29.7	101	69.4	98	66.4	74	39.7	71	36.7	77	47.3	74	44.3	23	17.3
500	38.2	42.8	100	64.9	97	61.9	62	22.2	59	19.2	64	41.3	61	38.3	21	17.3
600	42.0	47.1	100	63.7	97	60.7	58	16.6	55	13.6	59	39.7	56	36.7	21	17.3
800	48.5	54.9	95	61.9	92	58.9	46	6.9	43	3.9	53	37.2	50	34.2	19	16.1
900	52.0	58.5	95	61.1	92	58.1	43	2.6	40	-0.4	49	36.2	46	33.2	18	15.5
1000	55.3	61.9	92	60.4	89	57.4	37	-1.5	34	-4.5	45	35.3	42	32.3	18	15.1
1200	61.7	-	88	-	85	-	26	-	23	-	38	-	35	-	18	-
1300	64.8	-	81	-	78	-	16	-	13	-	35	-	32	-	16	-
1400	66.2	-	74	-	71	-	8	-	5	-	34	-	31	-	10	-
1500	68.5	-	73	-	70	-	5	-	2	-	31	-	28	-	9	-

\* EN 50288-9-1(2013)/IEC 61156-5(2009). If IO FEXT is min. 90 dB, EL-FEXT is fulfilled by design.

## Electrical characteristics at 20°C

Direct current resistance	Max.	65Ω/km
Insulation resistance	Min.	5 GΩ x km
Mutual capacitance	Approx.	42 pF/m
Capacitive coupling (e)	Approx.	1100 pF/km
Velocity of propagation (c)	Approx.	0.77
Propagation delay	Approx.	420 ns/100 m
Skew at 100 MHz	Approx.	5 ns/100 m
Charact. impedance	at 100 MHz	100 ± 5 Ω
Testing voltage U <sub>eff</sub>		1000 V
Operating voltage	Max.	125 V

## Thermal properties

For fixed installation	-20 °C up to +60 °C
For mobile operation	0°C up to +50°C

## Chemical characteristics

Free of hazardous substances according to RoHS 2011/65/EU

## Cable printing for 4 P

KERPEN DATACOM Made in Germany **MegaLine®** Pro 1500 25G  
4PPoE "CPR Class" "DoP no." "Batch number" "Metre marking"

## Certificates and approvals

Link performance: KERPEN DATACOM **MegaLine®** systems  
and other commercially available connector systems  
Test certificates: according to DIN 55350-18-4.2.1 or EN 10204  
Compliant with LVD (2014/35/EU): **CE**  
Compliant with Construction Products Regulation  
(EU/305/2011): **CE**

Dimensions	Outer Ø approx.	Weight approx.	Copper sales factor*	CPR Class	DoP no.	Sheath colour	Order no.
	mm	kg/km	kg/km				
4P	8.4	68	38	D <sub>ca</sub> s2 d2 a1	CDESK0000007	◆ Colza yellow	LKD7KS80026xxxx
2 x 4P	8.4 x 17.5	141	76	D <sub>ca</sub> s2 d2 a1	CDESK0000008	◆ Colza yellow	LKD7KS80028xxxx

Packaging: xxxx

Standard length: 0100 = 1000 m 0050 = 500 m 0000 = general

\* See page 17: Definition of copper sales factor

# MegaLine® Pro 1300

## Category 7<sub>A</sub>



Types KS-02YSCH 4x2x0,62 mm/~AWG 22/1 PIMF  
KS-02YSCH 4x2x0.62 mm/~AWG 22/1 PIMF

### Benefits

- ▶ Better than category 7<sub>A</sub>
- ▶ Bandwidth 1300 MHz
- ▶ RoHS and REACH conformity

### Construction for 4P

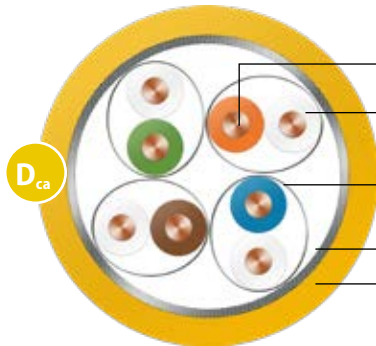

<b>Conductor</b>	Bare copper wire, 0.62mm/~AWG 22/1
<b>Insulation</b>	Foam PE, core Ø: Nominal value 1.5 mm
<b>Twisting element</b>	Pair
<b>Individual shielding</b>	Aluminium-bonded polyester foil, metal on the outside (PiMF)
<b>Twisting</b>	4 pairs
<b>Overall shielding</b>	Tinned copper wire braid
<b>Outer sheath</b>	halogen-free, flame-retardant compound

### Fire behaviour

Flame retardancy	according to IEC 60332-3-24
Halogen free	according to IEC 60754-1/2
Smoke density	according to IEC 61034-1/2
Acidity	according to EN 60754-2
Fire load (reference value)	0.74 MJ/m (Sx), 1.5 MJ/m (Dx)
EU Construction Products Regulation	according to EN 50575/EN 50399

### Performance

Better than category 7<sub>A</sub> according to EN 50288 and IEC 61156, excellent NEXT, low attenuation, excellent shielding characteristics (shielding in pairs and overall shielding), low skew, bandwidth (typical): 1300 MHz

### Applications

Installation cable for use in structured building cabling according to ISO/IEC 11801 and EN 50173 (3rd edition). Ideal for all applications of Classes D to F<sub>A</sub>, multimedia (TV, video, data, voice) >10 GbE according to IEEE 802.3an, 25G in line with TR-11801-9905 in channel links up to 50 m, cable sharing, PoE/PoE+/4PPoE.

### Mechanical characteristics

Bending radius	During installation	8 x outer diameter (min.)
	After installation	4 x outer diameter (min.)
Tensile strength (max.)		130 N (Sx), 260 N (Dx)
Crush strength		1000 N/100 mm
Impact strength (number of shocks)		10

### Electromagnetic behaviour

Coupling resistance at 10 MHz (nom.)	5 mΩ/m
Screen attenuation (nom.)	70 dB
Coupling attenuation (nom.)	85 dB
Separating class according to EN 50174-2	d

### Security (fire behaviour)

S	1 IEC 60332-2-2	2 IEC-60332-1-2 E <sub>ca</sub> /D <sub>ca</sub>	3 IEC-60332-3-24 E <sub>ca</sub> /D <sub>ca</sub>	4 EFP Grade 1 C <sub>ca</sub>	5 EFP Grade 2 B2 <sub>ca</sub>
---	--------------------	--	---	-------------------------------------	--------------------------------------

### Performance (cabling class, bandwidth)

P	1 > Class E > 250 MHz	2 > Class E <sub>A</sub> > 500 MHz	3 > Class F > 600 MHz	4 > Class F <sub>A</sub> > 1000 MHz	5 > Class F <sub>A</sub> + > 1200 MHz
---	-----------------------------	--	-----------------------------	---	---

### Application (Ethernet, TV)

A	1 > 100 MbE	2 > 1 GbE	3 Up to 10 GbE	4 > 10 GbE	5 > 10 GbE TV
---	----------------	--------------	-------------------	---------------	------------------

### Construction (conductor dimension, tensile strength)

C	1 AWG 27	2 AWG 26/25	3 AWG 24	4 AWG 23	5 AWG 22
---	-------------	----------------	-------------	-------------	-------------

### EMC (coupling attenuation)

E	1 > 40 dB	2 > 50 dB	3 > 60 dB	4 > 70 dB	5 > 80 dB
---	--------------	--------------	--------------	--------------	--------------

### Electrical characteristics (HF) at 20°C

Frequency MHz	Attenuation dB/100 m		NEXT dB		PS-NEXT dB		ACR dB at 100 m		PS-ACR dB at 100 m		EL-FEXT dB at 100 m		PS-ELFEXT dB at 100 m		RL dB	
	Typ.	Cat. 7 <sub>A</sub> max.*	Typ.	Cat. 7 <sub>A</sub> min.*	Typ.	Cat. 7 <sub>A</sub> min.*	Typ.	Cat. 7 <sub>A</sub> min.*	Typ.	Cat. 7 <sub>A</sub> min.*	Typ.	Cat. 7 <sub>A</sub> min.*	Typ.	Cat. 7 <sub>A</sub> min.*	Typ.	Cat. 7 <sub>A</sub> min.*
1	1.8	2.1	105	78	102	75	104	75.9	101	72.9	105	78	102	75	32.6	20
10	4.7	5.8	105	78	102	75	101	72.2	98	69.2	108	75.3	105	72.3	31.5	25
100	15.9	18.5	105	75.4	102	72.4	89	56.9	86	53.9	93	55.3	90	52.3	29.0	20.1
200	23.5	26.5	105	70.9	102	67.9	81	44.4	78	41.4	85	49.3	82	46.3	25.4	18
250	26.6	29.7	105	69.4	102	66.4	79	39.7	76	36.7	82	47.3	79	44.3	24.1	17.3
500	37	42.8	100	64.9	97	61.9	63	22.2	60	19.2	70	41.3	67	38.3	21.6	17.3
600	41.8	47.1	95	63.7	92	60.7	53	16.6	50	13.6	63	39.7	60	36.7	19.8	17.3
700	45.2	51.1	95	62.7	92	59.7	50	11.6	47	8.6	60	38.4	57	35.4	21.1	16.6
800	48	54.9	93	61.9	90	58.9	45	6.9	42	3.9	57	37.2	54	34.2	21.0	16.1
900	52.3	58.5	90	61.1	87	58.1	38	2.6	35	-0.4	53	36.2	50	33.2	20.0	15.5
1000	55.2	61.9	88	60.4	85	57.4	33	-1.5	30	-4.5	48	35.3	45	32.3	20.0	15.1
1100	57.6	-	87	-	84	-	29	-	26	-	44	-	41	-	18.8	-
1300	64.9	-	80	-	77	-	15	-	13	-	39	-	36	-	17.6	-

\* EN 50288-9-1 (2013) / IEC 61156-5 (2009)

### Electrical characteristics at 20°C

Direct current resistance	Max.	65 Ω/km
Insulation resistance	Min.	5 GΩ x km
Mutual capacitance	Approx.	42 pF/m
Capacitive coupling (e)	Approx.	1100 pF/km
Velocity of propagation (c)	Approx.	0.80
Propagation delay	Approx.	420 ns/100 m
Skew at 100 MHz	Approx.	5 ns/100 m
Charact. impedance	at 100 MHz	100 ± 5 Ω
Testing voltage U <sub>eff</sub>		1000 V
Operating voltage	Max.	125 V

### Thermal properties

For fixed installation	-20 °C up to +60 °C
For mobile operation	0°C up to +50°C

### Chemical characteristics

Free of hazardous substances according to RoHS 2011/65/EU

### Cable printing for 4P

KERPEN DATACOM Made in Germany **MegaLine®** Pro 1300 25G  
4PPoE "CPR Class" "DoP no." "Batch number" "Metre marking"

### Certificates and approvals

Link performance: KERPEN DATACOM **MegaLine®** systems  
and other commercially available connector systems  
Test certificates: according to DIN 55350-18-4.2.1 or EN 10204  
Compliant with LVD (2014/35/EU): **CE**  
Compliant with Construction Products Regulation  
(EU/305/2011): **CE**

Dimensions	Outer Ø approx.	Weight approx.	Copper sales factor*	CPR Class	DoP no.	Sheath colour	Order no.
	mm	kg/km	kg/km				
4P	8.1	67	38	D <sub>ca</sub> s2 d2 a1	CDESK0000007	◆ Colza yellow	LKD7KS70380xxxx
2 x 4P	8.1 x 16.4	135	76	D <sub>ca</sub> s2 d2 a1	CDESK0000008	◆ Colza yellow	LKD7KS70381xxxx

Packaging: xxxx

Standard length: 0100 = 1000 m 0050 = 500 m 0000 = general

\* See page 17: Definition of copper sales factor

# MegaLine® Pro 1000

## Category 7



Types KS-02YSCH 4x2xAWG 23/1 PIMF  
KS-02YSCH 2x(4x2xAWG 23/1 PIMF)

### Benefits

- ▶ Better than category 7
- ▶ Bandwidth 1000 MHz
- ▶ RoHS and REACH conformity

### Construction for 4P

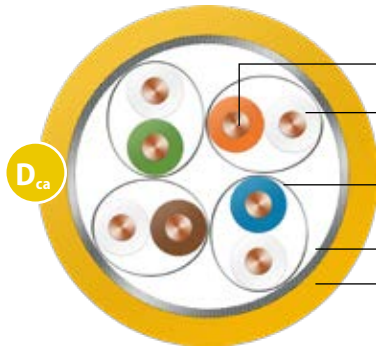

<b>Conductor</b>	Bare copper wire, AWG 23/1
<b>Insulation</b>	Foam PE, core Ø: Nominal value 1.3 mm
<b>Twisting element</b>	Pair
<b>Individual shielding</b>	Aluminium-bonded polyester foil, metal on the outside (PIMF)
<b>Twisting</b>	4 pairs
<b>Overall shielding</b>	Tinned copper wire braid
<b>Outer sheath</b>	halogen-free, flame-retardant compound

### Fire behaviour

Flame retardancy	according to IEC 60332-3-24 / EN 50266-2-4
Halogen free	according to IEC 60754-1/2
Smoke density	according to IEC 61034-1/2
Acidity	according to EN 60754-2
Fire load (reference value)	0.5 MJ/m (Sx), 1.2 MJ/m (Dx)
EU Construction Products Regulation	according to EN 50575 / EN 50399

### Performance

Better than category 7 according to EN 50288 and IEC 61156, excellent NEXT, good shielding characteristics (shielding in pairs or overall shielding), low skew, bandwidth (typical): 1000 MHz

### Applications

Installation cable for use in structured building cabling according to ISO/IEC 11801 and EN 50173 (3rd edition). Ideal for all applications of Classes D to F, multimedia (video, data, voice) > 10 GbE according to IEEE 802.3an, cable sharing, VoIP, PoE/PoE+/4PPoE.

### Mechanical characteristics

Bending radius	During installation	8 x outer diameter (min.)
	After installation	4 x outer diameter (min.)
Tensile strength (max.)		100 N (Sx), 220 N (Dx)
Crush strength		1000 N/100 mm
Impact strength (number of shocks)		10

### Electromagnetic behaviour

Coupling resistance at 10 MHz (nom.)	5 mΩ/m
Screen attenuation (nom.)	70 dB
Coupling attenuation (nom.)	85 dB
Separating class according to EN 50174-2	d

### Security (fire behaviour)

S	1 IEC 60332-2-2	2 IEC-60332-1-2	3 IEC-60332-3-24	4 EFP Grade 1	5 EFP Grade 2
		E <sub>ca</sub> /D <sub>ca</sub>	E <sub>ca</sub> /D <sub>ca</sub>	C <sub>ca</sub>	B2 <sub>ca</sub>

### Performance (cabling class, bandwidth)

P	1 > Class E > 250 MHz	2 > Class E <sub>A</sub> > 500 MHz	3 > Class F > 600 MHz	4 > Class F <sub>A</sub> > 1000 MHz	5 > Class F <sub>A</sub> + > 1200 MHz

### Application (Ethernet, TV)

A	1 > 100 MbE	2 > 1 GbE	3 Up to 10 GbE	4 > 10 GbE	5 > 10 GbE TV

### Construction (conductor dimension, tensile strength)

C	1 AWG 27	2 AWG 26/25	3 AWG 24	4 AWG 23	5 AWG 22

### EMC (coupling attenuation)

E	1 > 40 dB	2 > 50 dB	3 > 60 dB	4 > 70 dB	5 > 80 dB

### Electrical characteristics (HF) at 20°C

Frequency MHz	Attenuation dB/100 m		NEXT dB		PS-NEXT dB		ACR dB at 100 m		PS-ACR dB at 100 m		EL-FEXT dB at 100 m		PS-ELFEXT dB at 100 m		RL dB	
	Typ.	Cat. 7 max.*	Typ.	Cat. 7 min.*	Typ.	Cat. 7 min.*	Typ.	Cat. 7 min.*	Typ.	Cat. 7 min.*	Typ.	Cat. 7 min.*	Typ.	Cat. 7 min.*	Typ.	Cat. 7 min.*
1	1.95	2	100	80	97	77	98	78	95	75	100	80	97	77	27	23
10	5.5	5.7	100	80	97	77	94	74	91	71	100	74	97	71	30	25
100	18.4	18.5	100	72	97	69	81	54	78	51	86	54	83	51	25	20.1
200	26.3	26.8	90	68	87	65	63	41	60	38	81	48	78	45	21	18
250	29.4	30.2	90	66	87	63	60	36	57	33	72	46	69	43	20	17.3
500	42.3	44.1	85	62	82	59	42	18	39	15	60	40	57	37	19	17.3
600	46.3	48.9	85	61	82	58	38	12	35	9	52	38	49	35	18	17.3
1000	64	-	70	-	67	-	6	-	3	-	29	-	26	-	15	-

\* EN 50288-4-1 (2014)/IEC 61156-5 (2009)

### Electrical characteristics at 20°C

Direct current resistance	Max.	78 Ω/km
Insulation resistance	Min.	5 GΩ x km
Mutual capacitance	Approx.	40 pF/m
Capacitive coupling (e)	Approx.	1100 pF/km
Velocity of propagation (c)	Approx.	0.79
Propagation delay	Approx.	400 ns/100 m
Skew at 100 MHz	Approx.	5 ns/100 m
Charact. impedance	at 100 MHz	100 ± 5 Ω
Testing voltage U <sub>eff</sub>		1000 V
Operating voltage	Max.	125 V

### Thermal properties

For fixed installation	-20 °C up to +60 °C
For mobile operation	0°C up to +50°C

### Chemical characteristics

Free of hazardous substances according to RoHS 2011/65/EU

### Cable printing for 4 P

KERPEN DATACOM Made in Germany **MegaLine®** Pro 1000 "CPR Class" "DoP no." "Batch number" "Metre marking"

### Certificates and approvals

Link performance: KERPEN DATACOM **MegaLine®** systems and other commercially available connector systems  
 Test certificates: according to DIN 55350-18-4.2.1 or EN 10204  
 Compliant with LVD (2014/35/EU): **CE**  
 Compliant with Construction Products Regulation (EU/305/2011): **CE**

Dimensions	Outer Ø approx.	Weight approx.	Copper sales factor*	CPR Class	DoP no.	Sheath colour	Order no.
	mm	kg/km	kg/km				
4P	7.4	56	32	D <sub>ca</sub> s2 d2 a1	CDESK0000005	◆ Colza yellow	LKD7KS70305xxxx
2 x 4P	7.4 x 14.8	112	64	D <sub>ca</sub> s2 d2 a1	CDESK0000006	◆ Colza yellow	LKD7KS70308xxxx

Packaging: xxxx

Standard length: 0100 = 1000 m 0050 = 500 m 0000 = general

\* See page 17: Definition of copper sales factor

# MegaLine® G20 S/F Flex

## Category 8.2



Type KS-02YSCH 4x2xAWG 26/7 PIMF

### Benefits

- ▶ Data centre cabling
- ▶ Better than Cat. 8.2
- ▶ Bandwidth 2000 MHz
- ▶ Excellent shielding characteristics
- ▶ RoHS and REACH conformity

### Construction for 4P

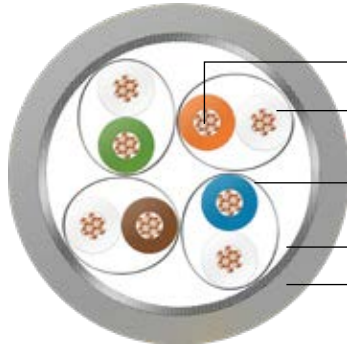

<b>Conductor</b>	Bare stranded copper wire, AWG26/7
<b>Insulation</b>	Foam PE, core Ø: Nominal value 1.07 mm
<b>Twisting element</b>	Pair
<b>Individual shielding</b>	Aluminium-bonded polyester foil, metal on the outside (PiMF)
<b>Twisting</b>	4 pairs
<b>Overall shielding</b>	Tinned copper wire braid
<b>Outer sheath</b>	halogen-free, flame-retardant compound

### Fire behaviour

Flame retardancy	according to IEC 60332-1-2
Halogen free	according to IEC 60754-1/2
Smoke density	according to IEC 61034-1/2
Fire load (reference value)	0.38 MJ/m
EU Construction Products Regulation	according to EN 50575 / EN 50399

### Performance

Better than Category 8.2 according to draft IEC 61156-10, excellent NEXT, low attenuation, excellent shielding characteristics (pairs and overall shielding), low skew, bandwidth (typical): 2000 MHz

### Applications

Connection cables and patch cords for use in structured building cabling according to ISO/IEC 11801 and EN 50173 (3rd edition) and for data centre cabling in accordance with ISO/IEC 24764 and EN 50173-5 as well as PDTR 11801-9901. Ideal for all applications of Classes D to F<sub>A</sub> and Class II, multimedia (TV, video, data, voice) >40 GbE according to IEEE 802.3bq (draft), cable sharing, VoIP, PoE/PoE+/4PPoE.

### Mechanical characteristics

Bending radius	in operation	5 x outer diameter (min.)
Tensile strength (max.)		60 N

### Electromagnetic behaviour

Coupling resistance at 10 MHz (nom.)	5 mΩ/m
Screen attenuation (nom.)	60 dB
Coupling attenuation (nom.)	85 dB
Separating class according to EN 50174-2	d

### Security (fire behaviour)

S	1 IEC 60332-2-2	2 IEC-60332-1-2	3 IEC-60332-3-24	4 EFP Grade 1	5 EFP Grade 2
		E <sub>ca</sub> /D <sub>ca</sub>	E <sub>ca</sub> /D <sub>ca</sub>	C <sub>ca</sub>	B2 <sub>ca</sub>

### Performance (cabling class, bandwidth)

P	1 > Class E > 250 MHz	2 > Class E <sub>A</sub> > 500 MHz	3 > Class F > 600 MHz	4 > Class F <sub>A</sub> > 1000 MHz	5 > Class F <sub>A</sub> + > 1200 MHz
---	-----------------------------	--	-----------------------------	---	---

### Application (Ethernet, TV)

A	1 > 100 MbE	2 > 1 GbE	3 Up to 10 GbE	4 > 10 GbE	5 > 10 GbE TV
---	----------------	--------------	-------------------	---------------	------------------

### Construction (conductor dimension, tensile strength)

C	1 AWG 27	2 AWG 26/25	3 AWG 24	4 AWG 23	5 AWG 22
---	-------------	----------------	-------------	-------------	-------------

### EMC (coupling attenuation)

E	1 > 40 dB	2 > 50 dB	3 > 60 dB	4 > 70 dB	5 > 80 dB
---	--------------	--------------	--------------	--------------	--------------

### Electrical characteristics (HF) at 20°C

Frequency MHz	Attenuation dB/50 m		NEXT dB		PS-NEXT dB		ACR dB at 30 m		PS-ACR dB at 30 m		EL-FEXT dB		PS-ELFEXT dB		RL dB	
	Typ.	Cat. 8.2 max.*	Typ.	Cat. 8.2 min.*	Typ.	Cat. 8.2 min.*	Typ.	Cat. 8.2 min.*	Typ.	Cat. 8.2 min.*	Typ.	Cat. 8.2 min.*	Typ.	Cat. 8.2 min.*	Typ.	Cat. 8.2 min.*
10	1.7	2.6	100.0	90.4	97	87.4	98	87.8	95	84.8	95	80.8	92	77.8	28.4	25.0
100	6.4	8.3	100.0	75.4	97	72.4	94	67.1	91	64.1	95	60.8	92	57.8	31.2	22.2
250	10.3	13.4	100.0	69.4	97	66.4	90	56.1	87	53.1	90	52.8	87	49.8	28.4	19.4
500	15.0	19.2	94	64.9	91	61.9	79	45.7	76	42.7	84	46.8	81	43.8	25.6	17.3
600	16.4	21.2	93	63.7	90	60.7	77	42.5	74	39.5	82	45.2	79	42.2	24.7	16.8
1000	21.2	27.9	77	60.4	74	57.4	56	32.5	53	29.5	66	40.8	63	37.8	17.5	15.2
1200	23.2	30.8	72	59.2	69	56.2	49	28.4	46	25.4	61	39.2	58	36.2	17.1	14.7
1500	26.1	34.7	72	57.8	69	54.8	45	23.0	42	20.0	56	37.3	53	34.3	16.1	14.0
1600	27.4	36.0	72	57.3	69	54.3	44	21.3	41	18.3	55	36.7	52	33.7	15.8	13.8
1700	28.6	37.2	71	56.9	68	53.9	43	19.7	40	16.7	53	36.2	50	33.2	14.2	13.6
1800	29.3	38.4	66	56.6	63	53.6	37	18.2	34	15.2	53	35.7	50	32.7	14.0	13.4
1900	30.4	39.6	65	56.2	62	53.2	35	16.6	32	13.6	46	35.2	43	32.2	13.8	13.3
2000	31.4	40.7	63	55.9	60	52.9	32	15.2	29	12.2	43	34.8	40	31.8	13.5	13.1

\* IEC 61156-10 (2016). If IO FEXT is min. 90 dB to 1000 MHz and min. 80 dB to 2,000 MHz, EL-FEXT is fulfilled by design.

### Electrical characteristics at 20°C

Direct current resistance	Max.	145 Ω/km
Insulation resistance	Min.	5 GΩ x km
Mutual capacitance	Approx.	43 pF/m
Velocity of propagation (c)	Approx.	0.78
Propagation delay	Approx.	430 ns/100 m
Skew at 100 MHz	Approx.	5 ns/100 m
Charact. impedance	at 100 MHz	100 ± 5 Ω
Testing voltage U <sub>eff</sub>		1000 V
Operating voltage	Max.	125 V

### Thermal properties

For fixed installation	-20 °C up to +60 °C
For mobile operation	0°C up to +50°C

### Chemical characteristics

Free of hazardous substances according to RoHS 2011/65/EU

### Cable printing

KERPEN DATACOM Made in Germany **MegaLine®** G20 S/F Flex 4P  
H "CPR Class" "DoP no." "Batch number" "Metre marking"

### Certificates and approvals

Link performance: KERPEN DATACOM **MegaLine®** systems  
and other commercially available connector systems  
Test certificates: according to DIN 55350-18-4.2.1 or EN 10204  
Compliant with LVD (2014/35/EU): **CE**  
Compliant with Construction Products Regulation  
(EU/305/2011): **CE**

Dimensions	Outer Ø approx.	Weight approx.	Copper sales factor*	CPR Class	DoP no.	Sheath colour	Order no.
	mm	kg/km	kg/km				
4P	5.8	41	23.5	D <sub>ca</sub> s2 d2 a1	CDESK0000023	◆ Light grey	LKD7KS80013xxxx

Packaging: xxxx

Standard length: 0100 = 1000 m 0050 = 500 m 0000 = general

\* See page 17: Definition of copper sales factor

# MegaLine® F10-120 S/F Flex

## Category 7<sub>A</sub>



Types KS-02YSCH 4x2xAWG 26/7 PIMF

### Benefits

- ▶ Better than category 7
- ▶ Bandwidth 1200 MHz
- ▶ Excellent shielding characteristics
- ▶ RoHS and REACH conformity

### Construction for 4P

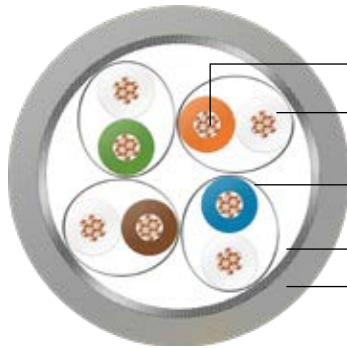

<b>Conductor</b>	Bare stranded copper wire, AWG26/7
<b>Insulation</b>	Foam PE, core Ø: Nominal value 1.05 mm
<b>Twisting element</b>	Pair
<b>Individual shielding</b>	Aluminium-bonded polyester foil, metal on the outside (PiMF)
<b>Twisting</b>	4 pairs
<b>Overall shielding</b>	Tinned copper wire braid
<b>Outer sheath</b>	halogen-free, flame-retardant compound

### Fire behaviour

Flame retardancy	according to IEC 60332-1-2
Halogen free	according to IEC 60754-1/2
Smoke density	according to IEC 61034-1/2
Fire load (reference value)	0.38 MJ/m (Sx)
EU Construction Products Regulation	according to EN 50575 / EN 50399

### Performance

Better than Category 7 according to EN 50288 and IEC 61156  
excellent NEXT, low attenuation,  
excellent shielding characteristics (pairs and overall shielding),  
low skew, bandwidth (typical): 1200 MHz

### Applications

Collection point cables, connection cables and patch cords for use in structured building cabling according to ISO/IEC 11801 and EN 50173 (3rd Edition), as well as ISO/IEC 24764 and EN 50173-5. Ideal for all applications of Classes D to F<sub>A</sub>, multimedia (TV, video, data, voice) >10 GbE according to IEEE 802.3an, cable sharing, VoIP, PoE/PoE+/4PPoE.

### Mechanical characteristics

Bending radius	in operation	5 x outer diameter (min.)
Tensile strength (max.)		60 N (Sx), 400 N (8-fold)

### Electromagnetic behaviour

Coupling resistance at 10 MHz (nom.)	5 mΩ/m
Screen attenuation (nom.)	60 dB
Coupling attenuation (nom.)	85 dB
Separating class according to EN 50174-2	d

### Security (fire behaviour)

<b>S</b>	1 IEC 60332-2-2	2 IEC-60332-1-2	3 IEC-60332-3-24	4 EFP Grade 1	5 EFP Grade 2
		E <sub>ca</sub> /D <sub>ca</sub>	E <sub>ca</sub> /D <sub>ca</sub>	C <sub>ca</sub>	B2 <sub>ca</sub>

### Performance (cabling class, bandwidth)

<b>P</b>	1 > Class E > 250 MHz	2 > Class E <sub>A</sub> > 500 MHz	3 > Class F > 600 MHz	4 > Class F <sub>A</sub> > 1000 MHz	5 > Class F <sub>A</sub> + > 1200 MHz

### Application (Ethernet, TV)

<b>A</b>	1 > 100 MbE	2 > 1 GbE	3 Up to 10 GbE	4 > 10 GbE	5 > 10 GbE TV

### Construction (conductor dimension, tensile strength)

<b>C</b>	1 AWG 27	2 AWG 26/25	3 AWG 24	4 AWG 23	5 AWG 22

### EMC (coupling attenuation)

<b>E</b>	1 > 40 dB	2 > 50 dB	3 > 60 dB	4 > 70 dB	5 > 80 dB



## Electrical characteristics (HF) at 20°C

Frequency MHz	Attenuation dB/10m		NEXT dB		PS-NEXT dB		ACR dB at 10m		PS-ACR dB at 10m		EL-FEXT dB at 10m		PS-ELFEXT dB at 10m		RL dB	
	Typ.	Cat. 7 <sub>A</sub> max.*	Typ.	Cat. 7 <sub>A</sub> min.*	Typ.	Cat. 7 <sub>A</sub> min.*	Typ.	Cat. 7 <sub>A</sub> min.*	Typ.	Cat. 7 <sub>A</sub> min.*	Typ.	Cat. 7 <sub>A</sub> min.*	Typ.	Cat. 7 <sub>A</sub> min.*	Typ.	Cat. 7 <sub>A</sub> min.*
1	0.25	0.29	100	80	97	77	100	80	97	77	100	80	97	77	24	23
10	0.76	0.85	99	80	96	77	99	79	96	77	95	74	92	71	33.9	25
100	2.49	2.78	95	78	92	75	93	75	90	72	69	54	66	51	38.3	20.1
200	3.69	3.97	92	74	89	71	88	70	85	67	65	48	62	45	35.3	18
250	4.18	4.46	90	72	87	69	86	68	83	65	62	46	59	43	32.9	17.3
500	5.6	6.41	83	68	80	65	78	62	75	59	54	40	51	37	29.7	17.3
600	6.74	7.06	81	67	78	64	74	60	71	57	50	38	47	35	30.6	17.3
700	7.32	7.67	80	66	77	63	72	58	69	55	50	37	47	34	31	15
800	7.89	8.24	77	65	74	62	69	57	66	54	50	36	47	33	26.7	14.5
900	8.5	8.78	75	64	72	61	67	55	64	52	36	35	33	32	28.6	14.1
1000	9.11	9.29	74	63.4	71	60	65	54	62	51	35	34	32	31	27.5	13.7
1100	9.5	-	72	-	69	-	63	-	60	-	28	-	25	-	26.9	-
1200	9.9	-	70	-	67	-	61	-	58	-	24	-	21	-	26.3	-

\* EN 50288-9-2 (2015)/IEC 61156-6 (2010)

## Electrical characteristics at 20°C

Direct current resistance	Max.	145 Ω/km
Insulation resistance	Min.	5 GΩ x km
Mutual capacitance	Approx.	44 pF/m
Velocity of propagation (c)	Approx.	0.78
Propagation delay	Approx.	440 ns/100 m
Skew at 100 MHz	Approx.	2.5 ns/100 m
Charact. impedance	at 100 MHz	100 ± 5 Ω
Testing voltage U <sub>eff</sub>		1000 V
Operating voltage	Max.	125 V

## Thermal properties

For fixed installation	-20 °C up to +60 °C
For mobile operation	0°C up to +50°C

## Chemical characteristics

Free of hazardous substances according to RoHS 2011/65/EU

## Cable printing for 4 P

KERPEN DATACOM Made in Germany **MegaLine®** F10-120 S/F  
Flex 4P H "CPR Class" "DoP no." "Batch number" "Metre marking"

## Certificates and approvals

Link performance: KERPEN DATACOM **MegaLine®** systems  
and other commercially available connector systems  
Test certificates: according to DIN 55350-18-4.2.1 or EN 10204  
Compliant with LVD (2014/35/EU): **CE**  
Compliant with Construction Products Regulation  
(EU/305/2011): **CE**

Dimensions	Outer Ø approx.	Weight approx.	Copper sales factor*	CPR Class	DoP no.	Sheath colour	Order no.
	mm	kg/km	kg/km				
4P	5.8	41	23.5	D <sub>ca</sub> s2 d2 a1	CDESK0000023	◆ Light grey	LKD7KS70003xxxx

Packaging: xxxx

Standard length: 0100 = 1000 m 0050 = 500 m 0000 = general

\* See page 17: Definition of copper sales factor

# MegaLine® F6-90 S/F Flex

## Category 7



Type KS-02YSCH 4x2xAWG 27/7 PIMF

### Benefits

- ▶ Better than category 7
- ▶ Bandwidth 900 MHz
- ▶ Excellent shielding characteristics
- ▶ RoHS and REACH conformity

### Construction for 4P

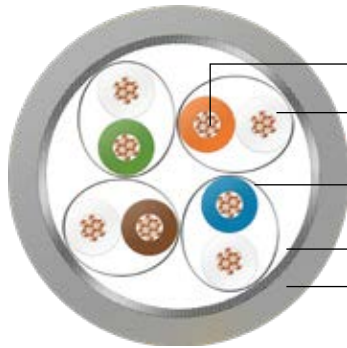

<b>Conductor</b>	Bare stranded copper wire, AWG27/7
<b>Insulation</b>	Foam PE, core Ø: Nominal value 1.0 mm
<b>Twisting element</b>	Pair
<b>Individual shielding</b>	Aluminium-bonded polyester foil, metal on the outside (PiMF)
<b>Twisting</b>	4 pairs
<b>Overall shielding</b>	Tinned copper wire braid
<b>Outer sheath</b>	halogen-free, flame-retardant compound

### Fire behaviour

Flame retardancy	according to IEC 60332-1-2
Halogen free	according to IEC 60754-1/2
Smoke density	according to IEC 61034-1/2
Fire load (reference value)	0.33 MJ/m
EU Construction Products Regulation	according to EN 50575 / EN 50399

### Performance

Better than Category 7 according to EN 50288 and IEC 61156  
excellent NEXT, excellent shielding characteristics (pairs and overall shielding),  
low skew, bandwidth (typical): 900 MHz

### Applications

Connection cables and patch cords for use in structured building cabling according to ISO/IEC 11801 and EN 50173 (3rd edition). Ideal for all applications of Classes D to F, multimedia (video, data, voice) > 10 GbE according to IEEE 802.3an, cable sharing, VoIP, PoE/PoE+/4PPoE.

### Mechanical characteristics

Bending radius	in operation	5 x outer diameter (min.)
Tensile strength (max.)		40 N

### Electromagnetic behaviour

Coupling resistance at 10 MHz (nom.)	5 mΩ/m
Screen attenuation (nom.)	60 dB
Coupling attenuation (nom.)	80 dB
Separating class according to EN 50174-2	d

### Security (fire behaviour)

<b>S</b>	1 IEC 60332-2-2	2 IEC-60332-1-2	3 IEC-60332-3-24	4 EFP Grade 1	5 EFP Grade 2
		E <sub>ca</sub> /D <sub>ca</sub>	E <sub>ca</sub> /D <sub>ca</sub>	C <sub>ca</sub>	B2 <sub>ca</sub>

### Performance (cabling class, bandwidth)

<b>P</b>	1 > Class E > 250 MHz	2 > Class E <sub>A</sub> > 500 MHz	3 > Class F > 600 MHz	4 > Class F <sub>A</sub> > 1000 MHz	5 > Class F <sub>A+</sub> > 1200 MHz

### Application (Ethernet, TV)

<b>A</b>	1 > 100 MbE	2 > 1 GbE	3 Up to 10 GbE	4 > 10 GbE	5 > 10 GbE TV

### Construction (conductor dimension, tensile strength)

<b>C</b>	1 AWG 27	2 AWG 26/25	3 AWG 24	4 AWG 23	5 AWG 22

### EMC (coupling attenuation)

<b>E</b>	1 > 40 dB	2 > 50 dB	3 > 60 dB	4 > 70 dB	5 > 80 dB

## Electrical characteristics (HF) at 20°C

Frequency MHz	Attenuation dB/10m		NEXT dB		PS-NEXT dB		ACR dB at 10m		PS-ACR dB at 10m		EL-FEXT dB at 10m		PS-ELFEXT dB at 10m		RL dB	
	Typ.	Cat. 7 max.*	Typ.	Cat. 7 min.*	Typ.	Cat. 7 min.*	Typ.	Cat. 7 min.*	Typ.	Cat. 7 min.*	Typ.	Cat. 7 min.*	Typ.	Cat. 7 min.*	Typ.	Cat. 7 min.*
1	0.26	0.29	95	80	92	77	95	80	92	77	92	80	89	80	21.8	-
10	0.83	0.85	94	80	91	77	94	79	91	77	84	74	81	71	29.7	25
100	2.74	2.78	90	72	87	69	88	70	85	69	70	54	67	51	35	20.1
200	3.9	4.01	87	68	84	65	83	64	80	65	60	48	57	45	33	18
250	4.39	4.53	85	66	82	63	81	62	78	63	56	46	53	43	31.6	17.3
500	6.21	6.62	78	62	75	59	72	55	69	59	52	40	49	37	28.8	17.3
600	6.91	7.33	76	61	73	58	69	53	66	58	48	38	45	35	27.1	17.3
700	7.48	-	75	-	72	-	67	-	64	-	34	-	31	-	26.4	-
800	8.06	-	72	-	69	-	64	-	61	-	34	-	31	-	24.7	-
900	8.62	-	70	-	67	-	62	-	59	-	11	-	8	-	24.4	-

\* EN 50288-4-2 (2014)/IEC 61156-6 (2010)

## Electrical characteristics at 20°C

Direct current resistance	Max.	170 Ω/km
Insulation resistance	Min.	5 GΩ x km
Mutual capacitance	Approx.	44 pF/m
Velocity of propagation (c)	Approx.	0.78
Propagation delay	Approx.	430 ns/100 m
Skew at 100 MHz	Approx.	2.5 ns/100 m
Charact. impedance	at 100 MHz	100 ± 5 Ω
Testing voltage U <sub>eff</sub>		1000 V
Operating voltage	Max.	125 V

## Thermal properties

For fixed installation	-20 °C up to +60 °C
For mobile operation	0°C up to +50°C

## Chemical characteristics

Free of hazardous substances according to RoHS 2011/65/EU

## Cable printing

KERPEN DATACOM Made in Germany **MegaLine®** F6-90 S/F Flex  
4P H "CPR Class" "DoP no." "Batch number" "Metre marking"

## Certificates and approvals

Link performance: KERPEN DATACOM **MegaLine®** systems  
and other commercially available connector systems

Test certificates: according to DIN 55350-18-4.2.1 or EN 10204  
Compliant with LVD (2014/35/EU): **CE**  
Compliant with Construction Products Regulation  
(EU/305/2011): **CE**

Dimensions	Outer Ø approx.	Weight approx.	Copper sales factor*	CPR Class	DoP no.	Sheath colour	Order no.
	mm	kg/km	kg/km				
4P	5.7	34	17	D <sub>ca</sub> s2 d2 a1	CDESK0000022	◆ Light grey	LKD7KS70014xxxx
						◆ Colza yellow	LKD7KS70015xxxx
						◆ Turquoise green	LKD7KS70016xxxx
						◆ Sky blue	LKD7KS70017xxxx
						◆ Fire red	LKD7KS70018xxxx
						◆ Black	LKD7KS70412xxxx
						◇ White	LKD7KS70403xxxx
						◆ Heather violet	LKD7KS70384xxxx
◆ Orange	LKD7KS70385xxxx						

Packaging: xxxx Standard length: 0100 = 1000 m 0050 = 500 m 0000 = general \* See page 17: Definition of copper sales factor

# MegaLine® D1-20 SF/U Flex

## Category 5



Type KS-02YS(ST+C)Y 4x2xAWG 26/7

### Benefits

- ▶ Better than category 5
- ▶ Bandwidth 200 MHz
- ▶ good shielding characteristics
- ▶ RoHS and REACH conformity

### Construction for 4P

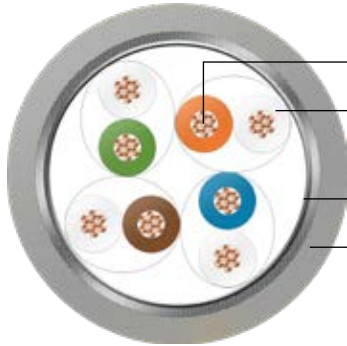

<b>Conductor</b>	Bare copper wire, AWG 26/7
<b>Insulation</b>	Foam PE, core Ø: Nominal value 1.0 mm
<b>Twisting element</b>	Pair
<b>Twisting</b>	4 pairs
<b>Overall shielding</b>	Aluminium-bonded polyester foil and Tinned copper wire braid
<b>Outer sheath</b>	PVC

<b>Fire behaviour</b>	
Flame retardancy	according to IEC 60332-1-2
Fire load (reference value)	0.4 MJ/m

<b>Performance</b>	
Better than Category 5 according to EN 50288 and IEC 61156	
Excellent shielding characteristics	
Bandwidth (typical): 200 MHz	

<b>Applications</b>	
Connection cables and patch cords for use in structured building cabling according to ISO/IEC 11801 and EN 50173 (3rd edition). Ideal for all applications of Classes D up to 1 GbE according to IEEE 802.3ab, VoIP, PoE/PoE+/4PPoE.	

<b>Mechanical characteristics</b>		
Bending radius	in operation	5 x outer diameter (min.)
Tensile strength (max.)		60 N

<b>Electromagnetic behaviour</b>	
Coupling resistance at 10 MHz (nom.)	10 mΩ/m
Screen attenuation (nom.)	50 dB
Coupling damping (nom.) 65 dB	
Separating class according to EN 50174-2	c

### Security (fire behaviour)

<b>S</b>	<b>1</b>	<b>2</b>	<b>3</b>	<b>4</b>	<b>5</b>
	IEC 60332-2-2	IEC-60332-1-2	IEC-60332-3-24	EFP Grade 1	EFP Grade 2

### Performance (cabling class, bandwidth)

<b>P</b>	<b>1</b>	<b>2</b>	<b>3</b>	<b>4</b>	<b>5</b>
	> Class E > 250 MHz	> Class E <sub>x</sub> > 500 MHz	> Class F > 600 MHz	> Class F <sub>x</sub> > 1000 MHz	> Class F <sub>x</sub> + > 1200 MHz

### Application (Ethernet, TV)

<b>A</b>	<b>1</b>	<b>2</b>	<b>3</b>	<b>4</b>	<b>5</b>
	> 100 MbE	> 1 GbE	Up to 10 GbE	> 10 GbE	> 10 GbE TV

### Construction (conductor dimension, tensile strength)

<b>C</b>	<b>1</b>	<b>2</b>	<b>3</b>	<b>4</b>	<b>5</b>
	AWG 27	AWG 26/25	AWG 24	AWG 23	AWG 22

### EMC (coupling attenuation)

<b>E</b>	<b>1</b>	<b>2</b>	<b>3</b>	<b>4</b>	<b>5</b>
	> 40 dB	> 50 dB	> 60 dB	> 70 dB	> 80 dB

## Electrical characteristics (HF) at 20°C

Frequency MHz	Attenuation dB/10m		NEXT dB		PS-NEXT dB		ACR dB at 10m		PS-ACR dB at 10m		EL-FEXT dB at 10m		PS-ELFEXT dB at 10m		RL dB	
	Typ.	Cat. 5 max.*	Typ.	Cat. 5 min.*	Typ.	Cat. 5 min.*	Typ.	Cat. 5 min.*	Typ.	Cat. 5 min.*	Typ.	Cat. 5 min.*	Typ.	Cat. 5 min.*	Typ.	Cat. 5 min.*
1	0.24	0.32	76	65	73	62	76	65	73	62	91	64	88	61	24.9	-
4	0.44	0.60	71	56	68	53	70	56	67	53	76	52	73	49	29.8	23
10	0.80	0.95	64	50	61	47	63	49	60	47	68	44	65	41	38.2	25
16	1.01	1.21	60	47	57	44	59	46	56	44	64	40	61	37	39.3	25
31.25	1.44	1.71	56	43	53	40	54	41	51	40	58	34	55	31	36.7	23.6
62.5	2.07	2.48	52	38	49	35	50	36	47	35	52	28	49	25	35	21.5
100	2.66	3.2	48	35	45	32	45	32	42	32	47	24	44	21	29.9	20.1
155	3.26	-	45	-	42	-	42	-	39	-	42	-	39	-	26.2	-
200	3.86	-	42	-	39	-	39	-	36	-	37	-	34	-	23.5	-

\* EN 50288-2-2 (2014)/IEC 61156-6 (2010)

## Electrical characteristics at 20°C

Direct current resistance	Max.	145 Ω/km
Insulation resistance	Min.	5 GΩ x km
Mutual capacitance	Approx.	51 pF/m
Velocity of propagation (c)	Approx.	0.65
Propagation delay	Approx.	510 ns/100 m
Skew at 100 MHz	Approx.	15 ns/100 m
Charact. impedance	at 100 MHz	100 ± 5 Ω
Testing voltage U <sub>eff</sub>		1000 V
Operating voltage	Max.	125 V

## Thermal properties

For fixed installation	-20 °C up to +60 °C
For mobile operation	0°C up to +50°C

## Chemical characteristics

Free of hazardous substances according to RoHS 2011/65/EU

## Cable printing

KERPEN DATACOM Made in Germany **MegaLine®** D1-20 SF/U Flex  
4P Y "Batch number" "Metre marking"

## Colour code

WH-BU/BU, WH-OG/OG, WH-GN/GN, WH-BN/BN

## Certificates and approvals

Link performance: KERPEN DATACOM **MegaLine®** systems  
and other commercially available connector systems  
Test certificates: according to DIN 55350-18-4.2.1 or EN 10204  
Compliant with LVD (2014/35/EU): **CE**

Dimensions	Outer Ø approx.	Weight approx.	Copper sales factor*	Sheath colour	Order no.
	mm	kg/km	kg/km		
4P	5.5	33	21	◆ Light grey	LKD7KS50008xxxx
				◆ Colza yellow	LKD7KS50009xxxx
				◆ Turquoise green	LKD7KS50010xxxx
				◆ Sky blue	LKD7KS50011xxxx
				◆ Fire red	LKD7KS50012xxxx
				◆ Orange	LKD7KS50093xxxx

Packaging: xxxx Standard length: 0100 = 1000 m 0050 = 500 m 0000 = general \* See page 17: Definition of copper sales factor

# MegaLine® F10-130 S/F (L)2Y

Category 7<sub>A</sub>



Type KS-02YSCH(L)2Y 4x2xAWG 22/1 PIMF

## Benefits

- ▶ Better than category 7<sub>A</sub>
- ▶ Bandwidth 1300 MHz
- ▶ Excellent shielding characteristics
- ▶ for installation outdoors and in the ground
- ▶ PVP-GHMT
- ▶ RoHS and REACH conformity

## Construction for 4P

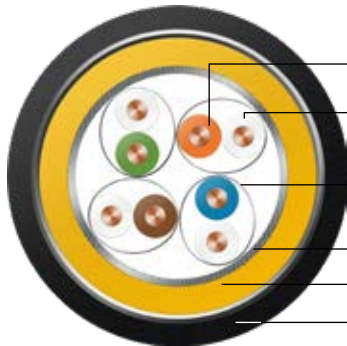

<b>Conductor</b>	Bare copper wire, AWG 22/1
<b>Insulation</b>	Foam PE, core Ø: Nominal value 1.6 mm
<b>Twisting element</b>	Pair
<b>Individual shielding</b>	Aluminium-bonded polyester foil, metal on the outside (PIMF)
<b>Twisting</b>	4 pairs
<b>Overall shielding</b>	Tinned copper wire braid
<b>Inner sheath</b>	halogen-free, flame-retardant compound
<b>Outer sheath</b>	AL-PE

## Fire behaviour

Halogen free	according to IEC 60754-1/2
Fire load (reference value)	3.04 MJ/m

## Performance

Better than Category 7 according to EN 50288 and IEC 61156  
excellent NEXT, low attenuation,  
excellent shielding characteristics (pairs and overall shielding),  
low skew, bandwidth (typical): 1300 MHz

## Applications

Installation cable for use in structured cabling according to ISO/IEC 11801 and EN 50173 (3rd edition).

Ideal for all applications of Classes D to F<sub>A</sub>, multimedia (video, data, voice) >10 GbE according to IEEE 802.3an, cable sharing, VoIP, PoE/PoE+/4PPoE  
For use outdoors and underground installation.

## Mechanical characteristics

Bending radius	During installation	8 x outer diameter (min.)
	After installation	4 x outer diameter (min.)
Tensile strength (max.)		130 N
Crush strength		2000 N/100 mm
Impact strength (number of shocks)		20

## Electromagnetic behaviour

Coupling resistance at 10 MHz (nom.)	5 mΩ/m
Screen attenuation (nom.)	70 dB
Coupling attenuation (nom.)	85 dB
Separating class according to EN 50174-2	d

## Security (fire behaviour)

<b>S</b>	<b>1</b> IEC 60332-2-2	<b>2</b> IEC-60332-1-2	<b>3</b> IEC-60332-3-24	<b>4</b> EFP Grade 1	<b>5</b> EFP Grade 2
----------	---------------------------	---------------------------	----------------------------	-------------------------	-------------------------

## Performance (cabling class, bandwidth)

<b>P</b>	<b>1</b> > Class E > 250 MHz	<b>2</b> > Class E <sub>A</sub> > 500 MHz	<b>3</b> > Class F > 600 MHz	<b>4</b> > Class F <sub>A</sub> > 1000 MHz	<b>5</b> > Class F <sub>A+</sub> > 1200 MHz
----------	------------------------------------	---	------------------------------------	--	---

## Industrial applications (ethernet, TV)

<b>I</b>	<b>1</b> > 100 MbE	<b>2</b> > 1 GbE	<b>3</b> Up to 10 GbE	<b>4</b> > 10 GbE	<b>5</b> > 10 GbE TV
----------	-----------------------	---------------------	--------------------------	----------------------	-------------------------

## Construction (conductor dimension, tensile strength)

<b>C</b>	<b>1</b> AWG 27	<b>2</b> AWG 26/25	<b>3</b> AWG 24	<b>4</b> AWG 23	<b>5</b> AWG 22
----------	--------------------	-----------------------	--------------------	--------------------	--------------------

## EMC (coupling attenuation)

<b>E</b>	<b>1</b> > 40 dB	<b>2</b> > 50 dB	<b>3</b> > 60 dB	<b>4</b> > 70 dB	<b>5</b> > 80 dB
----------	---------------------	---------------------	---------------------	---------------------	---------------------

### Electrical characteristics (HF) at 20°C

Frequency MHz	Attenuation dB/100 m		NEXT dB		PS-NEXT dB		ACR dB at 100 m		PS-ACR dB at 100 m		EL-FEXT dB at 100 m		PS-ELFEXT dB at 100 m		RL dB	
	Typ.	Cat. 7 max.*	Typ.	Cat. 7 max.*	Typ.	Cat. 7 max.*	Typ.	Cat. 7 max.*	Typ.	Cat. 7 max.*	Typ.	Cat. 7 max.*	Typ.	Cat. 7 max.*	Typ.	Cat. 7 max.*
1	1.7	2	105	80	102	77	104	78	101	75	105	80	102	77	27.1	23
10	4.5	5.7	105	80	102	77	101	74	98	71	108	74	105	71	35.2	25
100	15.4	18.5	105	72	102	69	90	54	87	51	93	54	90	51	38.9	20.1
200	22.9	26.8	105	68	102	65	83	41	80	38	85	48	82	45	36.6	18
250	26	30.2	105	66	102	63	79	36	76	33	82	46	79	43	35.3	17.3
500	35.9	44.1	100	62	97	59	64	18	61	15	70	40	67	37	29.4	17.3
600	40.4	48.9	95	61	92	58	55	12	52	9	63	38	60	35	26.6	17.3
700	44.6	-	95	-	92	-	50	-	47	-	60	-	57	-	25.8	-
800	47.7	-	93	-	90	-	45	-	42	-	57	-	54	-	25	-
900	51.6	-	90	-	87	-	38	-	35	-	53	-	50	-	23.6	-
1000	54.8	-	88	-	85	-	33	-	30	-	48	-	45	-	22.3	-
1100	56.9	-	87	-	84	-	30	-	27	-	44	-	41	-	21.4	-
1300	61.4	-	80	-	77	-	21	-	18	-	39	-	36	-	18.3	-

\* EN 50288-4-1 (2014)/IEC 61156-5 (2009)

### Electrical characteristics at 20°C

Direct current resistance	Max.	57.1 Ω/km
Insulation resistance	Min.	5 GΩ x km
Mutual capacitance	Approx.	40 pF/m
Capacitive coupling (e)	Approx.	1100 pF/km
Velocity of propagation (c)	Approx.	0.80
Propagation delay	Approx.	420 ns/100 m
Skew at 100 MHz	Approx.	5 ns/100 m
Charact. impedance	at 100 MHz	100 ± 5 Ω
Testing voltage U <sub>eff</sub>		1000 V
Operating voltage	Max.	125 V

### Thermal properties

For fixed installation	-25 °C up to +70 °C
For mobile operation	-10°C up to +50°C

### Chemical characteristics

Free of hazardous substances in accordance with RoHS 2011/65/EU,  
 UV resistance in accordance with UL 1581 and ISO 4892  
 Oil-resistant according to ICEA S-73-532 (60°C)

### Cable printing

#### Inner sheath ▶▶

KERPEN DATACOM Made in Germany **MegaLine®** F10-130 S/F 4P  
 H "CPR Class" "DoP no." "Batch number" "Metre marking"

#### Outer sheath ▶▶

KERPEN DATACOM Made in Germany **MegaLine** 10-130 S/F 4P  
 H(L)2Y "Batch number" "Metre marking"

### Certificates and approvals

Quality mark with production control: GHMT PVP  
 Link performance: KERPEN DATACOM **MegaLine®** systems  
 and other commercially available connector systems  
 Test certificates: according to DIN 55350-18-4.2.1 or EN 10204  
 Compliant with LVD (2014/35/EU): **CE**

Dimensions	Outer Ø approx.	Weight approx.	Copper sales factor*	Sheath colour	Order no.
	mm	kg/km	kg/km		
4P	12.0	150	45	◆ Jet black	LKD7KS7002Uxxxx

Packaging: xxxx

Standard length: 0100 = 1000 m 0000 = general

\* See page 17: Definition of copper sales factor

# MegaLine® F10-130 S/F QH

Category 7<sub>A</sub>



Type KS-02YSCHQH 4x2xAWG 22/1 PIMF

## Benefits

- ▶ Better than category 7<sub>A</sub>
- ▶ Bandwidth 1300 MHz
- ▶ Excellent shielding characteristics
- ▶ for installation in outdoor areas and in harsh environments
- ▶ PVP-GHMT
- ▶ RoHS and REACH conformity

## Construction for 4P

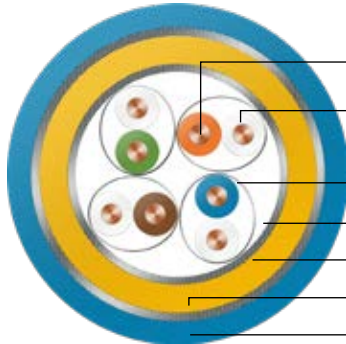

<b>Conductor</b>	Bare copper wire, AWG 22/1
<b>Insulation</b>	Foam PE, core Ø: Nominal value 1.6 mm
<b>Twisting element</b>	Pair
<b>Individual shielding</b>	Aluminium-bonded polyester foil, metal on the outside (PIMF)
<b>Twisting</b>	4 pairs
<b>Overall shielding</b>	Tinned copper wire braid
<b>Inner sheath</b>	halogen-free, flame-retardant compound
<b>Armouring</b>	Galvanised steel wire braiding
<b>Outer sheath</b>	halogen-free, flame-retardant compound

## Fire behaviour

Flame retardancy	according to IEC 60332-3-24
Halogen free	according to IEC 60754-1/2
Smoke density	according to IEC 61034-1/2
Fire load (reference value)	1.53 MJ/m

## Performance

Better than Category 7 according to EN 50288 and IEC 61156 excellent NEXT, low attenuation, excellent shielding characteristics (pairs and overall shielding), low skew, bandwidth (typical): 1300 MHz

## Applications

Installation cable for use in structured cabling according to ISO/IEC 11801 and EN 50173 (3rd edition). Ideal for all applications of Classes D to F<sub>A</sub>, multimedia (video, data, voice) >10 GbE according to IEEE 802.3an, cable sharing, VoIP, PoE/PoE+/4PPoE. For use indoors and outdoors (conditionally) and in harsh environments. With rodent protection.

## Mechanical characteristics

Bending radius	During installation	8 x outer diameter (min.)
	After installation	4 x outer diameter (min.)
Tensile strength (max.)		1400 N
Crush strength		3000 N/100 mm
Impact strength (number of shocks)		50

## Electromagnetic behaviour

Coupling resistance at 10 MHz (nom.)	5 mΩ/m
Screen attenuation (nom.)	70 dB
Coupling attenuation (nom.)	85 dB
Separating class according to EN 50174-2	d

## Security (fire behaviour)

<b>S</b>	1	2	3	4	5
	IEC 60332-2-2	IEC-60332-1-2	IEC-60332-3-24	EFP Grade 1	EFP Grade 2

## Performance (cabling class, bandwidth)

<b>P</b>	1	2	3	4	5
	> Class E	> Class E <sub>A</sub>	> Class F	> Class F <sub>A</sub>	> Class F <sub>A+</sub>
	> 250 MHz	> 500 MHz	> 600 MHz	> 1000 MHz	> 1200 MHz

## Industrial applications (ethernet, TV)

<b>I</b>	1	2	3	4	5
	> 100 MbE	> 1 GbE	Up to 10 GbE	> 10 GbE	> 10 GbE TV

## Construction (conductor dimension, tensile strength)

<b>C</b>	1	2	3	4	5
	AWG 27	AWG 26/25	AWG 24	AWG 23	AWG 22

## EMC (coupling attenuation)

<b>E</b>	1	2	3	4	5
	> 40 dB	> 50 dB	> 60 dB	> 70 dB	> 80 dB



### Electrical characteristics (HF) at 20°C

Frequency MHz	Attenuation dB/100 m		NEXT dB		PS-NEXT dB		ACR dB at 100 m		PS-ACR dB at 100 m		EL-FEXT dB at 100 m		PS-ELFEXT dB at 100 m		RL dB	
	Typ.	Cat. 7 max.*	Typ.	Cat. 7 max.*	Typ.	Cat. 7 max.*	Typ.	Cat. 7 max.*	Typ.	Cat. 7 max.*	Typ.	Cat. 7 max.*	Typ.	Cat. 7 max.*	Typ.	Cat. 7 max.*
1	1.7	2	105	80	102	77	104	78	101	75	105	80	102	77	27.1	23
10	4.5	5.7	105	80	102	77	101	74	98	71	108	74	105	71	35.2	25
100	15.4	18.5	105	72	102	69	90	54	87	51	93	54	90	51	38.9	20.1
200	22.9	26.8	105	68	102	65	83	41	80	38	85	48	82	45	36.6	18
250	26	30.2	105	66	102	63	79	36	76	33	82	46	79	43	35.3	17.3
500	35.9	44.1	100	62	97	59	64	18	61	15	70	40	67	37	29.4	17.3
600	40.4	48.9	95	61	92	58	55	12	52	9	63	38	60	35	26.6	17.3
700	44.6	-	95	-	92	-	50	-	47	-	60	-	57	-	25.8	-
800	47.7	-	93	-	90	-	45	-	42	-	57	-	54	-	25	-
900	51.6	-	90	-	87	-	38	-	35	-	53	-	50	-	23.6	-
1000	54.8	-	88	-	85	-	33	-	30	-	48	-	45	-	22.3	-
1100	56.9	-	87	-	84	-	30	-	27	-	44	-	41	-	21.4	-
1300	61.4	-	80	-	77	-	21	-	18	-	39	-	36	-	18.3	-

\* EN 50288-4-1 (2014)/IEC 61156-5 (2009)

### Electrical characteristics at 20°C

Direct current resistance	Max.	57.1 Ω/km
Insulation resistance	Min.	5 GΩ x km
Mutual capacitance	Approx.	40 pF/m
Capacitive coupling (e)	Approx.	1100 pF/km
Velocity of propagation (c)	Approx.	0.80
Propagation delay	Approx.	420 ns/100 m
Skew at 100 MHz	Approx.	5 ns/100 m
Charact. impedance	at 100 MHz	100 ± 5 Ω
Testing voltage U <sub>eff</sub>		1000 V
Operating voltage	Max.	125 V

### Thermal properties

For fixed installation	-20 °C up to +60 °C
For mobile operation	0°C up to +50°C

### Chemical characteristics

Free of hazardous substances according to RoHS 2011/65/EU

### Cable printing

#### Inner sheath ▶▶

KERPEN DATACOM Made in Germany **MegaLine®** F10-130 S/F 4P  
H "CPR Class" "DoP no." "Batch number" "Metre marking"

#### Outer sheath ▶▶

KERPEN DATACOM Made in Germany **MegaLine®** F10-130 S/F 4P  
HQH "Batch number" "Metre marking"

### Certificates and approvals

Quality mark with production control: GHMT PVP

Link performance: KERPEN DATACOM **MegaLine®** systems  
and other commercially available connector systems

Test certificates: according to DIN 55350-18-4.2.1 or EN 10204

Compliant with LVD (2014/35/EU): 

Dimensions	Outer Ø approx.	Weight approx.	Copper sales factor*	Sheath colour	Order no.
	mm	kg/km	kg/km		
4P	11.7	185	45	◆ Sky blue	LKD7KS7001Uxxxx

Packaging: xxxx

Standard length: 0100 = 1000 m 0000 = general

\* See page 17: Definition of copper sales factor

# MegaLine® F10-130 S/F Vö universal cable

Category 7<sub>A</sub>



Type KS-02YSCHVö 4x2xAWG 22/1 PIMF

## Benefits

- ▶ Better than category 7<sub>A</sub>
- ▶ Bandwidth 1300 MHz
- ▶ Excellent shielding characteristics
- ▶ reinforced outer sheath
- ▶ Universal cable
- ▶ PVP-GHMT
- ▶ RoHS and REACH conformity

## Construction for 4P

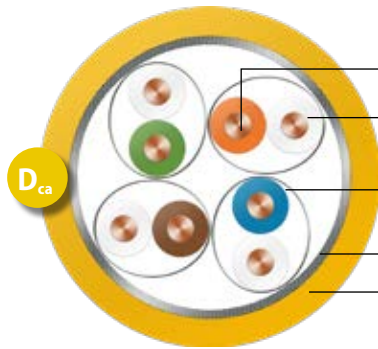

<b>Conductor</b>	Bare copper wire, AWG 22/1
<b>Insulation</b>	Foam PE, core Ø: Nominal value 1.6 mm
<b>Twisting element</b>	Pair
<b>Individual shielding</b>	Aluminium-bonded polyester foil, metal on the outside (PIMF)
<b>Twisting</b>	4 pairs
<b>Overall shielding</b>	Tinned copper wire braid
<b>Outer sheath</b>	halogen-free, flame-retardant compound

## Fire behaviour

Flame retardancy	according to IEC 60332-3-24
Halogen free	according to IEC 60754-1/2
Smoke density	according to IEC 61034-1/2
Fire load (reference value)	0.80 MJ/m

## Performance

Better than Category 7 according to EN 50288 and IEC 61156  
excellent NEXT, low attenuation,  
excellent shielding characteristics (pairs and overall shielding),  
low skew, bandwidth (typical): 1300 MHz

## Applications

Installation cable for use in structured building cabling according to ISO/IEC 11801 and EN 50173 (3rd edition). Ideal for all applications of Classes D to F<sub>A</sub> multimedia (video, data, voice) >10 GbE according to IEEE 802.3an, cable sharing, VoIP, PoE/PoE+/4PPoE. For use in harsh environments due to high-strength H sheath. UV-resistant, suitable for outdoor use.

## Mechanical characteristics

Bending radius	During installation	8 x outer diameter (min.)
	After installation	4 x outer diameter (min.)
Tensile strength (max.)		130 N
Crush strength		1000 N/100 mm
Impact strength (number of shocks)		10

## Electromagnetic behaviour

Coupling resistance at 10 MHz (nom.)	5 mΩ/m
Screen attenuation (nom.)	70 dB
Coupling damping (nom.) 85 dB	
Separating class according to EN 50174-2	d

## Security (fire behaviour)

S	1 IEC 60332-2-2	2 IEC-60332-1-2 E <sub>ca</sub> /D <sub>ca</sub>	3 IEC-60332-3-24 E <sub>ca</sub> /D <sub>ca</sub>	4 EFP Grade 1 C <sub>ca</sub>	5 EFP Grade 2 B2 <sub>ca</sub>
---	--------------------	--	---	-------------------------------------	--------------------------------------

## Performance (cabling class, bandwidth)

P	1 > Class E > 250 MHz	2 > Class E <sub>A</sub> > 500 MHz	3 > Class F > 600 MHz	4 > Class F <sub>A</sub> > 1000 MHz	5 > Class F <sub>A</sub> + > 1200 MHz
---	-----------------------------	--	-----------------------------	---	---

## Industrial applications (ethernet, TV)

I	1 > 100 MbE	2 > 1 GbE	3 Up to 10 GbE	4 > 10 GbE	5 > 10 GbE TV
---	----------------	--------------	-------------------	---------------	------------------

## Construction (conductor dimension, tensile strength)

C	1 AWG 27	2 AWG 26/25	3 AWG 24	4 AWG 23	5 AWG 22
---	-------------	----------------	-------------	-------------	-------------

## EMC (coupling attenuation)

E	1 > 40 dB	2 > 50 dB	3 > 60 dB	4 > 70 dB	5 > 80 dB
---	--------------	--------------	--------------	--------------	--------------

### Electrical characteristics (HF) at 20°C

Frequency MHz	Attenuation dB/100 m		NEXT dB		PS-NEXT dB		ACR dB at 100 m		PS-ACR dB at 100 m		EL-FEXT dB at 100 m		PS-ELFEXT dB at 100 m		RL dB	
	Typ.	Cat. 7 max.*	Typ.	Cat. 7 max.*	Typ.	Cat. 7 max.*	Typ.	Cat. 7 max.*	Typ.	Cat. 7 max.*	Typ.	Cat. 7 max.*	Typ.	Cat. 7 max.*	Typ.	Cat. 7 max.*
1	1.7	2	105	80	102	77	104	78	101	75	105	80	102	77	27.1	23
10	4.5	5.7	105	80	102	77	101	74	98	71	108	74	105	71	35.2	25
100	15.4	18.5	105	72	102	69	90	54	87	51	93	54	90	51	38.9	20.1
200	22.9	26.8	105	68	102	65	83	41	80	38	85	48	82	45	36.6	18
250	26	30.2	105	66	102	63	79	36	76	33	82	46	79	43	35.3	17.3
500	35.9	44.1	100	62	97	59	64	18	61	15	70	40	67	37	29.4	17.3
600	40.4	48.9	95	61	92	58	55	12	52	9	63	38	60	35	26.6	17.3
700	44.6	-	95	-	92	-	50	-	47	-	60	-	57	-	25.8	-
800	47.7	-	93	-	90	-	45	-	42	-	57	-	54	-	25	-
900	51.6	-	90	-	87	-	38	-	35	-	53	-	50	-	23.6	-
1000	54.8	-	88	-	85	-	33	-	30	-	48	-	45	-	22.3	-
1100	56.9	-	87	-	84	-	30	-	27	-	44	-	41	-	21.4	-
1300	61.4	-	80	-	77	-	21	-	18	-	39	-	36	-	18.3	-

\* EN 50288-4-1 (2014)/IEC 61156-5 (2009)

### Electrical characteristics at 20°C

Direct current resistance	Max.	57.1 Ω/km
Insulation resistance	Min.	5 GΩ x km
Mutual capacitance	Approx.	40 pF/m
Capacitive coupling (e)	Approx.	1100 pF/km
Velocity of propagation (c)	Approx.	0.77
Propagation delay	Approx.	420 ns/100 m
Skew at 100 MHz	Approx.	5 ns/100 m
Charact. impedance	at 100 MHz	100 ± 5 Ω
Testing voltage U <sub>eff</sub>		1000 V
Operating voltage	Max.	125 V

### Thermal properties

For fixed installation	-20 °C up to +70 °C
For mobile operation	0°C up to +50°C

### Chemical characteristics

Free from hazardous substances in accordance with RoHS 2011/65/EU,  
oil resistance in accordance with ICEA S-73-532 (60°C)  
UV resistance according to UL 1581 and ISO 4892  
Microbe-resistant according to DIN VDE 0282

### Cable printing

KERPEN DATACOM Made in Germany **MegaLine®** F10-130 S/F  
4P U 25G 4PPoE "CPR Class" "DoP no." "Batch number" "Metre marking"

### Certificates and approvals

Quality mark with production control: GHMT PVP  
Link performance: KERPEN DATACOM **MegaLine®** systems  
and other commercially available connector systems  
Test certificates: according to DIN 55350-18-4.2.1 or EN 10204  
Compliant with LVD (2014/35/EU): **CE**

Dimensions	Outer Ø approx.	Weight approx.	Copper sales factor*	CPR Class	DoP no.	Sheath colour	Order no.
	mm	kg/km	kg/km				
4P	8.8	84	45	D <sub>ca</sub> s2 d2 a1	CDESK0000046	◆ Colza yellow	LKD7KS70089xxxx

Packaging: xxxx

Standard length: 0100 = 1000 m 0050 = 500 m 0000 = general

\* See page 17: Definition of copper sales factor

# MegaLine® F6-90 S/F Vö universal cable

## Category 7<sub>A</sub>



### Benefits

- ▶ Better than category 7
- ▶ Bandwidth 1000 MHz
- ▶ Excellent shielding characteristics
- ▶ reinforced outer sheath
- ▶ Universal cable
- ▶ PVP-GHMT
- ▶ RoHS and REACH conformity

Type KS-02YSCHV 4x2xAWG 23/1 PIMF

### Construction for 4P

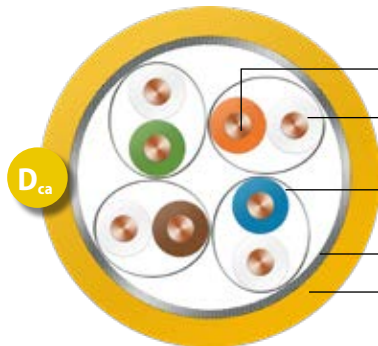

<b>Conductor</b>	Bare copper wire, AWG 23/1
<b>Insulation</b>	Foam PE, core Ø: Nominal value 1.4 mm
<b>Twisting element</b>	Pair
<b>Individual shielding</b>	Aluminium-bonded polyester foil, metal on the outside (PiMF)
<b>Twisting</b>	4 pairs
<b>Overall shielding</b>	Tinned copper wire braid
<b>Outer sheath</b>	halogen-free, flame-retardant compound

### Fire behaviour

Flame retardancy	according to IEC 60332-3-24
Halogen free	according to IEC 60754-1/2
Smoke density	according to IEC 61034-1/2
Fire load (reference value)	0.76 MJ/m

### Performance

Better than Category 7 according to EN 50288 and IEC 61156 excellent NEXT, low attenuation, excellent shielding characteristics (pairs and overall shielding), low skew, bandwidth (typical): 1000 MHz

### Applications

Installation cable for use in structured building cabling according to ISO/IEC 11801 and EN 50173 (3rd edition). Ideal for all applications of Classes D to F<sub>A</sub> multimedia (video, data, voice) >10 GbE according to IEEE 802.3an, cable sharing, VoIP, PoE/PoE+/4PPoE. For use in harsh environments due to high-strength H sheath. UV-resistant, suitable for outdoor use.

### Mechanical characteristics

Bending radius	During installation	8 x outer diameter (min.)
	After installation	4 x outer diameter (min.)
Tensile strength (max.)		130 N
Crush strength		1000 N/100 mm
Impact strength (number of shocks)		10

### Electromagnetic behaviour

Coupling resistance at 10 MHz (nom.)	5 mΩ/m
Screen attenuation (nom.)	70 dB
Coupling attenuation (nom.)	85 dB
Separating class according to EN 50174-2	d

### Security (fire behaviour)

S	1 IEC 60332-2-2	2 IEC-60332-1-2 E <sub>ca</sub> /D <sub>ca</sub>	3 IEC-60332-3-24 E <sub>ca</sub> /D <sub>ca</sub>	4 EFP Grade 1 C <sub>ca</sub>	5 EFP Grade 2 B2 <sub>ca</sub>
---	--------------------	--	---	-------------------------------------	--------------------------------------

### Performance (cabling class, bandwidth)

P	1 > Class E > 250 MHz	2 > Class E <sub>A</sub> > 500 MHz	3 > Class F > 600 MHz	4 > Class F <sub>A</sub> > 1000 MHz	5 > Class F <sub>A</sub> + > 1200 MHz
---	-----------------------------	--	-----------------------------	---	---

### Industrial applications (ethernet, TV)

I	1 > 100 MbE	2 > 1 GbE	3 Up to 10 GbE	4 > 10 GbE	5 > 10 GbE TV
---	----------------	--------------	-------------------	---------------	------------------

### Construction (conductor dimension, tensile strength)

C	1 AWG 27	2 AWG 26/25	3 AWG 24	4 AWG 23	5 AWG 22
---	-------------	----------------	-------------	-------------	-------------

### EMC (coupling attenuation)

E	1 > 40 dB	2 > 50 dB	3 > 60 dB	4 > 70 dB	5 > 80 dB
---	--------------	--------------	--------------	--------------	--------------

### Electrical characteristics (HF) at 20°C

Frequency MHz	Attenuation dB/100 m		NEXT dB		PS-NEXT dB		ACR dB at 100 m		PS-ACR dB at 100 m		EL-FEXT dB at 100 m		PS-ELFEXT dB at 100 m		RL dB	
	Typ.	Cat. 7 max.*	Typ.	Cat. 7 max.*	Typ.	Cat. 7 max.*	Typ.	Cat. 7 max.*	Typ.	Cat. 7 max.*	Typ.	Cat. 7 max.*	Typ.	Cat. 7 max.*	Typ.	Cat. 7 max.*
1	1.9	2	102	80	99	77	101	78	98	75	109	80	106	77	29	23
10	4.8	5.7	102	80	99	77	98	74	95	71	108	74	105	71	28	25
100	16.4	18.5	102	72	99	69	86	54	83	51	93	54	90	51	27	20.1
200	24.5	26.8	102	68	99	65	78	41	75	38	85	48	82	45	25	18
250	27.8	30.2	102	66	99	63	75	36	72	33	82	46	79	43	24	17.3
450	36.1	41.6	97	63	94	60	61	21	58	18	72	41	69	38	22	17.3
500	38.2	44.1	97	62	94	59	59	18	56	15	68	40	65	37	21	17.3
600	42.9	48.9	92	61	89	58	49	12	46	9	62	38	59	35	20	17.3
700	47.7	–	92	–	89	–	44	–	41	–	59	–	56	–	19	–
800	50.8	–	90	–	87	–	39	–	36	–	56	–	53	–	18	–
900	55.1	–	85	–	82	–	30	–	27	–	52	–	49	–	17	–
1000	58.0	–	80	–	77	–	22	–	19	–	42	–	39	–	15	–

\* EN 50288-4-1 (2014)/IEC 61156-5 (2009)

### Electrical characteristics at 20°C

Direct current resistance	Max.	75 Ω/km
Insulation resistance	Min.	5 GΩ x km
Mutual capacitance	Approx.	42 pF/m
Capacitive coupling (e)	Approx.	1100 pF/km
Velocity of propagation (c)	Approx.	0.79
Propagation delay	Approx.	420 ns/100 m
Skew at 100 MHz	Approx.	5 ns/100 m
Charact. impedance	at 100 MHz	100 ± 5 Ω
Testing voltage U <sub>eff</sub>		1000 V
Operating voltage	Max.	125 V

### Thermal properties

For fixed installation	-20 °C up to +70 °C
For mobile operation	0°C up to +50°C

### Chemical characteristics

Free from hazardous substances in accordance with RoHS 2011/65/EU,  
oil resistance in accordance with ICEA S-73-532 (60°C)  
UV resistance according to UL 1581 and ISO 4892  
Microbe-resistant according to DIN VDE 0282

### Cable printing

KERPEN DATACOM Made in Germany **MegaLine®** F6-90 S/F 4P U 25G 4PPoP "CPR Class" "DoP no." "Batch number" "Metre marking"

### Colour code

WH/BU, WH/OG, WH/GN, WH/NBN

### Certificates and approvals

Quality mark with production control: GHMT PVP  
Link performance: KERPEN DATACOM **MegaLine®** systems and other commercially available connector systems  
Test certificates: according to DIN 55350-18-4.2.1 or EN 10204  
Compliant with LVD (2014/35/EU): **CE**  
Compliant with Construction Products Regulation (EU/305/2011): **CE**

Dimensions	Outer Ø approx.	Weight approx.	Copper sales factor*	CPR Class	DoP no.	Sheath colour	Order no.
	mm	kg/km	kg/km				
4P	7.9	65	35	D <sub>ca</sub> s2 d2 a1	CDESK0000046	◆ Colza yellow	LKD7KS70711xxxx

Packaging: xxxx

Standard length: 0100 = 1000 m 0050 = 500 m 0000 = general

\* See page 17: Definition of copper sales factor

# MegaLine® F10-115 S/F V

Category 7<sub>A</sub>



Type KS-02YSCHV 4x2xAWG 23/1 PIMF

## Benefits

- ▶ Better than category 7<sub>A</sub>
- ▶ Bandwidth 1200 MHz
- ▶ Excellent shielding characteristics
- ▶ reinforced outer sheath
- ▶ PVP-GHMT
- ▶ RoHS and REACH conformity

## Construction for 4P

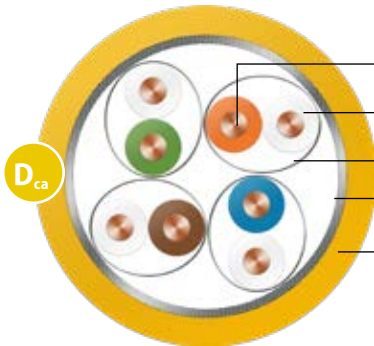

<b>Conductor</b>	Bare copper wire, AWG 23/1
<b>Insulation</b>	Foam PE, core Ø: Nominal value 1.4 mm
<b>Twisting element</b>	Pair
<b>Twisting</b>	4 pairs
<b>Overall shielding</b>	Tinned copper wire braid
<b>Outer sheath</b>	Halogen-free, flame-retardant compound, wall thickness 1.0 mm

## Fire behaviour

Flame retardancy	according to IEC 60332-3-24
Halogen free	according to IEC 60754-1/2
Smoke density	according to IEC 61034-1/2
Fire load (reference value)	0.7 MJ/m

## Performance

Better than Category 7 according to EN 50288 and IEC 61156 excellent NEXT, excellent shielding characteristics (pairs and overall shielding), low skew, bandwidth (typical): 1150 MHz

## Applications

Installation cable for use in structured building cabling according to ISO/IEC 11801 and EN 50173 (3rd edition). Ideal for all applications of Classes D to F<sub>A</sub>, multimedia (video, data, voice) >10 GbE according to IEEE 802.3an, cable sharing, VoIP, PoE/PoE+/4PPoE.

Suitable for use in harsh environments thanks to high-strength H sheath.

## Mechanical characteristics

Bending radius	During installation	8 x outer diameter (min.)
	After installation	4 x outer diameter (min.)
Tensile strength (max.)		110 N
Crush strength		1000 N/100 mm
Impact strength (number of shocks)		10

## Electromagnetic behaviour

Coupling resistance at 10 MHz (nom.)	5 mΩ/m
Screen attenuation (nom.)	70 dB
Coupling damping (nom.) 85 dB	
Separating class according to EN 50174-2	d

## Security (fire behaviour)

S	1 IEC 60332-2-2	2 IEC-60332-1-2 E <sub>ca</sub> /D <sub>ca</sub>	3 IEC-60332-3-24 E <sub>ca</sub> /D <sub>ca</sub>	4 EFP Grade 1 C <sub>ca</sub>	5 EFP Grade 2 B2 <sub>ca</sub>
---	--------------------	--	---	-------------------------------------	--------------------------------------

## Performance (cabling class, bandwidth)

P	1 > Class E > 250 MHz	2 > Class E <sub>A</sub> > 500 MHz	3 > Class F > 600 MHz	4 > Class F <sub>A</sub> > 1000 MHz	5 > Class F <sub>A</sub> + > 1200 MHz
---	-----------------------------	--	-----------------------------	---	---

## Industrial applications (ethernet, TV)

I	1 > 100 MbE	2 > 1 GbE	3 Up to 10 GbE	4 > 10 GbE	5 > 10 GbE TV
---	----------------	--------------	-------------------	---------------	------------------

## Construction (conductor dimension, tensile strength)

C	1 AWG 27	2 AWG 26/25	3 AWG 24	4 AWG 23	5 AWG 22
---	-------------	----------------	-------------	-------------	-------------

## EMC (coupling attenuation)

E	1 > 40 dB	2 > 50 dB	3 > 60 dB	4 > 70 dB	5 > 80 dB
---	--------------	--------------	--------------	--------------	--------------

### Electrical characteristics (HF) at 20°C

Frequency MHz	Attenuation dB/100 m		NEXT dB		PS-NEXT dB		ACR dB at 100 m		PS-ACR dB at 100 m		EL-FEXT dB at 100 m		PS-ELFEXT dB at 100 m		RL dB	
	Typ.	Cat. 7 <sub>A</sub> max.*	Typ.	Cat. 7 <sub>A</sub> min.*	Typ.	Cat. 7 <sub>A</sub> min.*	Typ.	Cat. 7 <sub>A</sub> min.*	Typ.	Cat. 7 <sub>A</sub> min.*	Typ.	Cat. 7 <sub>A</sub> min.*	Typ.	Cat. 7 <sub>A</sub> min.*	Typ.	Cat. 7 <sub>A</sub> min.*
1	1.9	2.1	105	78	102	75	104	75.9	101	72.9	98	78	95	75	26.6	20
10	4.8	5.8	105	78	102	75	101	72.2	98	69.2	103	75.3	100	72.3	35.3	25
100	16.3	18.5	105	75.4	102	72.4	89	56.9	86	53.9	89	55.3	86	52.3	39.6	20.1
200	24.3	26.5	105	70.9	102	67.9	81	44.4	78	41.4	82	49.3	79	46.3	36	18
250	27.5	29.7	105	69.4	102	66.4	78	39.7	75	36.7	79	47.3	76	44.3	34	17.3
500	37.9	42.8	100	64.9	97	61.9	62	22.2	59	19.2	67	41.3	64	38.3	29	17.3
600	42.4	47.1	95	63.7	92	60.7	53	16.6	50	13.6	60	39.7	57	36.7	25.4	17.3
700	47.2	51.1	95	62.7	92	59.7	48	11.6	45	8.6	57	38.4	54	35.4	24.6	16.6
800	50.3	54.9	93	61.9	90	58.9	43	6.9	40	3.9	53	37.2	50	34.2	23.5	16.1
900	54.6	58.5	90	61.1	87	58.1	35	2.6	32	-0.4	49	36.2	46	33.2	22.6	15.5
1000	58	61.9	88	60.4	85	57.4	30	-1.5	27	-4.5	44	35.3	41	32.3	21.5	15.1
1150	61.9	-	86	-	83	-	25	-	22	-	39	-	36	-	20.6	-
1200	64	-	85	-	82	-	21	-	18	-	35	-	32	-	19	-

\* EN 50288-9-1 (2013)/IEC 61156-5 (2009)

### Electrical characteristics at 20°C

Direct current resistance	Max.	75 Ω/km
Insulation resistance	Min.	5 GΩ x km
Mutual capacitance	Approx.	42 pF/m
Capacitive coupling (e)	Approx.	1100 pF/km
Velocity of propagation (c)	Approx.	0.80
Propagation delay	Approx.	420 ns/100 m
Skew at 100 MHz	Approx.	5 ns/100 m
Charact. impedance	at 100 MHz	100 ± 5 Ω
Testing voltage U <sub>eff</sub>		1000 V
Operating voltage	Max.	125 V

### Thermal properties

For fixed installation	-20 °C up to +60 °C
For mobile operation	0°C up to +50°C

### Chemical characteristics

Free of hazardous substances according to RoHS 2011/65/EU

### Cable printing

KERPEN DATACOM Made in Germany **MegaLine®** F10-115 S/F 4P  
HV "CPR Class" "DoP no." "Batch number" "Metre marking"

### Certificates and approvals

Quality mark with production control: GHMT PVP  
Link performance: KERPEN DATACOM **MegaLine®** systems  
and other commercially available connector systems  
Test certificates: according to DIN 55350-18-4.2.1 or EN 10204  
Compliant with LVD (2014/35/EU): **CE**

Dimensions	Outer Ø approx.	Weight approx.	Copper sales factor*	CPR Class	DoP no.	Sheath colour	Order no.
	mm	kg/km	kg/km				
4P	8.1	77	37	D <sub>ca</sub> s2 d2 a1	CDESK0000045	◆ Colza yellow	LKD7KS70049xxxx

Packaging: xxxx

Standard length: 0100 = 1000 m 0050 = 500 m 0000 = general

\* See page 17: Definition of copper sales factor

# MegaLine® F6-90 S/F 2Y

## Category 7



Type KS-02YSC2Y 4x2xAWG 23/1 PIMF

### Benefits

- ▶ Better than category 7
- ▶ Bandwidth 1000 MHz
- ▶ Excellent shielding characteristics
- ▶ for installation outdoors and in the ground
- ▶ PVP-GHMT
- ▶ RoHS and REACH conformity

### Construction for 4P

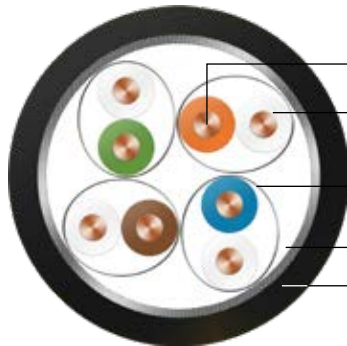

<b>Conductor</b>	Bare copper wire, AWG 23/1
<b>Insulation</b>	Foam PE, core Ø: Nominal value 1.4 mm
<b>Twisting element</b>	Pair
<b>Individual shielding</b>	Aluminium-bonded polyester foil, metal on the outside (PiMF)
<b>Twisting</b>	4 pairs
<b>Overall shielding</b>	Tinned copper wire braid
<b>Outer sheath</b>	PE

### Fire behaviour

Halogen free according to IEC 60754-1/2

### Performance

Better than Category 7 according to EN 50288 and IEC 61156, excellent NEXT, excellent shielding characteristics (pairs and overall shielding), low skew, bandwidth (typical): 900 MHz

### Applications

Installation cable for use in structured cabling according to ISO/IEC 11801 and EN 50173 (3rd edition). Ideal for all applications of Classes D to F, multimedia (video, data, voice) > 10 GbE according to IEEE 802.3an, cable sharing, VoIP, PoE/PoE+/4PPoE.

For use outdoors and underground installation.

### Mechanical characteristics

Bending radius	During installation	8 x outer diameter (min.)
	After installation	4 x outer diameter (min.)
Tensile strength (max.)		110 N
Crush strength		2000 N/100 mm
Impact strength (number of shocks)		20

### Electromagnetic behaviour

Coupling resistance at 10 MHz (nom.)	5 mΩ/m
Screen attenuation (nom.)	70 dB
Coupling attenuation (nom.)	85 dB
Separating class according to EN 50174-2	d

### Security (fire behaviour)

<b>S</b>	1 IEC 60332-2-2	2 IEC-60332-1-2	3 IEC-60332-3-24	4 EFP Grade 1	5 EFP Grade 2
----------	--------------------	--------------------	---------------------	------------------	------------------

### Performance (cabling class, bandwidth)

<b>P</b>	1 > Class E > 250 MHz	2 > Class E <sub>A</sub> > 500 MHz	3 > Class F > 600 MHz	4 > Class F <sub>A</sub> > 1000 MHz	5 > Class F <sub>A</sub> + > 1200 MHz
----------	-----------------------------	--	-----------------------------	---	---

### Industrial applications (ethernet, TV)

<b>I</b>	1 > 100 MbE	2 > 1 GbE	3 Up to 10 GbE	4 > 10 GbE	5 > 10 GbE TV
----------	----------------	--------------	-------------------	---------------	------------------

### Construction (conductor dimension, tensile strength)

<b>C</b>	1 AWG 27	2 AWG 26/25	3 AWG 24	4 AWG 23	5 AWG 22
----------	-------------	----------------	-------------	-------------	-------------

### EMC (coupling attenuation)

<b>E</b>	1 > 40 dB	2 > 50 dB	3 > 60 dB	4 > 70 dB	5 > 80 dB
----------	--------------	--------------	--------------	--------------	--------------



### Electrical characteristics (HF) at 20°C

Frequency MHz	Attenuation dB/100 m		NEXT dB		PS-NEXT dB		ACR dB at 100 m		PS-ACR dB at 100 m		EL-FEXT dB at 100 m		PS-ELFEXT dB at 100 m		RL dB	
	Typ.	Cat. 7 max.*	Typ.	Cat. 7 min.*	Typ.	Cat. 7 min.*	Typ.	Cat. 7 min.*	Typ.	Cat. 7 min.*	Typ.	Cat. 7 min.*	Typ.	Cat. 7 min.*	Typ.	Cat. 7 min.*
1	1.9	2	102	80	99	77	101	78	98	75	109	80	106	77	25.4	23
10	4.8	5.7	102	80	99	77	98	74	95	71	108	74	105	71	31.1	25
100	16.4	18.5	102	72	99	69	86	54	83	51	93	54	90	51	33.2	20.1
200	24.5	26.8	102	68	99	65	78	41	75	38	85	48	82	45	33.2	18
250	27.8	30.2	102	66	99	63	75	36	72	33	82	46	79	43	33.4	17.3
450	36.1	44.6	97	63	94	60	61	21	58	18	72	41	69	38	31.4	17.3
500	38.2	44.1	97	62	94	59	59	18	56	15	68	40	65	37	30.5	17.3
600	42.9	48.9	92	61	89	58	49	12	46	9	62	38	59	35	27.6	17.3
700	47.7	-	92	-	89	-	44	-	41	-	59	-	56	-	26.2	-
800	50.8	-	90	-	87	-	39	-	36	-	56	-	53	-	23.9	-
900	55.1	-	85	-	82	-	30	-	27	-	52	-	49	-	21.7	-

\* EN 50288-4-1 (2014)/IEC 61156-5 (2009)

### Electrical characteristics at 20°C

Direct current resistance	Max.	75 Ω/km
Insulation resistance	Min.	5 GΩ x km
Mutual capacitance	Approx.	42 pF/m
Capacitive coupling (e)	Approx.	1100 pF/km
Velocity of propagation (c)	Approx.	0.79
Propagation delay	Approx.	420 ns/100 m
Skew at 100 MHz	Approx.	5 ns/100 m
Charact. impedance	at 100 MHz	100 ± 5 Ω
Testing voltage U <sub>eff</sub>		1000 V
Operating voltage	Max.	125 V

### Thermal properties

For fixed installation	-25 °C up to +70 °C
For mobile operation	-10°C up to +50°C

### Chemical characteristics

Free of hazardous substances according to RoHS 2011/65/EU  
 UV resistance according to UL 1581 and ISO 4892  
 Free of lacquer-wetting substances (e.g. silicon oil)  
 Oil-resistant according to ICEA S-73-532 (60°C)

### Cable printing

KERPEN DATACOM F6-90 S/F 4P 2Y Made in Germany **MegaLine®**  
 "Batch number" "Metre marking"

### Certificates and approvals

Quality mark with production control: GHMT PVP  
 Link performance: KERPEN DATACOM **MegaLine®** systems  
 and other commercially available connector systems  
 Test certificates: according to DIN 55350-18-4.2.1 or EN 10204  
 Compliant with LVD (2014/35/EU): **CE**

Dimensions	Outer Ø approx.	Weight approx.	Copper sales factor*	CPR Class	DoP no.	Sheath colour	Order no.
	mm	kg/km	kg/km				
4P	9.0	70	35	Fca	CDESK0000026	◆ Jet black	LKD7KS70169xxxx

Packaging: xxxx

Standard length: 0100 = 1000 m 0000 = general

\* See page 17: Definition of copper sales factor

# MegaLine® D1-20 SF/U 2Y

## Category 5



Type KS-02YS(ST+C)H2Y 4x2xAWG 24/1

### Benefits

- ▶ Better than category 5
- ▶ Bandwidth 200 MHz
- ▶ good shielding characteristics
- ▶ for installation outdoors and in the ground
- ▶ RoHS and REACH conformity

### Construction for 4P

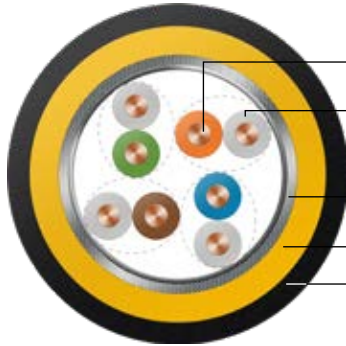

<b>Conductor</b>	Bare copper wire, AWG 24/1
<b>Insulation</b>	Foam PE, core Ø: Nominal value 1.1 mm
<b>Twisting element</b>	Pair
<b>Twisting</b>	4 pairs
<b>Overall shielding</b>	Aluminium-bonded polyester foil and Tinned copper wire braid
<b>Inner sheath</b>	halogen-free, flame-retardant compound
<b>Outer sheath</b>	PE

### Fire behaviour

Halogen free	according to IEC 60754-1/2
Fire load (reference value)	1.88 MJ/m

### Performance

Better than Category 5 according to EN 50288 and IEC 61156  
Excellent shielding characteristics  
Bandwidth (typical): 200 MHz

### Applications

Installation cable for use in structured cabling according to ISO/IEC 11801 and EN 50173 (3rd edition). Ideal for all applications of Classes D up to 1 GbE according to IEEE 802.3ab, cable sharing, VoIP, PoE/PoE+/4PPoE. For use outdoors and underground installation.

### Mechanical characteristics

Bending radius	During installation	8 x outer diameter (min.)
	After installation	4 x outer diameter (min.)
Tensile strength (max.)		85 N
Crush strength		3000 N/100 mm
Impact strength (number of shocks)		50

### Electromagnetic behaviour

Coupling resistance at 10 MHz (nom.)	10 mΩ/m
Screen attenuation (nom.)	55 dB
Coupling attenuation (nom.)	70 dB
Separating class according to EN 50174-2	c

### Security (fire behaviour)

<b>S</b>	<b>1</b>	<b>2</b>	<b>3</b>	<b>4</b>	<b>5</b>
	IEC 60332-2-2	IEC-60332-1-2	IEC-60332-3-24	EFP Grade 1	EFP Grade 2

### Performance (cabling class, bandwidth)

<b>P</b>	<b>1</b>	<b>2</b>	<b>3</b>	<b>4</b>	<b>5</b>
	> Class E	> Class E <sub>x</sub>	> Class F	> Class F <sub>x</sub>	> Class F <sub>x+</sub>
	> 250 MHz	> 500 MHz	> 600 MHz	> 1000 MHz	> 1200 MHz

### Industrial applications (ethernet, TV)

<b>I</b>	<b>1</b>	<b>2</b>	<b>3</b>	<b>4</b>	<b>5</b>
	> 100 MbE	> 1 GbE	Up to 10 GbE	> 10 GbE	> 10 GbE TV

### Construction (conductor dimension, tensile strength)

<b>C</b>	<b>1</b>	<b>2</b>	<b>3</b>	<b>4</b>	<b>5</b>
	AWG 27	AWG 26/25	AWG 24	AWG 23	AWG 22

### EMC (coupling attenuation)

<b>E</b>	<b>1</b>	<b>2</b>	<b>3</b>	<b>4</b>	<b>5</b>
	> 40 dB	> 50 dB	> 60 dB	> 70 dB	> 80 dB

### Electrical characteristics (HF) at 20°C

Frequency MHz	Attenuation dB/100 m		NEXT dB		PS-NEXT dB		ACR dB at 100 m		PS-ACR dB at 100 m		EL-FEXT dB at 100 m		PS-ELFEXT dB at 100 m		RL dB	
	Typ.	Cat. 5 max.*	Typ.	Cat. 5 min.*	Typ.	Cat. 5 min.*	Typ.	Cat. 5 min.*	Typ.	Cat. 5 min.*	Typ.	Cat. 5 min.*	Typ.	Cat. 5 min.*	Typ.	Cat. 5 min.*
1	2	2.1	75	65	72	62	73	63	70	60	89	64	86	61	24.8	-
4	3.1	4	69	56	66	53	66	52	63	49	84	52	81	49	28.6	23
10	5.1	6.3	62	50	59	47	57	44	54	41	76	44	73	41	33.3	25
16	7	8	58	47	55	44	51	39	48	36	70	40	67	37	34.3	25
31.25	9.7	11.4	53	43	50	40	44	31	41	28	63	34	60	31	33.9	23.6
62.5	13.2	16.5	49	38	46	35	36	22	33	19	58	28	55	25	31.3	21.5
100	17.6	21.3	45	35	42	32	28	14	25	11	52	24	49	21	27.7	20.1
155	22.3	-	42	-	39	-	20	-	17	-	49	-	46	-	24.7	-
200	26.5	-	40	-	37	-	14	-	11	-	45	-	42	-	22.4	-

\* EN 50288-4-1 (2014)/IEC 61156-5 (2009)

### Electrical characteristics at 20°C

Direct current resistance	Max.	95 Ω/km
Insulation resistance	Min.	5 GΩ x km
Mutual capacitance	Approx.	45 pF/m
Capacitive coupling (e)	Approx.	1100 pF/km
Velocity of propagation (c)	Approx.	0.75
Propagation delay	Approx.	440 ns/100 m
Skew at 100 MHz	Approx.	15 ns/100 m
Charact. impedance	at 100 MHz	100 ± 5 Ω
Testing voltage U <sub>eff</sub>		1000 V
Operating voltage	Max.	125 V

### Thermal properties

For fixed installation	-25 °C up to +70 °C
For mobile operation	-10°C up to +50°C

### Chemical characteristics

Free of hazardous substances according to RoHS 2011/65/EU

UV resistance according to UL 1581 and ISO 4892

Oil-resistant according to ICEA S-73-532 (60°C)

### Cable printing

#### Inner sheath ▶▶

KERPEN DATACOM Made in Germany **MegaLine®** D1-20 SF/U 4P  
H "CPR Class" "DoP no." "Batch number" "Metre marking"

#### Outer sheath ▶▶

KERPEN DATACOM Made in Germany **MegaLine®** D1-20 SF/U 4P  
H2Y "Batch number" "Metre marking"

### Certificates and approvals

Link performance: KERPEN DATACOM **MegaLine®** systems  
and other commercially available connector systems

Test certificates: according to DIN 55350-18-4.2.1 or EN 10204

Compliant with LVD (2014/35/EU): **CE**

Dimensions	Outer Ø approx.	Weight approx.	Copper sales factor*	Sheath colour	Order no.
	mm	kg/km	kg/km		
4P	8.8	70	26	◆ Jet black	LKD7KS5001Uxxxx

Packaging: xxxx

Standard length: 0100 = 1000 m 0000 = general

\* See page 17: Definition of copper sales factor

# MegaLine® F10-120 S/F 11Y Flex

Category 7<sub>A</sub>



Type KS-02YSC11Y 4x2xAWG 26/7 PIMF

## Benefits

- ▶ Better than category 7
- ▶ Bandwidth 1200 MHz
- ▶ Excellent shielding characteristics
- ▶ for installation in outdoor areas and in harsh environments
- ▶ RoHS and REACH conformity

## Construction for 4P

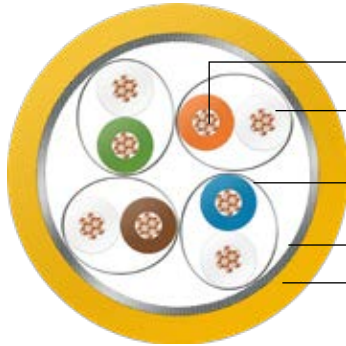

<b>Conductor</b>	Bare copper wire, AWG 26/7
<b>Insulation</b>	Foam PE, core Ø: Nominal value 1.05 mm
<b>Twisting element</b>	Pair
<b>Individual shielding</b>	Aluminium-bonded polyester foil, metal on the outside (PIMF)
<b>Twisting</b>	4 pairs
<b>Overall shielding</b>	Tinned copper wire braid
<b>Outer sheath</b>	PUR

## Fire behaviour

Flame retardancy	according to IEC 60332-2-2
Halogen-free	according to 60754-1/2
Smoke density	according to IEC 61034-1/2
Fire load (reference value)	0.55 MJ/m

## Performance

Better than Category 7 according to EN 50288 and IEC 61156 excellent NEXT, low attenuation, excellent shielding characteristics (pairs and overall shielding), low skew, bandwidth (typical): 1200 MHz

## Applications

Connection cables and patch cords for use in structured building cabling according to ISO/IEC 11801 and EN 50173 (3rd edition). Ideal for all applications of Classes D to F<sub>A</sub>, multimedia (TV, video, data voice) > 10 GbE according to IEEE 802.3an, cable sharing, VoIP, PoE/PoE+/4PPoE. For use in harsh environments due to very rugged PUR sheath.

## Mechanical characteristics

Bending radius in operation	5 x outer diameter (min.)
Tensile strength (max.)	60 N

## Electromagnetic behaviour

Coupling resistance at 10 MHz (nom.)	5 mΩ/m
Screen attenuation (nom.)	60 dB
Coupling attenuation (nom.)	85 dB
Separating class according to EN 50174-2	d

## Security (fire behaviour)

<b>S</b>	1 IEC 60332-2-2	2 IEC-60332-1-2	3 IEC-60332-3-24	4 EFP Grade 1	5 EFP Grade 2
----------	--------------------	--------------------	---------------------	------------------	------------------

## Performance (cabling class, bandwidth)

<b>P</b>	1 > Class E > 250 MHz	2 > Class E <sub>A</sub> > 500 MHz	3 > Class F > 600 MHz	4 > Class F <sub>A</sub> > 1000 MHz	5 > Class F <sub>A</sub> + > 1200 MHz
----------	-----------------------------	--	-----------------------------	---	---

## Industrial applications (ethernet, TV)

<b>I</b>	1 > 100 MbE	2 > 1 GbE	3 Up to 10 GbE	4 > 10 GbE	5 > 10 GbE TV
----------	----------------	--------------	-------------------	---------------	------------------

## Construction (conductor dimension, tensile strength)

<b>C</b>	1 AWG 27	2 AWG 26/25	3 AWG 24	4 AWG 23	5 AWG 22
----------	-------------	----------------	-------------	-------------	-------------

## EMC (coupling attenuation)

<b>E</b>	1 > 40 dB	2 > 50 dB	3 > 60 dB	4 > 70 dB	5 > 80 dB
----------	--------------	--------------	--------------	--------------	--------------

## Electrical characteristics (HF) at 20°C

Frequency MHz	Attenuation dB/10m		NEXT dB		PS-NEXT dB		ACR dB at 10m		PS-ACR dB at 10m		EL-FEXT dB at 10m		PS-ELFEXT dB at 10m		RL dB	
	Typ.	Cat. 7 max.*	Typ.	Cat. 7 min.*	Typ.	Cat. 7 min.*	Typ.	Cat. 7 min.*	Typ.	Cat. 7 min.*	Typ.	Cat. 7 min.*	Typ.	Cat. 7 min.*	Typ.	Cat. 7 min.*
1	0.25	0.29	100	80	97	77	100	80	97	77	100	80	97	80	24	23
10	0.76	0.85	99	80	96	77	99	79	96	77	95	74	92	71	33.9	25
100	2.49	2.78	95	72	92	69	93	70	90	69	69	54	66	51	38.3	20.1
200	3.69	4.01	92	68	89	65	88	64	85	65	65	48	62	45	35.3	18
250	4.18	4.53	90	66	87	63	86	62	83	63	62	46	59	43	32.9	17.3
500	5.6	6.62	83	62	80	59	78	55	75	59	54	40	51	37	29.7	17.3
600	6.74	7.33	81	61	78	58	74	53	71	58	50	38	47	35	30.6	17.3
700	7.32	-	80	-	77	-	72	-	69	-	50	-	47	-	31	-
800	7.89	-	77	-	74	-	69	-	66	-	50	-	47	-	26.7	-
900	8.5	-	75	-	72	-	67	-	64	-	34	-	31	-	28.6	-
1000	9.11	-	74	-	71	-	65	-	62	-	32	-	29	-	27.5	-
1100	9.5	-	72	-	69	-	63	-	60	-	28	-	25	-	26.9	-
1200	9.9	-	70	-	67	-	61	-	58	-	24	-	21	-	26.3	-

\* EN 50288-4-2(2014)/IEC 61156-6 (2010)

## Electrical characteristics at 20°C

Direct current resistance	Max.	145 Ω/km
Insulation resistance	Min.	5 GΩ x km
Mutual capacitance	Approx.	44 pF/m
Velocity of propagation (c)	Approx.	0.78
Propagation delay	Approx.	440 ns/100 m
Skew at 100 MHz	Approx.	2.5 ns/100 m
Charact. impedance	at 100 MHz	100 ± 5 Ω
Testing voltage U <sub>eff</sub>		1000 V
Operating voltage	Max.	125 V

## Thermal properties

For fixed installation	-40 °C up to +70 °C
For mobile operation	-10°C up to +50°C

## Chemical characteristics

Free of hazardous substances according to RoHS 2011/65/EU  
Oil resistance according to EN 60811-2-1  
Microbe resistance according to DIN VDE 0282  
Chemical resistance according to ISO 2812-1 and ISO 4628-1  
Hydrolysis resistance according to DIN 53504  
Free of lacquer-wetting substances (e.g. silicon oil)

## Cable printing

KERPEN DATACOM Made in Germany **MegaLine®** F10-120 S/F  
Flex 4P 11Y "Batch number" "Metre marking"

## Certificates and approvals

Link performance: KERPEN DATACOM **MegaLine®** systems  
and other commercially available connector systems  
Test certificates: according to DIN 55350-18-4.2.1 or EN 10204  
Compliant with LVD (2014/35/EU): **CE**

Dimensions	Outer Ø approx.	Weight approx.	Copper sales factor*	Sheath colour	Order no.
	mm	kg/km	kg/km		
4P	6.4	45	23.5	◆ Colza yellow	LKD7KS70090xxxx

Packaging: xxxx

Standard length: 0100 = 1000 m 0000 = general

\* See page 17: Definition of copper sales factor

# MegaLine® F6-90 S/F 11Y Flex

## Category 7



Type KS-02YSC11Y 4x2xAWG 27/7 PIMF

### Benefits

- ▶ Better than category 7
- ▶ Bandwidth 900 MHz
- ▶ Excellent shielding characteristics
- ▶ for installation in outdoor areas and in harsh environments
- ▶ RoHS and REACH conformity

### Construction for 4P

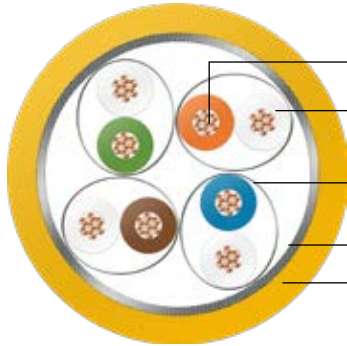

<b>Conductor</b>	Bare copper wire, AWG 27/7
<b>Insulation</b>	Foam PE, core Ø: Nominal value 1.0 mm
<b>Twisting element</b>	Pair
<b>Individual shielding</b>	Aluminium-bonded polyester foil, metal on the outside (PIMF)
<b>Twisting</b>	4 pairs
<b>Overall shielding</b>	Tinned copper wire braid
<b>Outer sheath</b>	PUR

### Fire behaviour

Flame retardancy	according to IEC 60332-2-2
Halogen free	according to IEC 60754-1/2
Smoke density	according to IEC 61034-1/2
Fire load (reference value)	0.46 MJ/m

### Performance

Better than category 7 according to 50288 and IEC 61156, excellent NEXT, excellent shielding properties (pairs and overall shielding), low skew  
Bandwidth (typical): 900 MHz

### Applications

Connection cables and patch cords for use in structured building cabling according to ISO/IEC 11801 and EN 50173 (3rd edition) and in accordance with ISO/IEC 24702 and EN 50173-3. Ideal for all applications of Classes D to F, multimedia (video, data, voice) > 10 GbE according to IEEE 802.3an, cable sharing, VoIP, PoE/PoE+. For use in harsh environments due to very rugged PUR sheath.

### Mechanical characteristics

Bending radius in operation	5 x outer diameter (min.)
Tensile strength (max.)	60 N

### Electromagnetic behaviour

Coupling resistance at 10 MHz (nom.)	5 mΩ/m
Screen attenuation (nom.)	60 dB
Coupling attenuation (nom.)	80 dB
Separating class according to EN 50174-2	d

### Security (fire behaviour)

<b>S</b>	1 IEC 60332-2-2	2 IEC-60332-1-2	3 IEC-60332-3-24	4 EFP Grade 1	5 EFP Grade 2
----------	--------------------	--------------------	---------------------	---------------------	---------------------

### Performance (cabling class, bandwidth)

<b>P</b>	1 > Class E > 250 MHz	2 > Class E <sub>1</sub> > 500 MHz	3 > Class F > 600 MHz	4 > Class F <sub>1</sub> > 1000 MHz	5 > Class G > 1200 MHz
----------	-----------------------------	--	-----------------------------	---	------------------------------

### Industrial applications (ethernet, TV)

<b>I</b>	1 > 100 MbE	2 > 1 GbE	3 Up to 10 GbE	4 > 10 GbE	5 > 10 GbE TV
----------	----------------	--------------	-------------------	---------------	---------------------

### Construction (conductor dimension, tensile strength)

<b>C</b>	1 AWG 27	2 AWG 26/25	3 AWG 24	4 AWG 23	5 AWG 22
----------	-------------	----------------	-------------	-------------	-------------

### EMC (coupling attenuation)

<b>E</b>	1 > 40 dB	2 > 50 dB	3 > 60 dB	4 > 70 dB	5 > 80 dB
----------	--------------	--------------	--------------	--------------	--------------

## Electrical characteristics (HF) at 20°C

Frequency MHz	Attenuation dB/10m		NEXT dB		PS-NEXT dB		ACR dB at 10m		PS-ACR dB at 10m		EL-FEXT dB at 10m		PS-ELFEXT dB at 10m		RL dB	
	Typ.	Cat. 7 max.*	Typ.	Cat. 7 min.*	Typ.	Cat. 7 min.*	Typ.	Cat. 7 min.*	Typ.	Cat. 7 min.*	Typ.	Cat. 7 min.*	Typ.	Cat. 7 min.*	Typ.	Cat. 7 min.*
1	0.26	0.29	95	80	92	77	95	80	92	77	92	80	89	80	21.8	-
10	0.83	0.85	94	80	91	77	94	79	91	77	84	74	81	71	29.7	25
100	2.74	2.78	90	72	87	69	88	70	85	69	70	54	67	51	35	20.1
200	3.9	4.01	87	68	84	65	83	64	80	65	60	48	57	45	33	18
250	4.39	4.53	85	66	82	63	81	62	78	63	56	46	53	43	31.6	17.3
500	6.21	6.62	78	62	75	59	72	55	69	59	52	40	49	37	28.8	17.3
600	6.91	7.33	76	61	73	58	69	53	66	58	48	38	45	35	27.1	17.3
700	7.48	-	75	-	72	-	67	-	64	-	34	-	31	-	26.4	-
800	8.06	-	72	-	69	-	64	-	61	-	34	-	31	-	24.7	-
900	8.62	-	70	-	67	-	62	-	59	-	11	-	8	-	24.4	-

\* EN 50288-4-2 (2014)/IEC 61156-6 (2010)

## Electrical characteristics at 20°C

Direct current resistance	Max.	170 Ω/km
Insulation resistance	Min.	5 GΩ x km
Mutual capacitance	Approx.	44 pF/m
Velocity of propagation (c)	Approx.	0.78
Propagation delay	Approx.	430 ns/100 m
Skew at 100 MHz	Approx.	2.5 ns/100 m
Charact. impedance	at 100 MHz	100 ± 5 Ω
Testing voltage U <sub>eff</sub>		1000 V
Operating voltage	Max.	125 V

## Thermal properties

For fixed installation	-40 °C up to +80 °C (20,000 operating hours)
For mobile operation	0°C up to +50°C

## Chemical characteristics

Free of hazardous substances according to RoHS 2011/65/EU  
 Oil resistance according to ICEA S-73-532 (60°C)  
 Microbe resistance according to DIN VDE 0282

## Cable printing

KERPEN DATACOM Made in Germany **MegaLine®** F6-90 S/F Flex  
 4P 11Y "Batch number" "Metre marking"

## Certificates and approvals

Link performance: KERPEN DATACOM **MegaLine®** systems  
 and other commercially available connector systems  
 Test certificates: according to DIN 55350-18-4.2.1 or EN 10204  
 Compliant with LVD (2014/35/EU): **CE**  
 Compliant with Construction Products Regulation  
 (EU/305/2011) **CE**

Dimensions	Outer Ø approx.	Weight approx.	Copper sales factor*	Sheath colour	Order no.
	mm	kg/km	kg/km		
4P	5.9	34	20	◆ Colza yellow	LKD7KS702430000

Packaging: xxxx

Standard length: 0100 = 1000 m 0000 = general

\* See page 17: Definition of copper sales factor

# MegaLine® D1-20 S/U 11Y Superflex

## Category 5



Type KS-6Y3GC11Y 4x2xAWG 26/19

### Benefits

- ▶ Better than category 5
- ▶ Bandwidth 100 MHz
- ▶ good shielding characteristics
- ▶ suitable for use with drag chains
- ▶ RoHS and REACH conformity
- ▶ Suitable for outdoor installation

### Construction for 4P

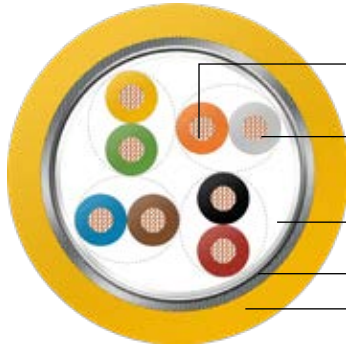

<b>Conductor</b>	Bare copper wire, AWG 26/19
<b>Insulation</b>	FEP, core Ø: Nominal value 1.0 mm
<b>Twisting element</b>	Pair
<b>Twisting</b>	4 pairs
<b>Taping</b>	Fleece foiling
<b>Inner sheath</b>	EPDM
<b>Taping</b>	Fleece foiling
<b>Overall shielding</b>	Tinned copper wire braiding, optical coverage approx. 90 %
<b>Outer sheath</b>	PUR

### Fire behaviour

Flame retardancy	according to IEC 60332-2-2
Fire load (reference value)	0.7 MJ/m

### Performance

Better than Category 5 according to EN 50288 and IEC 61156  
Excellent shielding properties, bandwidth (typical): 100 MHz

### Applications

Connection cables and patch cords for use in structured building cabling according to ISO/IEC 11801 and EN 50173 (3rd. edition). Ideal for all Class D applications up to 1 GbE according to IEEE 802.3ab, VoIP, PoE, PoE+/4PPoE. Suitable for use in harsh environments due to EPDM inner sheath and particularly robust PUR outer sheath. Suitability for drag chain use (typically 5 million cycles). Torsional suitability according to EN 50289-3-10. Suitable for use in clean rooms of air purity Class 2 in accordance with ISO 14644-1

### Mechanical characteristics

Bending radius	in operation	5 x outer diameter (min.)
Tensile strength (max.)		60 N
Crush strength		2000 N/100 mm
Impact strength (number of shocks)		20

### Electromagnetic behaviour

Coupling resistance at 10 MHz (nom.)	100 mΩ/m
Screen attenuation (nom.)	55 dB
Coupling attenuation (nom.)	75 dB
Separating class according to EN 50174-2	c

### Security (fire behaviour)

S	1 IEC 60332-2-2	2 IEC-60332-1-2	3 IEC-60332-3-24	4 EFP Grade 1	5 EFP Grade 2
---	--------------------	--------------------	---------------------	------------------	------------------

### Performance (cabling class, bandwidth)

P	1 > Class E > 250 MHz	2 > Class E <sub>A</sub> > 500 MHz	3 > Class F > 600 MHz	4 > Class F <sub>A</sub> > 1000 MHz	5 > Class F <sub>A</sub> + > 1200 MHz
---	-----------------------------	--	-----------------------------	---	---

### Industrial applications (ethernet, TV)

I	1 > 100 MbE	2 > 1 GbE	3 Up to 10 GbE	4 > 10 GbE	5 > 10 GbE TV
---	----------------	--------------	-------------------	---------------	------------------

### Construction (conductor dimension, tensile strength)

C	1 AWG 27	2 AWG 26/25	3 AWG 24	4 AWG 23	5 AWG 22
---	-------------	----------------	-------------	-------------	-------------

### EMC (coupling attenuation)

E	1 > 40 dB	2 > 50 dB	3 > 60 dB	4 > 70 dB	5 > 80 dB
---	--------------	--------------	--------------	--------------	--------------



### Electrical characteristics (HF) at 20°C

Frequency MHz	Attenuation dB/10m		NEXT dB		PS-NEXT dB		ACR dB at 10m		PS-ACR dB at 10m		EL-FEXT dB at 10m		PS-ELFEXT dB at 10m		RL dB	
	Typ.	Cat. 5 max.*	Typ.	Cat. 5 min.*	Typ.	Cat. 5 min.*	Typ.	Cat. 5 min.*	Typ.	Cat. 5 min.*	Typ.	Cat. 5 min.*	Typ.	Cat. 5 min.*	Typ.	Cat. 5 min.*
1	0.22	0.32	80	65	77	62	80	65	77	62	80	64	77	61	27	-
4	0.58	0.60	67	56	64	53	67	56	64	53	69	52	66	49	26	23
10	1.1	1.05	63	50	60	47	62	49	59	47	61	44	65	58	30	25
16	1.4	1.45	61	47	58	44	60	46	57	44	56	40	53	37	30	25
20	1.6	1.6	59	46	56	43	58	44	55	43	53	38	50	35	30	25
31.25	2.1	2	57	43	54	40	55	41	52	40	48	34	45	31	30	23.6
62.5	3.2	3	52	38	49	35	50	36	47	35	43	28	40	25	28	21.5
100	4.2	4	45	35	42	32	42	32	39	32	38	24	35	21	26	20.1

\* Based on EN 50288-2-2 (2004)/IEC 61156-6 (2010)

### Electrical characteristics at 20°C

Direct current resistance	Max.	130 Ω/km
Insulation resistance	Min.	5 GΩ x km
Mutual capacitance	Approx.	50 pF/m
Velocity of propagation (c)	Approx.	0.68
Propagation delay	Approx.	490 ns/100 m
Skew at 100 MHz	Approx.	15 ns/100 m
Charact. impedance	at 100 MHz	100 ± 5 Ω
Testing voltage U <sub>eff</sub>		1000 V
Operating voltage	Max.	125 V

### Thermal properties

For fixed installation	-40 °C up to +85 °C
For mobile operation	0°C up to +50°C

### Cable printing

KERPEN DATACOM Made in Germany **MegaLine®** D1-20 S/U  
Superflex 4P 11Y "Batch number" "Metre marking"

### Chemical characteristics

Free of hazardous substances according to RoHS 2011/65/EU  
Oil resistance according to EN 60811-2-1  
Ozone resistance according to EN 60811  
Cleanability according to riboflavin test (VDMA)  
Microbe resistance according to DIN VDE 0282  
Chemical resistance according to ISO 2812-1 and ISO 4628-1  
Hydrolysis resistance according to DIN 53504  
Free of lacquer-wetting substances (e.g. silicon oil)  
Emissions response of TVOC according to ISO 14644-8: ISO-AMCm-8.1

### Certificates and approvals

Quality mark with production control:  
Fraunhofer IPA Tested Device Report no. LE 1212-626  
Link performance: KERPEN DATACOM **MegaLine®** systems  
and other commercially available connector systems  
Test certificates: according to DIN 55350-18-4.2.1 or EN 10204  
Compliant with LVD (2014/35/EU): **CE**

Dimensions	Outer Ø approx.	Weight approx.	Copper sales factor*	Sheath colour	Order no.
	mm	kg/km	kg/km		
4P	6.8	58	28.6	◆ Colza yellow	LKD7KS50051xxxx

Packaging: xxxx

Standard length: 0100 = 1000 m 0000 = general

\* See page 17: Definition of copper sales factor

# MegaLine® SPE AWG 26/7 Universal

Based on category 7



Type KS-v02YSCH 1x2xAWG 26/7 PIMF

## Benefits

- ▶ Based on category 7
- ▶ Bandwidth 600 MHz
- ▶ Excellent shielding characteristics
- ▶ suitable for use with drag chains
- ▶ RoHS and REACH conformity

## Construction

for 1P

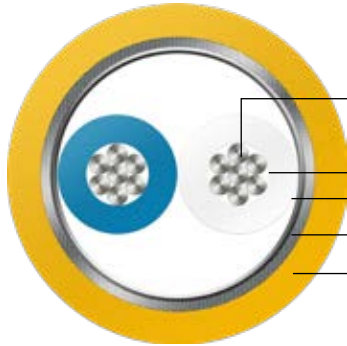

<b>Conductor</b>	Tinned copper wire, AWG 26/7
<b>Insulation</b>	Foam EP, core Ø: Nominal value 1.2 mm
<b>Twisting element</b>	Pair
<b>Individual shielding</b>	Aluminium-bonded polyester foil, metal on the outside (PiMF)
<b>Overall shielding</b>	Tinned copper wire braiding, optical coverage approx. 85%
<b>Outer sheath</b>	halogen-free, flame-retardant compound

## Fire behaviour

Flame retardancy	according to IEC 60332-1-2
Halogen-free	according to 60754-1/2
Smoke density	according to IEC 61034-1/2
Fire load (reference value)	0.57 MJ/m

## Performance

According to IEC 61156-12 (draft), low attenuation, excellent shielding characteristics (pairs and overall shielding), Bandwidth (typical): 600 MHz

## Applications

Installation cable for use in structured building cabling according to ISO/IEC 11801 and EN 50173 (3rd edition) and ISO/IEC TR 11801-9906. Ideal for all SPE applications (1P) according to 1000BASE-T1 in line with IEEE 802.3bp. For outdoor use under certain conditions

## Mechanical characteristics

Bending radius in operation	8 x outer diameter (min.)
After installation	4 x outer diameter (min.)
Tensile strength (max.)	25 N

## Electromagnetic behaviour

Coupling resistance at 10 MHz (nom.)	5 mΩ/m
Screen attenuation (nom.)	60 dB
Coupling attenuation (nom.)	85 dB
Separating class according to EN 50174-2	d

## Security (fire behaviour)

<b>S</b>	1 IEC 60332-2-2	2 IEC-60332-1-2	3 IEC-60332-3-24	4 EFP Grade 1	5 EFP Grade 2
----------	--------------------	--------------------	---------------------	---------------------	---------------------

## Performance (cabling class, bandwidth)

<b>P</b>	1 > Class E > 250 MHz	2 > Class E <sub>x</sub> > 500 MHz	3 > Class F > 600 MHz	4 > Class F <sub>x</sub> > 1000 MHz	5 > Class G > 1200 MHz
----------	-----------------------------	--	-----------------------------	---	------------------------------

## Industrial applications (ethernet, TV)

<b>I</b>	1 > 100 MbE	2 > 1 GbE	3 Up to 10 GbE	4 > 10 GbE	5 > 10 GbE TV
----------	----------------	--------------	-------------------	---------------	---------------------

## Construction (conductor dimension, tensile strength)

<b>C</b>	1 AWG 27	2 AWG 26/25	3 AWG 24	4 AWG 23	5 AWG 22
----------	-------------	----------------	-------------	-------------	-------------

## EMC (coupling attenuation)

<b>E</b>	1 > 40 dB	2 > 50 dB	3 > 60 dB	4 > 70 dB	5 > 80 dB
----------	--------------	--------------	--------------	--------------	--------------

### Electrical characteristics (HF) at 20°C

Frequency MHz	Attenuation dB/10m		NEXT dB		PS-NEXT dB		ACR dB at 10m		PS-ACR dB at 10m		EL-FEXT dB at 10m		PS-ELFEXT dB at 10m		RL dB	
	Typ.	Cat. 5 max.*	Typ.	Cat. 5 min.*	Typ.	Cat. 5 min.*	Typ.	Cat. 5 min.*	Typ.	Cat. 5 min.*	Typ.	Cat. 5 min.*	Typ.	Cat. 5 min.*	Typ.	Cat. 5 min.*
1	2.31	2.9	-	-	-	-	-	-	-	-	-	-	-	-	23.3	23
10	6.67	8.5	-	-	-	-	-	-	-	-	-	-	-	-	26.1	25
100	22.2	27.8	-	-	-	-	-	-	-	-	-	-	-	-	31.7	20.1
200	32.6	39.7	-	-	-	-	-	-	-	-	-	-	-	-	32.1	18
250	37.2	44.6	-	-	-	-	-	-	-	-	-	-	-	-	29.6	17.3
500	53.9	64.1	-	-	-	-	-	-	-	-	-	-	-	-	26.5	17.3
600	60	70.6	-	-	-	-	-	-	-	-	-	-	-	-	38.7	17.3

\* Based on IEC 61156-12 (2018)

### Electrical characteristics at 20°C

Direct current resistance	Max.	126 Ω/km
Insulation resistance	Min.	5 GΩ x km
Mutual capacitance	Approx.	47 pF/m
Velocity of propagation (c)	Approx.	0.71
Propagation delay	Approx.	475 ns/100 m
Charact. impedance	at 100 MHz	100 ± 5 Ω
Testing voltage U <sub>eff</sub>		1000 V
Operating voltage	Max.	125 V

### Thermal properties

For fixed installation	-40 °C up to +80 °C
For mobile operation	0°C up to +50°C

### Cable printing

KERPEN DATACOM Made in Germany **MegaLine®** SINGLE PAIR  
 ETHERNET AWG26/7 FRNC 600MHz IEC 61156-11 Universal  
 "Batch number" "Metre marking"

### Chemical characteristics

Free of hazardous substances according to RoHS 2011/65/EU  
 Oil resistance according to ICEA S-73-532 (60°C)  
 Microbe resistance according to DIN VDE 0282

### Certificates and approvals

Link performance: KERPEN DATACOM **MegaLine®** systems  
 and other commercially available connector systems  
 Test certificates: according to DIN 55350-18-4.2.1 or EN 10204  
 Compliant with LVD (2014/35/EU): **CE**  
 Compliant with Construction Products Regulation  
 (EU/305/2011) **CE**

Dimensions	Outer Ø approx.	Weight approx.	Copper sales factor*	Sheath colour	Order no.
	mm	kg/km	kg/km		
1P	4.7	30	13.0	◆ Colza yellow	LKD7KS704160000

Packaging: xxxx

Standard length: 0100 = 1000 m 0000 = general

\* See page 17: Definition of copper sales factor

# MegaLine® SPE AWG 22/7 Universal

Based on category 7



Type KS-v02YSCH 1x2xAWG 22/7

## Advantages based on Cat. 7

- ▶ Better than category 7
- ▶ Bandwidth 600 MHz
- ▶ Excellent shielding characteristics
- ▶ suitable for use with drag chains
- ▶ RoHS and REACH conformity

## Construction for 1P

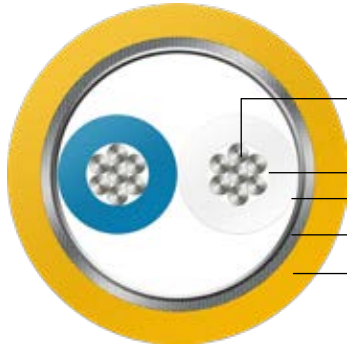

<b>Conductor</b>	Tinned copper wire, AWG 22/7
<b>Insulation</b>	Foam EP, core Ø: Nominal value 1.5 mm
<b>Twisting element</b>	Pair
<b>Individual shielding</b>	Aluminium-bonded polyester foil, metal on the outside (PiMF)
<b>Overall shielding</b>	Tinned copper wire braiding, optical coverage approx. 85%
<b>Outer sheath</b>	halogen-free, flame-retardant compound

## Fire behaviour

Flame retardancy	according to IEC 60332-1-2
Halogen free	according to IEC 60754-1/2
Smoke density	according to IEC 61034-1/2
Fire load (reference value)	0.58 MJ/m

## Performance

In line with IEC 61156-11 (draft), low attenuation, excellent shielding characteristics (pairs and overall shielding), Bandwidth (typical): 600 MHz

## Applications

Installation cable for use in structured building cabling according to ISO/IEC 11801 and EN 50173 (3rd edition) and ISO/IEC TR 11801-9906. Ideally suited for all SPE applications (1P) according to 1000BASE-T1 in line with IEEE 802.3bp. For outdoor use under certain conditions

## Mechanical characteristics

Bending radius in operation	8 x outer diameter (min.)
After installation	4 x outer diameter (min.)
Tensile strength (max.)	30 N

## Electromagnetic behaviour

Coupling resistance at 10 MHz (nom.)	5 mΩ/m
Screen attenuation (nom.)	60 dB
Coupling attenuation (nom.)	85 dB
Separating class according to EN 50174-2	d

## Security (fire behaviour)

<b>S</b>	1 IEC 60332-2-2	2 IEC-60332-1-2	3 IEC-60332-3-24	4 EFP Grade 1	5 EFP Grade 2
----------	--------------------	--------------------	---------------------	---------------------	---------------------

## Performance (cabling class, bandwidth)

<b>P</b>	1 > Class E > 250 MHz	2 > Class E <sub>x</sub> > 500 MHz	3 > Class F > 600 MHz	4 > Class F <sub>x</sub> > 1000 MHz	5 > Class G > 1200 MHz
----------	-----------------------------	--	-----------------------------	---	------------------------------

## Industrial applications (ethernet, TV)

<b>I</b>	1 > 100 MbE	2 > 1 GbE	3 Up to 10 GbE	4 > 10 GbE	5 > 10 GbE TV
----------	----------------	--------------	-------------------	---------------	---------------------

## Construction (conductor dimension, tensile strength)

<b>C</b>	1 AWG 27	2 AWG 26/25	3 AWG 24	4 AWG 23	5 AWG 22
----------	-------------	----------------	-------------	-------------	-------------

## EMC (coupling attenuation)

<b>E</b>	1 > 40 dB	2 > 50 dB	3 > 60 dB	4 > 70 dB	5 > 80 dB
----------	--------------	--------------	--------------	--------------	--------------

### Electrical characteristics (HF) at 20°C

Frequency MHz	Attenuation dB/10m		NEXT dB		PS-NEXT dB		ACR dB at 10m		PS-ACR dB at 10m		EL-FEXT dB at 10m		PS-ELFEXT dB at 10m		RL dB	
	Typ.	Cat. 5 max.*	Typ.	Cat. 5 min.*	Typ.	Cat. 5 min.*	Typ.	Cat. 5 min.*	Typ.	Cat. 5 min.*	Typ.	Cat. 5 min.*	Typ.	Cat. 5 min.*	Typ.	Cat. 5 min.*
1	1.7	2.1	-	-	-	-	-	-	-	-	-	-	-	-	24	20
10	4.4	5.8	-	-	-	-	-	-	-	-	-	-	-	-	33.9	25
100	15	18.5	-	-	-	-	-	-	-	-	-	-	-	-	38.3	20.1
200	21.7	26.5	-	-	-	-	-	-	-	-	-	-	-	-	35.3	18
250	24.5	29.7	-	-	-	-	-	-	-	-	-	-	-	-	32.9	17.3
500	35.7	42.8	-	-	-	-	-	-	-	-	-	-	-	-	29.7	17.3
600	40	47.1	-	-	-	-	-	-	-	-	-	-	-	-	30.6	17.3

\* Based on EN 50288-2-2 (2004)/IEC 61156-6 (2010)

### Electrical characteristics at 20°C

Direct current resistance	Max.	49.8 Ω/km
Insulation resistance	Min.	5 GΩ x km
Mutual capacitance	Approx.	47 pF/m
Velocity of propagation (c)	Approx.	0.71
Propagation delay	Approx.	475 ns/100 m
Charact. impedance	at 100 MHz	100 ± 5 Ω
Testing voltage U <sub>eff</sub>		1000 V
Operating voltage	Max.	125 V

### Thermal properties

For fixed installation	-40 °C up to +80 °C
For mobile operation	0°C up to +50°C

### Cable printing

KERPEN DATACOM Made in Germany **MegaLine**®SINGLE PAIR  
 ETHERNET AWG 22/7 FRNC 600 MHz IEC 61156-11 Universal  
 Made in Germany "Batch number" "Metre marking"

### Chemical characteristics

Free of hazardous substances according to RoHS 2011/65/EU  
 Oil resistance according to ICEA S-73-532 (60°C)  
 Microbe resistance according to DIN VDE 0282

### Certificates and approvals

Link performance: KERPEN DATACOM **MegaLine**® systems  
 and other commercially available connector systems  
 Test certificates: according to DIN 55350-18-4.2.1 or EN 10204  
 Compliant with LVD (2014/35/EU): **CE**  
 Compliant with Construction Products Regulation  
 (EU/305/2011) **CE**

Dimensions	Outer Ø approx.	Weight approx.	Copper sales factor*	Sheath colour	Order no.
	mm	kg/km	kg/km		
1P	5.3	36	17.5	◆ Colza yellow	LKD7KS704150000

Packaging: xxxx

Standard length: 0100 = 1000 m 0000 = general

\* See page 17: Definition of copper sales factor

# MegaLine® Slim 600

## Category 7



Type KS-02YSCH 4x2xAWG 26/1 PIMF

### Benefits

- ▶ Category 7 up to 65 m
- ▶ Particularly flexible, thin and light
- ▶ White sheath, perfect for home interiors

### Construction for 4P

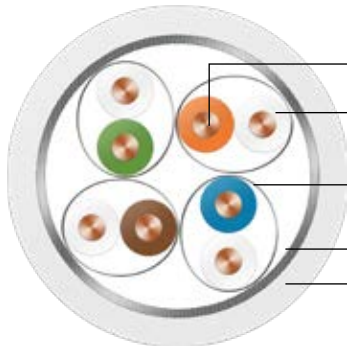

<b>Conductor</b>	Bare copper wire, AWG 26/1
<b>Insulation</b>	Foam PE, core Ø: Nominal value 1.0 mm
<b>Twisting element</b>	Pair
<b>Individual shielding</b>	Aluminium-bonded polyester foil, metal on the outside (PIMF)
<b>Twisting</b>	4 pairs
<b>Overall shielding</b>	Tinned copper wire braid
<b>Outer sheath</b>	halogen-free, flame-retardant compound

### Fire behaviour

Flame retardancy	according to IEC 60332-1-2
Halogen free	according to IEC 60754-1/2
Smoke density	according to IEC 61034-1/2
Fire load (reference value)	0.4 MJ/m
EU Construction Products Regulation	according to EN 50575 / EN 50399

### Performance

Better than Category 7 according to EN 50288 and IEC 61156 excellent NEXT, excellent shielding characteristics (pairs and overall shielding), low skew. Very easy to install and space-saving thanks to its small diameter, tight bending radius and low weight. Bandwidth (typical): 700 MHz

### Applications

Installation cable for household cabling. Ideal for all applications of Classes D to F, multimedia (video, data voice) > 10 GbE according to IEEE 802.3an, cable sharing, VoIP, PoE/PoE+/4PPoE. For transmission links of max. 65 m.

### Mechanical characteristics

Bending radius	During installation	8 x outer diameter (min.)
	After installation	4 x outer diameter (min.)
Tensile strength (max.)		50 N
Crush strength		1000 N/100 mm
Impact strength (number of shocks)		10

### Electromagnetic behaviour

Coupling resistance at 10 MHz (nom.)	5 mΩ/m
Screen attenuation (nom.)	70 dB
Coupling attenuation (nom.)	85 dB
Separating class according to EN 50174-2	d

### Security (fire behaviour)

<b>S</b>	<b>1</b> IEC 60332-2-2	<b>2</b> IEC-60332-1-2	<b>3</b> IEC-60332-3-24	<b>4</b> EFP Grade 1	<b>5</b> EFP Grade 2
		<b>E<sub>ca</sub>/D<sub>ca</sub></b>	<b>E<sub>ca</sub>/D<sub>ca</sub></b>	<b>C<sub>ca</sub></b>	<b>B2<sub>ca</sub></b>

### Performance (cabling class, bandwidth)

<b>P</b>	<b>1</b> > Class E > 250 MHz	<b>2</b> > Class E <sub>A</sub> > 500 MHz	<b>3</b> > Class F > 600 MHz	<b>4</b> > Class F <sub>A</sub> > 1000 MHz	<b>5</b> > Class F <sub>A+</sub> > 1200 MHz
----------	------------------------------------	---	------------------------------------	--	---

### Application (Ethernet, TV)

<b>A</b>	<b>1</b> > 100 MbE	<b>2</b> > 1 GbE	<b>3</b> Up to 10 GbE	<b>4</b> > 10 GbE	<b>5</b> > 10 GbE TV
----------	-----------------------	---------------------	--------------------------	----------------------	-------------------------

### Construction (conductor dimension, tensile strength)

<b>C</b>	<b>1</b> AWG 27	<b>2</b> AWG 26/25	<b>3</b> AWG 24	<b>4</b> AWG 23	<b>5</b> AWG 22
----------	--------------------	-----------------------	--------------------	--------------------	--------------------

### EMC (coupling attenuation)

<b>E</b>	<b>1</b> > 40 dB	<b>2</b> > 50 dB	<b>3</b> > 60 dB	<b>4</b> > 70 dB	<b>5</b> > 80 dB
----------	---------------------	---------------------	---------------------	---------------------	---------------------

### Electrical characteristics (HF) at 20°C

Frequency MHz	Attenuation dB/10m		NEXT dB		PS-NEXT dB		ACR dB at 10m		PS-ACR dB at 10m		EL-FEXT dB at 10m		PS-ELFEXT dB at 10m		RL dB	
	Typ.	Cat. 7 max.*	Typ.	Cat. 7 min.*	Typ.	Cat. 7 min.*	Typ.	Cat. 7 min.*	Typ.	Cat. 7 min.*	Typ.	Cat. 7 min.*	Typ.	Cat. 7 min.*	Typ.	Cat. 7 min.*
1	0.25	0.29	100	80	97	77	100	80	97	77	100	80	97	80	24	23
10	0.76	0.85	99	80	96	77	99	79	96	77	95	74	92	71	33.9	25
100	2.49	2.78	95	72	92	69	93	70	90	69	69	54	66	51	38.3	20.1
200	3.69	4.01	92	68	89	65	88	64	85	65	65	48	62	45	35.3	18
250	4.18	4.53	90	66	87	63	86	62	83	63	62	46	59	43	32.9	17.3
500	5.6	6.62	83	62	80	59	78	55	75	59	54	40	51	37	29.7	17.3
600	6.74	7.33	81	61	78	58	74	53	71	58	50	38	47	35	30.6	17.3
700	7.32	-	80	-	77	-	72	-	69	-	50	-	47	-	31	-

\* EN 50288-4-2 (2014)/IEC 61156-6 (2010)

### Electrical characteristics at 20°C

Direct current resistance	Max.	145 Ω/km
Insulation resistance	Min.	5 GΩ x km
Mutual capacitance	Approx.	44 pF/m
Capacitive coupling (e)	Approx.	1100 pF/km
Velocity of propagation (c)	Approx.	0.71
Propagation delay	Approx.	440 ns/100 m
Skew at 100 MHz	Approx.	5 ns/100 m
Charact. impedance	at 100 MHz	100 ± 5 Ω
Testing voltage U <sub>eff</sub>		1000 V
Operating voltage	Max.	125 V

### Thermal properties

For fixed installation	-20 °C up to +60 °C
For mobile operation	0°C up to +50°C

### Chemical characteristics

Free of hazardous substances according to RoHS 2011/65/EU

### Cable printing

KERPEN DATACOM Made in Germany **MegaLine®** Slim 600 4PPoE  
"CPR Class" "DoP no." "Batch number" "Metre marking"

### Certificates and approvals

Link performance: Excellent for processing with **MegaLine®** Connect45 Pro and **MegaLine®** Patch connection components.  
Compliant with LVD (2014/35/EU): **CE**  
Compliant with Construction Products Regulation (EU/305/2011): **CE**

Dimensions	Outer Ø approx.	Weight approx.	Copper sales factor*	CPR Class	DoP no.	Sheath colour	Order no.
	mm	kg/km	kg/km				
4P	5.7	39	20	D <sub>ca</sub> s2 d2 a1	CDESK0000031	◇ Signal white	LKD7KS70304xxxx

Packaging: xxxx

Standard length: 0100 = 1000 m 0035 = 305 m 0010 = 100 m 0000 = general

\* See page 17: Definition of copper sales factor

# MegaLine® Connect100 COPPER CONNECTION TECHNOLOGY











UPGRADE YOUR PERFORMANCE TO CAT. 6<sub>A</sub>, 7, 7<sub>A</sub>, 8.2 ETC.





# MegaLine® Connect100

The cabling system from 10 – 40 Gbit/s

MegaLine® Connect100 copper connection technology		Page
	Ready for 40 Gbit/s Perfection in efficiency, future-orientation & electrical performance	106
	40 GBASE-T over copper	108
	The cabling system from 10 – 40 Gbit/s – system overview	110
	Cable plugs	<ul style="list-style-type: none"> <li>• Cable plug Cat. 7<sub>A</sub></li> <li>• Cable plug Flex Cat. 7<sub>A</sub></li> </ul> 112
	Jack modules	<ul style="list-style-type: none"> <li>• Jack module 4K7A Cat. 7<sub>A</sub></li> <li>• Jack module RJ45 Cat. 6<sub>A</sub></li> </ul> 113
	Interface	<ul style="list-style-type: none"> <li>• Interface</li> <li>• Interface connector solid / flex</li> </ul> 114
	Wall outlets for MegaLine® Connect100 jack modules	<ul style="list-style-type: none"> <li>• 50 x 50</li> <li>• 45 x 45</li> </ul> 115
	Patch panel 19" MegaLine® Connect100	unequipped 116
	DIN rail housing	2-fold with DIN rail clip 116
	MegaLine® accessories and cable assembly tools	<ul style="list-style-type: none"> <li>• Assembly aid</li> <li>• Crimping tool</li> <li>• Earthing cable</li> </ul> 117
	Office	
	Data centres	
	Industry	

# MegaLine® – READY FOR 40 GBIT/S

Perfect combination of efficiency, future-orientation & electrical performance

The **MegaLine®** system consists of the data cables G20 S/F and G20 S/F Flex and the 40 GBit/s-compatible **MegaLine® Connect100** cable plug. The connection is created as required by simply plugging in the desired jack module (RJ45, ARJ45®, TERA®, interface).



MegaLine® data cable Cat. 7<sub>A</sub>

Assembled  
cable plug Cat. 7<sub>A</sub>

Just connect the desired jack  
module, and you're done

**MegaLine® G20 S/F** according to IEC 61156-9

**Cat.8.2**

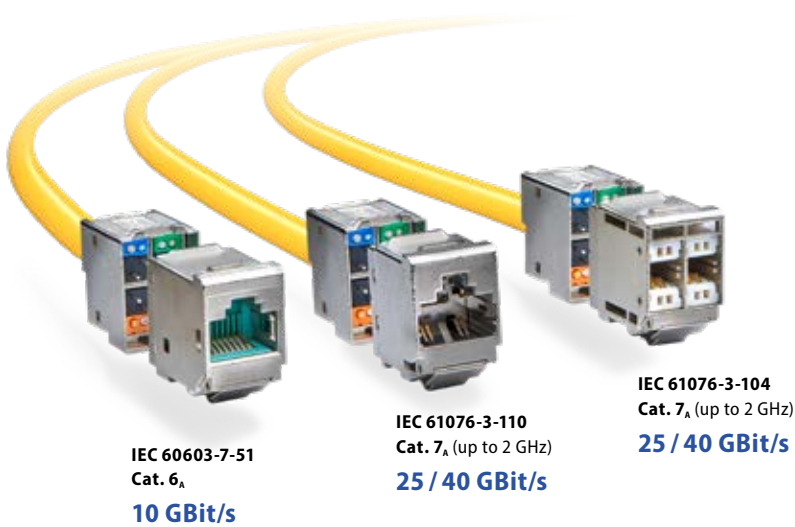

IEC 60603-7-51  
Cat. 6<sub>A</sub>  
**10 GBit/s**

IEC 61076-3-110  
Cat. 7<sub>A</sub> (up to 2 GHz)  
**25 / 40 GBit/s**

IEC 61076-3-104  
Cat. 7<sub>A</sub> (up to 2 GHz)  
**25 / 40 GBit/s**

## Efficiency ▶▶

- ▶ Unique cable connection with multiple uses
- ▶ Replaceable jack modules
- ▶ Varying performance
- ▶ Low maintenance and service costs
- ▶ Short assembly and upgrade time
- ▶ Pre-assembled links (low downtime)

**Performance ▶▶** Ready for 25 / 40 GBASE-T

## Easy to install ▶▶

- ▶ Unique cable connection with multiple uses
- ▶ Modular construction
- ▶ Pre-assembled links

## Outstanding quality ▶▶

Independently monitored by the  
GHMT Premium Verification Program



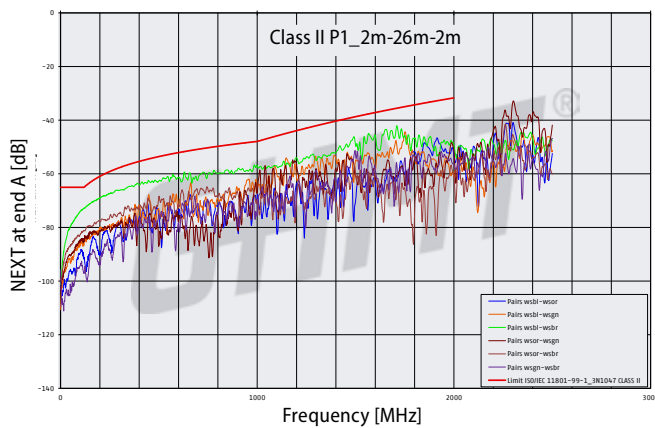
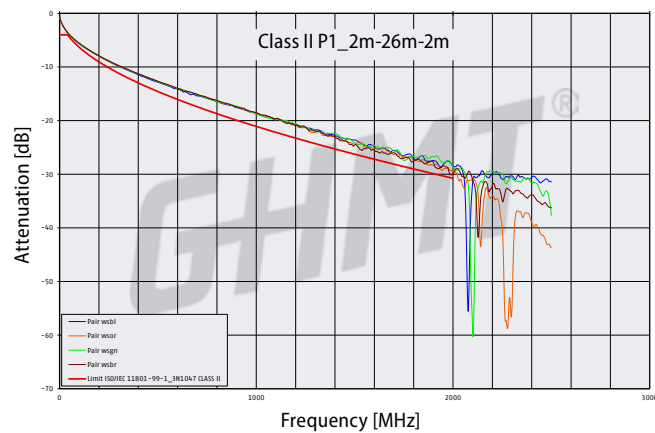
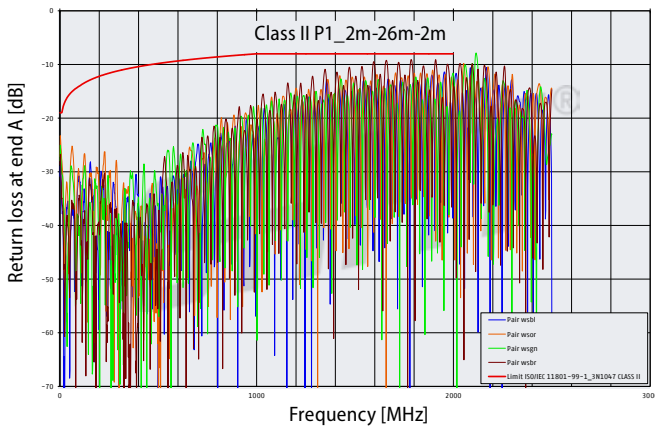

The combination of high-quality individual components is reflected by the channel measurement results (Class II). According to the current edition of ISO/IEC 11801 3rd edition, good reserves are achieved.

**Technological advance: 40 GBASE-T**

The next 40 GBASE-T technological leap, driven by the demand for increasingly higher performance on the active component side, requires the technological improvement of passive system technology.

■ **FO** Core networking doubles = 18 months

■ **Copper** Server I/O doubles = 24 months

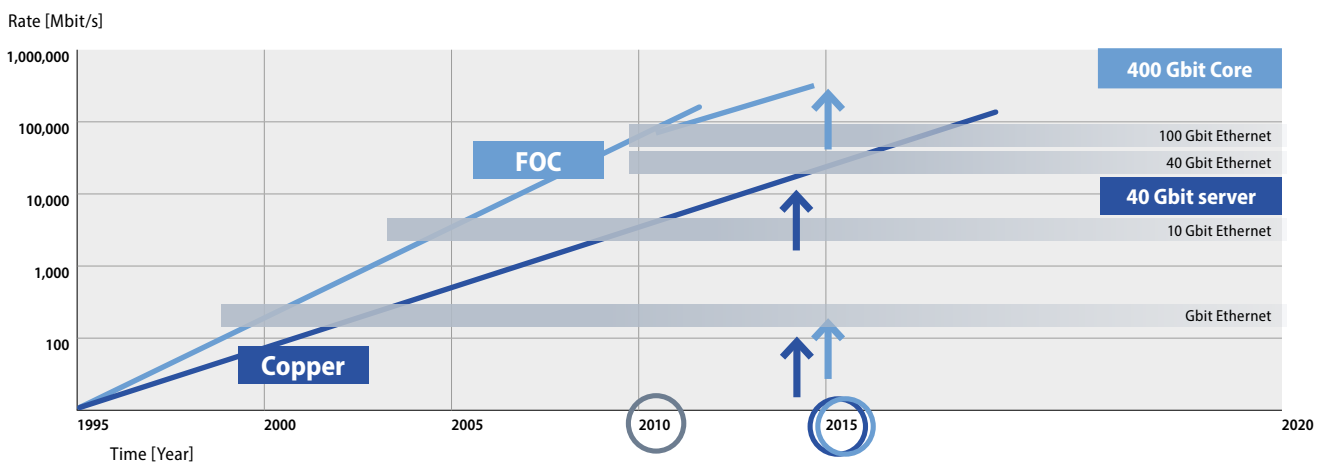

# MegaLine® – 40 GBASE-T OVER COPPER

Areas of application for 40 GBASE-T system technology: End-of-Row / Top-of-Rack topology:

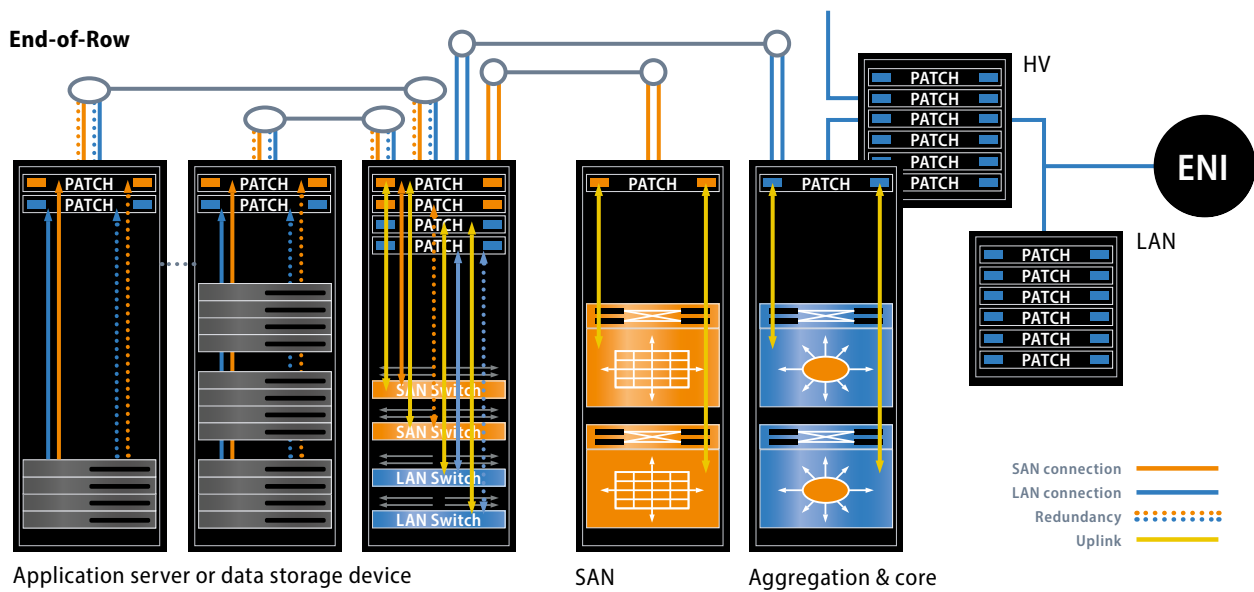

The requirements for the following transmission links in the data centre are specified under the designation IEEE 802.3bq:

- ▶ EoR/MoR: Server/switch links of up to 30 m with 2 connectors
- ▶ ToR: Port-to-port links using 5–10 m of patch cord

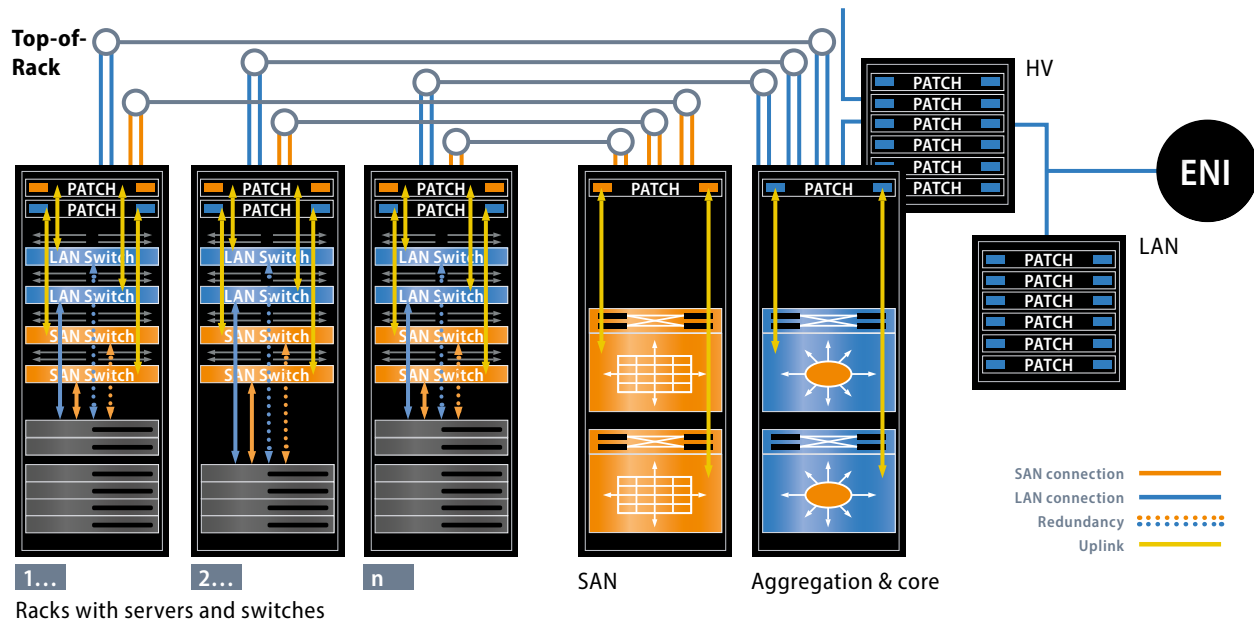

The deficiencies of previous solutions in line with IEEE 802.3ba for 40 Gbit/s applications essentially led to the introduction of the new Ethernet standard:

- ▶ Ranges limited to 7 m with 8-pair CR4 Twinax cable (Top-of-Rack cabling)
- ▶ Inadequate operating efficiency and migration options for 8-fibre OM3 / OM4 fibre optic cables (End-of-Row cabling)
- ▶ Inadequate efficiency of 2-fibre SM fibre optic cables (1310 CWDM / 1550 nm) up to 10 km / 2 km

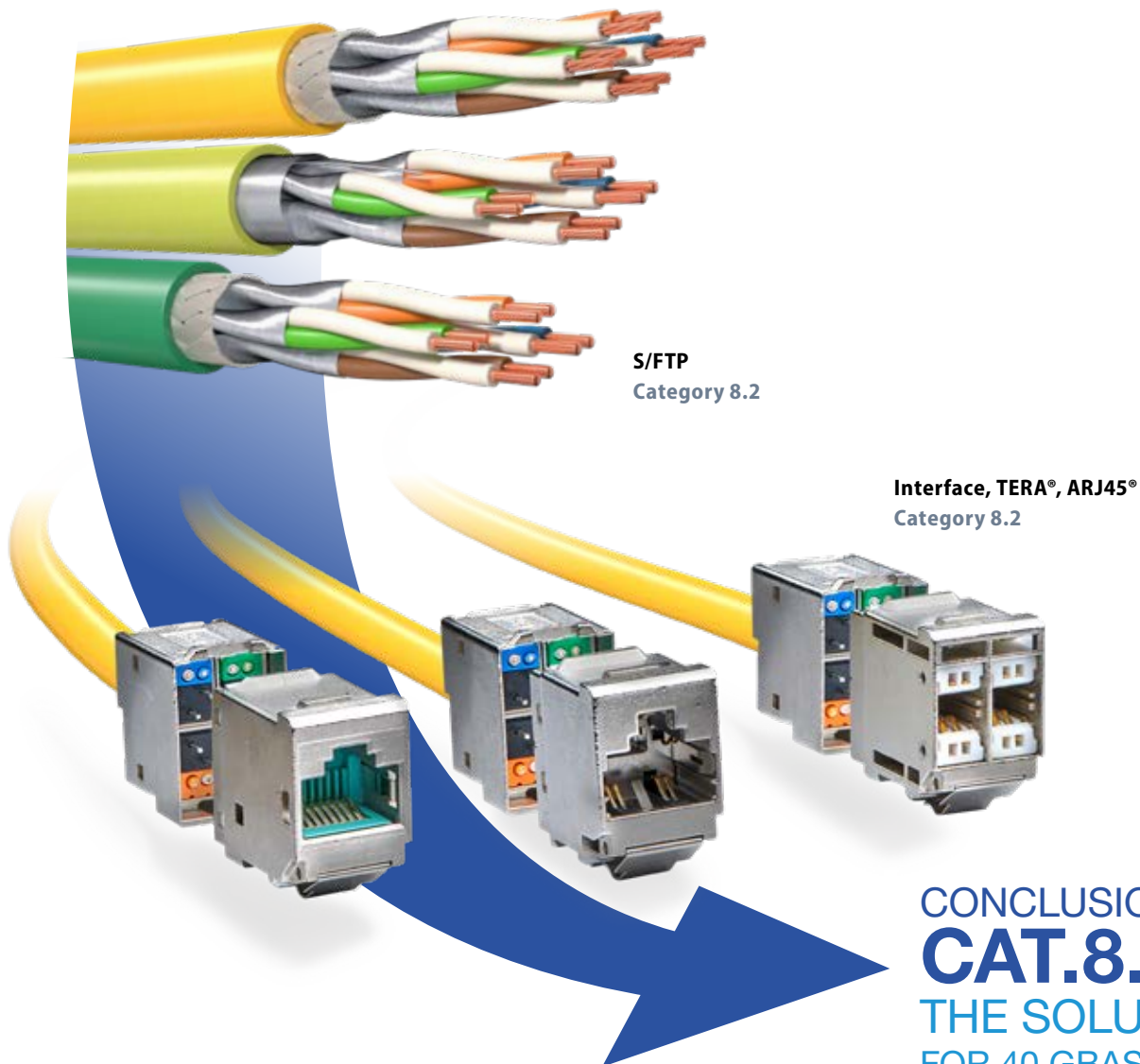

CONCLUSION:  
**CAT.8.2**  
 THE SOLUTION:  
 FOR 40 GBASE-T

The Technical Report ISO/IEC 11801-99-1 (draft) recommends the following for implementing 40 Gbit/s over 4-pair cabling:

- ▶ Class I (based on Cat. 8.1 components)
- ▶ Class II (based on Cat. 8.2 components)

#### The technical superiority of Class II

(with Category 8.2 components) results from much higher reserves of NEXT, PSNEXT, ACR-F and PSACR-F.

#### Additional advantages:

- ▶ Only Category 8.2 components are backwards-compatible with Cat. 7 and Cat. 7<sub>A</sub>
- ▶ Category 8.2 components provide reserves for further increases in data rates

Class II cabling is the more cost-effective solution due to the lower design costs of the active technology (lower compensation expenditures). The cost of Cat. 8.1 or Cat. 8.2 cables is assumed to be equal.

# MegaLine® – THE CABLING SYSTEM FROM 10–40 GBIT/S

System overview

## MegaLine® Connect 100

MegaLine® Connect100  
cable plugs  
Page 112

8C7A jack module  
(up to 2 GHz)

4K7A jack module (up  
to 2 GHz)  
Page 113

For  
data rates  
up to

10  
Gbit/s

25  
Gbit/s

40  
Gbit/s

MegaLine® Flex cable

Flex cable plug  
(up to 2 GHz)

RJ45 jack module  
Cat. 6<sub>A</sub>  
Page 113



VarioLine® UF  
underfloor systems  
Page 151



copper  
Systems technology  
**MegaLine®**



**MegaLine® Connect100**  
Wall outlets  
Page 115



**VarioLine® CP**  
consolidation  
point housing  
Page 148



**MegaLine® Connect100**  
Patch panel 19" / 1 RU  
Page 116



**MegaLine®**  
ARJ patch cord  
TERA® patch cord  
Page 138

**10**  
Gbit/s

**25**  
Gbit/s

**40**  
Gbit/s



**MegaLine®**  
RJ45 patch cord  
Page 133

# MegaLine® Connect100 CABLE PLUG

Category 7<sub>A</sub>



## MegaLine® Connect100 cable plug Cat. 7A MegaLine® Connect100 Flex cable plug Cat. 7A

### Description

Interface to the modular interchangeable **MegaLine® Connect100** jack module. This cable plug can be used to create generic transmission links that far exceed the requirements for Class F<sub>A</sub>. Users can determine the correct mating face at a later time without making installation any more difficult.

- ▶ Various mating faces available
- ▶ Simple and fast assembly

### Structure

Material	PC; die-cast zinc, nickel-plated
Wiring	4 pairs using punch down technology
Strain relief	Via cable ties
Shielding	Large-surface, 360° shield contact
Electrical values	Class F <sub>A</sub> / Category 7 <sub>A</sub> / up to 2 GHz

### Electrical properties

Contact resistance	≤ 20 Ω	
Isolation resistance	≥ 500 MΩ	between contacts
Proof voltage	≥ 1000 V DC/AC	contact – contact
	≥ 1500 V DC/AC	contact – shielding
Current rating	1.25 A at 50° C	

### Standards

- ▶ ISO/IEC 11801
- ▶ EN 50173-1
- ▶ IEEE 802.3af/at (PoE/PoE+)

Article	Cat.	Order no.
<b>MegaLine® Connect100</b> Cable plugs (AWG 24-22 solid)	Cat. 7 <sub>A</sub> (up to 2 GHz)	LKD9A9023300000
<b>MegaLine® Connect100</b> Cable plug flex (AWG 27-26 flex)		LKD9A9023310000



# MegaLine® Connect100 JACK MODULES

Category 7A<sub>6</sub>A



Jack module  
Cat. 7<sub>A</sub> (bis 2 GHz)

## MegaLine® Connect100 jack module 4K7A

### Description

For transmitting analogue and digital voice, image and data signals. The performance features correspond to category 7<sub>A</sub> (up to 2 GHz).

### Structure

Material	Full metal; die-cast zinc, nickel-plated
Installation dimensions	MC100 format
Wiring	4 pairs via cable plug
Connection	Socket 4K7A (TERA®)

### Standards

- ▶ ISO/IEC 11801
- ▶ EN 50173-1
- ▶ EN 61076-3-104
- ▶ IEEE 802.3bt (4PPoE)

Article	Cat.	Order no.
MegaLine® Connect100 Jack module 4K7A – white	Cat. 7 <sub>A</sub> (up to 2 GHz)	LKD9A9020300000



Jack module  
Cat. 6<sub>A</sub>

## MegaLine® Connect100 jack module RJ45

### Description

For transmitting analogue and digital voice, image and data signals. The performance features correspond to category 6<sub>A</sub> up to 500 MHz.

### Structure

Material	Full metal; die-cast zinc, nickel-plated
Installation dimensions	MC100 format
Wiring	4 pairs via cable plug
Connection	RJ45 socket

### Standards

- ▶ ISO/IEC 11801
- ▶ EN 50173-1
- ▶ IEC 60603-7-51
- ▶ IEEE 802.3bt (4PPoE)

Article	Category	Order no.
MegaLine® Connect100 jack module RJ45 – aqua	Cat. 6 <sub>A</sub>	LKD9A9020100000

# MegaLine® Connect100 INTERFACE

Category 7<sub>A</sub> (up to 2 GHz)

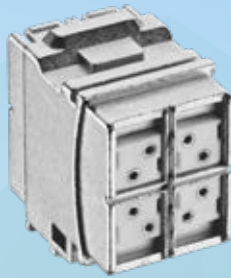

## MegaLine® Connect100 Interface

### Description

For transmitting analogue and digital voice, image and data signals. The performance features correspond to category 7<sub>A</sub> (up to 2 GHz).

### Structure

Material	Full metal; die-cast zinc, nickel-plated
Installation dimensions	MC100 format
Wiring	4 pairs via cable plug
Connection	Interface socket

### Standards

- ▶ ISO/IEC 11801
- ▶ EN 50173-1
- ▶ IEEE 802.3bt (4PPoE)

Article	Cat.	Order no.
MegaLine® Connect100 Interface	Cat. 7 <sub>A</sub> (up to 2 GHz)	LKD9A9020500000

## MegaLine® Connect100

Interface connector solid / flex

### Description

For transmitting analogue and digital voice, image and data signals. The performance features correspond to category 7<sub>A</sub> (up to 2 GHz).

### Structure

Material	Full metal; die-cast zinc, nickel-plated
Wiring	4 pairs via cable plug
Connection	Interface connector

### Standards

- ▶ ISO/IEC 11801
- ▶ EN 50173-1
- ▶ IEEE 802.3bt (4PPoE)

Article	Cat.	Order no.
MegaLine® Connect100 Interface connector solid (AWG24–22)	Cat. 7 <sub>A</sub> (up to 2 GHz)	LKD9A9020510000
MegaLine® Connect100 Interface connector flex (AWG27–26)		LKD9A9020520000

# MegaLine® Connect100 WALL OUTLETS

For MegaLine® Connect100 jack modules



Fig. 1  
50 x 50 / 1-fold  
wall outlet



Fig. 2  
50 x 50 / 2-fold  
wall outlet



Fig. 3  
50 x 50 / 3-fold  
wall outlet



Fig. 4  
45 x 45 / 1-fold  
wall outlet  
(similar to figure)



Fig. 5  
45 x 45 / 2-fold  
wall outlet (similar to figure)

## MegaLine® Connect100 50 x 50 wall outlets

### German style

Wall outlets for installation in commercially available 50 x 50-mm

cover frames for equipping with **MegaLine® Connect100** jack modules. Compatible with **MegaLine® Connect45** jack modules (VK format).

#### housing

Housing body	Full metal; die-cast zinc, nickel-plated
Colours	Pure white, RAL 9010
labelling	via labelling field

#### Installation dimensions

50 mm x 50 mm (H x W), downward inclination of 30°

#### Accessories (optional)

**MegaLine® Connect100** 1-fold and 2-fold cover frame

40 mm surface-mounted housing incl. 1-fold flush-mounted cover frame

Spacer frame for 1-fold surface-mounted housing, 10 mm

## MegaLine® Connect100 45 x 45 wall outlets

### French design

Wall outlets for equipping with **MegaLine® Connect100** jack modules.

#### housing











Housing body	Plastic
Colours	Pure white, RAL 9010
labelling	via labelling field

#### Installation dimensions

45 mm x 45 mm x 42 mm (H x W x D), downward inclination 30°

#### Accessories (optional)

**VarioLine®** cover frame

Fig.	Article	Colour	Order no.
1	 <b>MegaLine® Connect100</b> wall outlet 50 x 50 / 1-fold (1 pc.)	◇ Pure white, RAL 9010	LKD9A4601070000
2	 <b>MegaLine® Connect100</b> wall outlet 50 x 50 / 2-fold (1 pc.)		LKD9A4601080000
3	 <b>MegaLine® Connect100</b> wall outlet 50 x 50 / 3-fold (1 pc.)		LKD9A4601090000
-	 Flush-mounted cover frame, 1-fold (1 pc.)	◇ Pure white, RAL 9010	LKD9A4100030000
-	 Flush-mounted cover frame, 2-fold (1 pc.)		LKD9A4100050000
-	 Surface-mounted housing 40 mm incl. UP-cover frame 1-fold (1 pc.)		LKD9A4600860000
-	 Spacer frame for surface-mounted housing 1-fold 10 mm (1 pc.)		LKD9A4600880000
1	 <b>MegaLine® Connect100</b> wall outlet 45 x 45 / 1-fold	◇ Pure white, RAL 9010	LKD9A9011010000
2	 <b>MegaLine® Connect100</b> wall outlet 45 x 45 / 2-fold		LKD9A9011000000
3	 <b>VarioLine®</b> cover frame 45 x 45 (8 pcs.)		LKD9ZE800130000

## MegaLine® Connect100 PATCH PANEL 19"

## MegaLine® Connect100 DIN RAIL HOUSING



### MegaLine® Connect100 patch panel 19" 24-Port

#### Description

19" patch panel for mounting 24x **MegaLine®** Connect100 jack modules.

#### Structure

housing	Sheet steel
Colour	Light grey, RAL 7035 Jet black, RAL 9005
labelling	1–24
Capacity	Max. 24 jack modules: 4K7A / 8C7A / RJ45
Strain relief	Via cable ties
EPB connection	Cable lug on threaded bolt
Cable entrance	Over the entire width of the cable management rail
Structure	24 ports

#### Dimensions

19" / 1 RU  
100 mm installation depth

Article	Colour	Order no.
<b>MegaLine®</b> Connect100 patch panel 19" / 24 port (1 pc.)	◆ Light grey RAL 7035	LKD9A9022010000
	◆ Jet black RAL 9005	LKD9A9022020000
	◆ Stainless steel	LKD9A6700250000

### MegaLine® Connect100 DIN rail housing 2-fold

#### Description

DIN rail housing to accommodate 2x **MegaLine®** Connect100 jack modules.

#### Structure

Material	Sheet steel, powder coated
Colour	Light grey, RAL 7035
Capacity	max. 2 <b>MegaLine®</b> Connect100 jack modules

#### Dimensions

85 mm x 35 mm x 95 mm (H x W x D)

Article	Order no.
<b>MegaLine®</b> Connect100 DIN rail housing, 2-fold (1 pc.)	LKD9A4600970000

# MegaLine®

## ACCESSORIES AND CABLE ASSEMBLY TOOLS



**MegaLine® Connect100 assembly tool**

### Description

Simplifies aligning and trimming conductor pairs when assembling **MegaLine® Connect100** cable plugs or interface plugs (cross design).

Article	PU	Order no.
<b>MegaLine® Connect100 assembly tool</b>	10 pc.	LKD9A9040010000
<b>MegaLine® Connect100 assembly tool cross</b>		LKD9A9040090000



**MegaLine® Connect100 crimping tool**

### Description

For easy assembly of jack modules with the plug and wire manager.

Article	PU	Order no.
<b>MegaLine® Connect100 crimping tool</b>	1 pc.	LKD9A9040070000

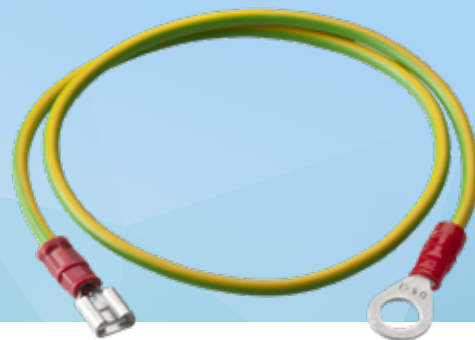

**Example of or earthing cable**

### Description







We recommend using suitable equipotential bonding conductors according to EN 50310 to create conductive connections for our 19" patch panels in cabinets for IT facilities and data wall sockets.

# MegaLine® Connect45 Pro Plus MegaLine® Connect45 Pro MegaLine® Connect45 Pro Plus ELine COPPER CONNECTION TECHNOLOGY



# MegaLine® Connect45 Pro

The cabling system from 10 – 40 Gbit/s

MegaLine® Connect45 Pro – the cabling system from 1–10 Gbit/s		Page
	<b>MegaLine® Connect45 Pro – the modular connection technology</b>	Connection technology can be this simple 120
	<b>Installation options</b>	121
	<b>Two technologies – one solution ... from 1 – 10 Gbit/s</b>	System overview 122
	<b>Connect45 Pro Plus jack modules</b>	• Keystone format • ELine format 124
	<b>Connect45 Pro jack modules</b>	• Keystone format BM ISO/IEC • BM 90° adapter Cat. 6 <sub>A</sub> Cat. 6 <sub>A</sub> 125
	<b>19" Connect45 Pro patch panels</b>	• Keystone format • ELine format 126
	<b>Connect45 Pro</b>	• Keystone format DIN rail adapters • Keystone format wall outlets 127
	<b>Office</b>	
	<b>Data centres</b>	

# MegaLine® Connect45 Pro - THE MODULAR CONNECTION TECHNOLOGY

Connection technology can be this simple

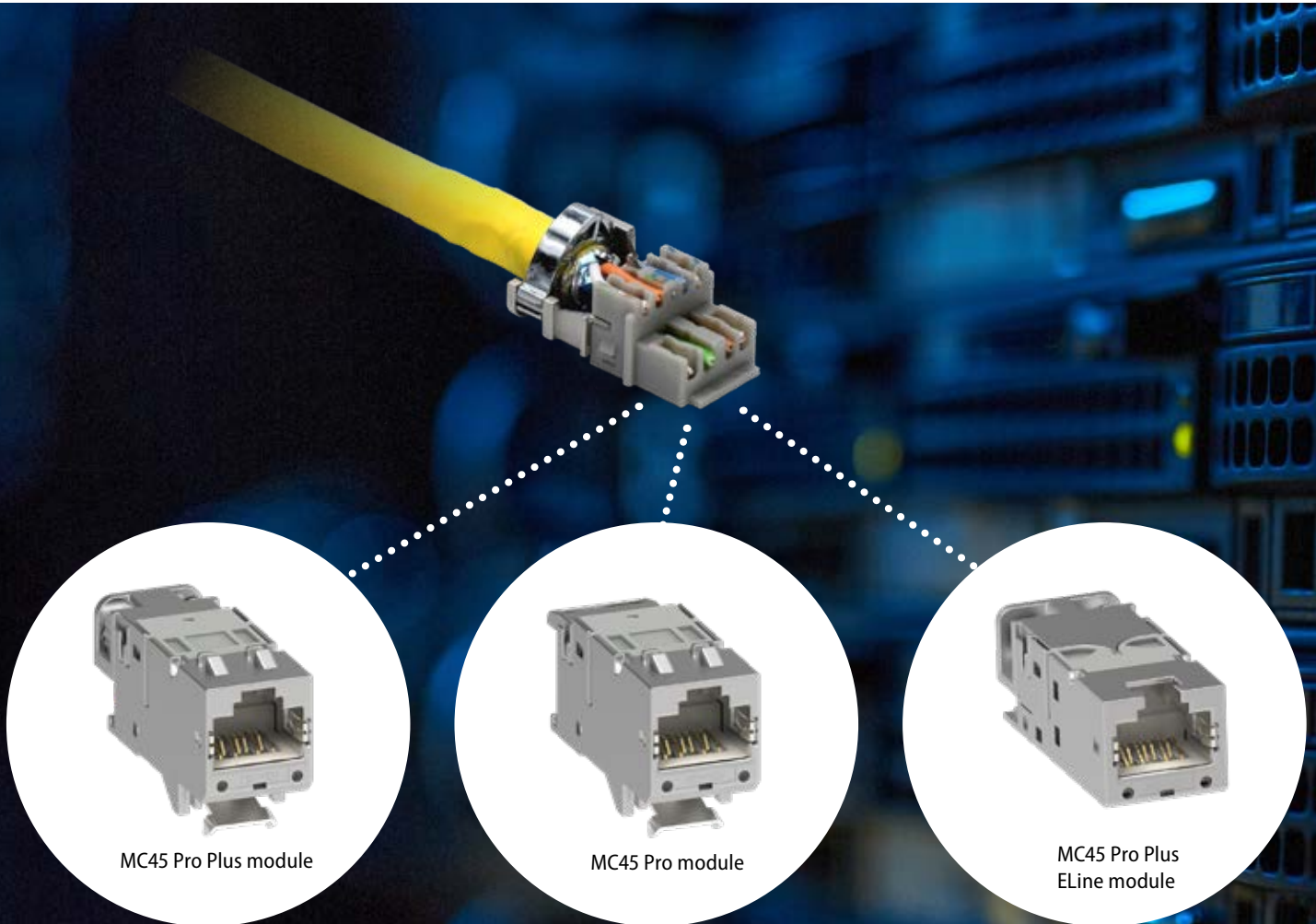

## BENEFITS

- ▶ Quick, tool-free installation
- ▶ Maximum reserve capacity
- ▶ 360° shield contact
- ▶ Robust, variable strain relief
- ▶ GHMT PVP production monitoring
- ▶ 4PPoE certified
- ▶ Comprehensive system range

## MegaLine® Connect 45 Pro Plus SYSTEM OVERVIEW

Our RJ45 jack modules comply with Category 6<sub>A</sub> and guarantee transmission class E<sub>A</sub> in the link with a transmission speed of 10 Gbit/s (10GBase-T).

The quality and performance of our products are subject to external monitoring by the DAkkS-accredited GHMT Premium Verification Program.

Only commercially available tools are required to install the data cables in the easy-to-use Wire Manager; fast and safe installation is guaranteed.



# INSTALLATION OPTIONS

DCLink – the real Plug&Play solution

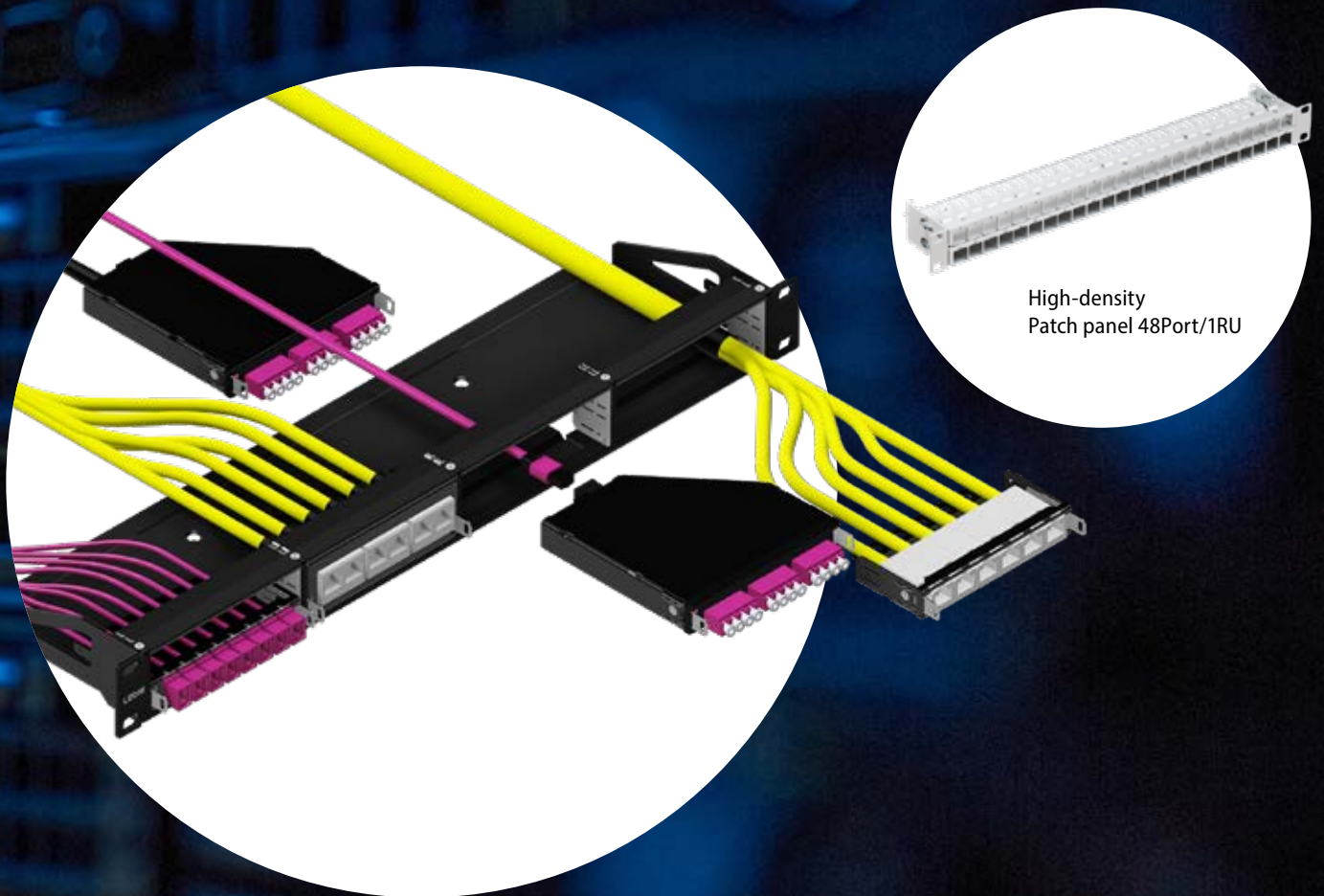

High-density  
Patch panel 48Port/1RU

The special design of the integrated strain relief ratchet clamp is adapted to the different cable diameters of installation and connection cables. Special attention was paid to ensuring that the cable strain relief on the jack module is robust and guaranteeing reliable 360° shield contact.

In addition to the conventional Keystone format, we can also produce the packing densities required in data centres with our well-known ELine format. As a component of the **MegaLine® Connect45 Pro** product family, full compatibility with our DCLink and **VarioLine®** installation systems for applications in the office, data centre and industry is a vital part of our system strategy.

## Summary

**No matter how your network is structured, the full range of options is now available to you.**

**MegaLine® Connect45 Pro Plus – the 1–10 Gbit/s cabling system for speedy installation, maximum flexibility and maximum performance.**

# TWO TECHNOLOGIES – ONE SOLUTION ... FROM 1 – 10 GBIT/S

## System overview

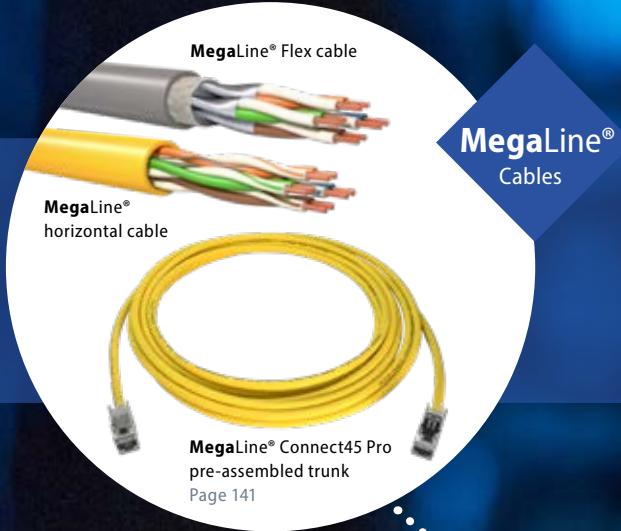

1 Gbit/s

1-10 Gbit/s

For data rates up to

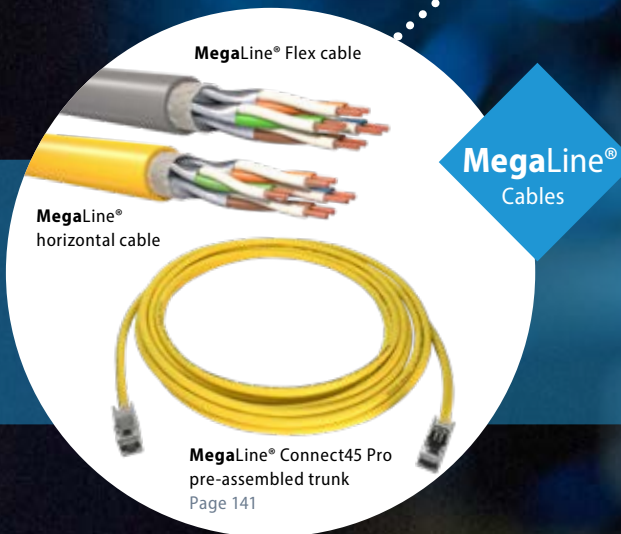

### Unshielded cabling system Cat. 6/Class E



Wall outlets  
Page 127



VarioLine® UF  
underfloor systems  
Page 151



VarioLine® CP  
Consolidation Point housing  
Page 148



MegaLine® Connect45 Pro  
24-port patch panel 19" / 1 RU  
straight  
Page 126

### Shielded cabling system Cat. 6<sub>A</sub> / Class E<sub>A</sub>

Unshielded  
1 Gbit/s



MegaLine®  
RJ45 patch cord Cat.6  
Unshielded  
Page 130

1 Gbit/s

1-10 Gbit/s

shielded  
10 Gbit/s



MegaLine®  
RJ45 patch cord Cat. 6<sub>A</sub>,  
shielded Page 133

# MegaLine® Connect45 Pro Plus JACK MODULES



**MegaLine® Connect45 Pro Plus jack module category 6<sub>A</sub> ISO/IEC Keystone format**

## Description

For transmitting analogue and digital voice, image and data signals. The performance features are the same as for Cat. 6<sub>A</sub> (ISO/IEC) up to 500 MHz. Class E<sub>A</sub> requirements for channels and permanent links according to ISO/IEC 11801, 3rd edition are met starting from 1 metre.

The length specifications relate to the 2-connector model.

## Structure

Material	Full metal; die-cast zinc, nickel-plated
Wiring	4 pairs, tool-free
Connection	RJ45 socket
Shield connection	360° contact
Strain relief	Snap-on clamp (resealable)

## Standards

- ▶ ISO/IEC 11801
- ▶ EN 50173-1
- ▶ IEC 60603-7-51
- ▶ IEEE 802.3bt (4PPoE)

Article	PU	Marking	Order no.
MegaLine® Connect45 Pro Plus jack module Cat. 6 <sub>A</sub> ISO/IEC	24 pc.	White	LKD9ZQ010040024



**MegaLine® Connect45 Pro Plus ELine jack module category 6<sub>A</sub> ISO/IEC Eline format**

## Description

For transmitting analogue and digital voice, image and data signals. The performance features are the same as for Cat. 6<sub>A</sub> (ISO/IEC) up to 500 MHz. Class E<sub>A</sub> requirements for channels and permanent links according to ISO/IEC 11801, 3rd edition are met starting from 1 metre.

The length specifications relate to the 2-connector model.

## Structure

Material	Full metal; die-cast zinc, nickel-plated
Wiring	4 pairs via cable plug
Connection	RJ45 socket
Shield connection	360° contact
Strain relief	Snap-on clamp (resealable)

## Standards

- ▶ ISO/IEC 11801
- ▶ EN 50173-1
- ▶ IEC 60603-7-51

Article	PU	Marking	Order no.
MegaLine® Connect45 Pro Plus ELine jack module Cat. 6 <sub>A</sub> ISO/IEC	24 pc.	White	LKD9ZQ010050024

# MegaLine® Connect45 Pro JACK MODULE

Category 6<sub>A</sub>



**MegaLine® Connect45 Pro jack module**  
category 6<sub>A</sub> ISO/IEC Keystone format

## Description

For transmitting analogue and digital voice, image and data signals. The performance features are the same as for Cat. 6<sub>A</sub> (ISO/IEC) up to 500 MHz. Class E<sub>A</sub> requirements for channels and permanent links according to ISO/IEC 11801, 3rd edition are met starting from 1 metre.

The length specifications relate to the 2-connector model.

## Structure

Material	Full metal; die-cast zinc, nickel-plated
Wiring	4 pairs, tool-free
Connection	RJ45 socket

## Standards

- ▶ ISO/IEC 11801
- ▶ EN 50173-1
- ▶ IEC 60603-7-51
- ▶ IEEE 802.3bt (4PPoE)

Article	PU	Marking	Order no.
MegaLine® Connect45 Pro BM ISO/IEC	50 pc.	White	LKD9ZQ010000000



**MegaLine® Connect45 Pro 90° adapter**

## Description

Simple plug in to the MegaLine® Connect45 Pro jack. This enables installation where space is limited (e.g. wall channel) at a 90° angle.

## Structure

Material	Full metal; die-cast zinc, nickel-plated
----------	--

Article	PU	Order no.
MegaLine® Connect45 Pro 90° adapter	20 pc.	LKD9ZQ010010000

# MegaLine® Connect45 Pro PATCH PANELS 19"

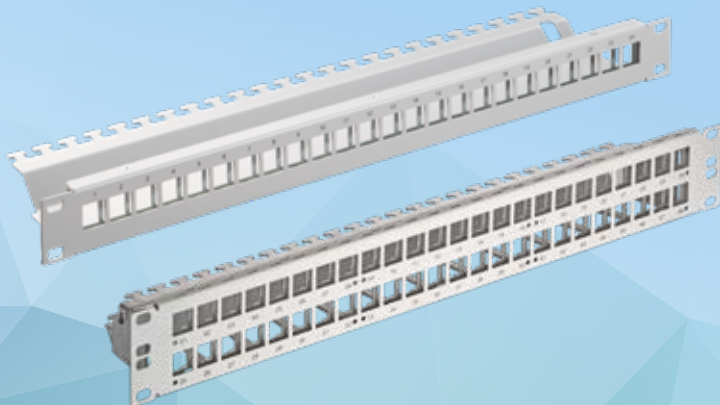

**MegaLine® Connect45 Pro patch panel 19"**  
Keystone format

## Description

The patch panel can be equipped with 24/48 jack modules in Keystone format.

## Structure

housing	Full metal
Colour	Grey, black, stainless steel
Capacity	24/48 jack modules in Keystone format
EPB connection	Cable lug on threaded bolt
Strain relief	Via cable ties
Cable entrance	Over the entire width of the cable management rail

## Dimensions

19" / 1 RU, 110 mm installation depth (24 ports)  
19" / 1.5 RU, 114.5 mm installation depth (48 ports)

Article	Colour	Order no.
<b>MegaLine® Connect45 Pro</b> Patch panel 19" with 24 Keystone	◆ Light grey RAL 7035	LKD9A5012000000
	◆ Jet black RAL 9005	LKD9A5012010000
	◆ Stainless steel	LKD9A5012060000
<b>MegaLine® Connect45 Pro 1.5 RU</b> Patch panel 19" with 48 Keystone	◆ Light grey RAL 7035	LKD9A5012050000

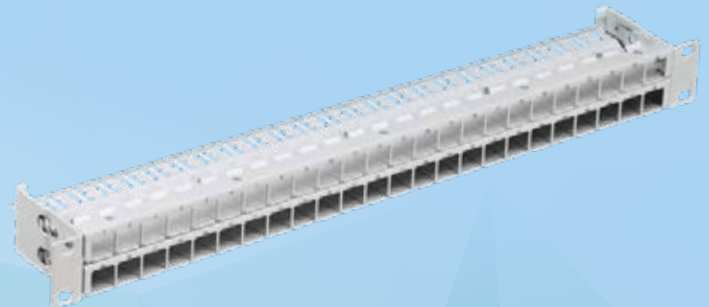

**MegaLine® Connect45 Pro patch panel 19"**  
48 port, ELine format, 1 RU

## Description

High-density patch panel for 48 jack modules in one rack unit

## Structure

housing	Full metal
Colour	Grey, black
Capacity	48 jack modules in ELine format
EPB connection	Cable lug on threaded bolt
Strain relief	Via cable ties
Cable entrance	Over the entire width of the cable management rail

## Dimensions

19" / 1 RU, 110 mm installation depth

Article	Colour	Order no.
<b>MegaLine® Connect45 Pro 1.5 RU</b> patch panel 19" with 48 Port ELine	◆ Light grey RAL 7035	LKD9A5052060000
	◆ Jet black RAL 9005	LKD9A5052070000

## MegaLine® Connect45 Pro DIN RAIL CLIP

for Keystone jack modules



### MegaLine® Connect45 Pro DIN rail adapter in Keystone format

#### Description

DIN rail housing with label field and side cover to accommodate one **MegaLine® Connect45 Pro** jack module. It is installed by snapping it onto a 35-mm

DIN rail (EN 60715) and is compatible with SLS switch covers (width = modular width MW). Mounts for FO flange couplings are pre-fitted.

#### Structure

Housing body	Plastic housing with steel spring
Colours	Light grey, RAL 7035
labelling	Labelling field with transparent cover

#### Dimensions

Approx. 18 mm x 68 mm x 69 mm (H x W x D),  
downward inclination 45°

Article	Colour	Order no.
<b>MegaLine® Connect45 Pro</b> DIN rail clip Keystone	◆ Light grey RAL 7035	LKD9ZQ010180000

## MegaLine® Connect45 Pro WALL OUTLETS

for Keystone jack modules



### MegaLine® Connect45 Pro Keystone format 50 x 50 wall outlet

#### Description

Wall outlet in choice of designs with central window and cover frame to accommodate **MegaLine® Connect45 Pro** jack modules.

#### Structure

Housing body	Full metal; die-cast zinc, nickel-plated
Covers	Polycarbonate
Colours	Pure white, similar to RAL 9010
labelling	Labelling field with transparent cover

#### Dimensions















Housing body approx. 70 mm x 70 mm x 19 mm (W x H x D)  
Central window approx. 50 mm x 50 mm x 13 mm (W x H x D)  
Cover frame approx. 80 mm x 80 mm x 6 mm (W x H x D)

Article	Colour	Order no.
<b>MegaLine® Connect45 Pro</b> wall outlet 50x50 1-fold Keystone	◇ Pure white, similar to RAL 9010	LKD9ZQ010100000
<b>MegaLine® Connect45 Pro</b> wall outlet 50x50 2-fold Keystone	◇ Pure white, similar to RAL 9010	LKD9ZQ010110000
<b>MegaLine® Connect45 Pro</b> wall outlet 50x50 3-fold Keystone	◇ Pure white, similar to RAL 9010	LKD9ZQ010120000
<b>MegaLine® Connect45 Pro</b> surface-mounted housing 80x80x40 mm	◇ Pure white, similar to RAL 9010	LKD9ZQ010190000
<b>MegaLine® Connect45 Pro</b> wall outlet UP/0 without cover 1/3-fold Keystone	◆ Plain zinc	LKD9ZQ010160000
<b>MegaLine® Connect45 Pro</b> wall outlet UP/0 without cover 2-fold Keystone	◆ Plain zinc	LKD9ZQ010170000

# MegaLine® COPPER PATCH CORDS / TRUNK CABLES





MegaLine® copper patch cords / trunk cables			Page
	Patch cord RJ45/RJ45	Cat. 5 / 100 MHz	130
	Patch cord RJ45/RJ45	Cat. 6 / 250 MHz	131
	Patch cord RJ45/RJ45	Cat. 6 <sub>A</sub> / 500 MHz	133
	Industrial RJ45/RJ45 patch cord	Cat. 5 / 100 MHz	134
	Industrial RJ45/RJ45 patch cord	Cat. 6 / 250 MHz	135
	Trunk cables	Cat. 7 <sub>A</sub>	136
	CP cable	Cat. 7 <sub>A</sub>	137
	Patch cord TERA®	-	138
	Trunk cables	Multi	140
	Trunk cables	Cat. 6 <sub>A</sub> module	141
	Consolidation Point cables	Multi	142
	Consolidation Point cables	Cat. 6 <sub>A</sub> module	143
	Office cables		
	Data centre cables		
	Industrial cables		

# MegaLine® RJ45/RJ45 PATCH CORD CAT. 5/100 MHZ

shielded, Cat. 5, Class D with coloured moulded boot



## MegaLine® Patch 5D-RJ45

### Description

The cable type used is suitable for transmission rates of up to 100 MHz. The pair shielding and the high-coverage copper braiding as overall shielding ensure excellent NEXT and impedance values.

The patch and connection cables are fitted at both ends with a shielded RJ45 plug and an overmoulded boot.

### Applications

IEEE 802.3, 10Base-T, 100Base-T, 1000Base-T, IEEE 802.5 16MB ISDN, FDDI, ATM

### Properties / construction

### EMC

RJ45 plug

Electrical values

Assignment

Standards

Foil overall shielding

EN 60603-7

Cat. 5, Class D

1:1

ISO/IEC 11801 / EN 50173

RoHS compliant with 2011/65/EU

### Fire behaviour

Flame resistance

IEC 60332-1-2

### Accessories

MegaLine® Patch RJ45 with marking ring

in various colours for colour-coding the patch cords

Length m	Article	Order no.				
		Grey (PVC)	Blue (PVC)	Turquoise green (LSOH)	Yellow (PVC)	Red (PVC)
0.5	MegaLine® 5D-RJ45 patch cord	LKD9AA104000000	LKD9AA104100000	LKD9AA104200000	LKD9AA104300000	LKD9AA104400000
1.0		LKD9AA104010000	LKD9AA104110000	LKD9AA104210000	LKD9AA104310000	LKD9AA104410000
1.5		LKD9AA104020000	LKD9AA104120000	LKD9AA104220000	LKD9AA104320000	LKD9AA104420000
2.0		LKD9AA104030000	LKD9AA104130000	LKD9AA104230000	LKD9AA104330000	LKD9AA104430000
2.5		LKD9AA104040000	LKD9AA104140000	LKD9AA104240000	LKD9AA104340000	LKD9AA104440000
3.0		LKD9AA104050000	LKD9AA104150000	LKD9AA104250000	LKD9AA104350000	LKD9AA104450000
4.0		LKD9AA104060000	LKD9AA104160000	LKD9AA104260000	LKD9AA104360000	LKD9AA104460000
5.0		LKD9AA104070000	LKD9AA104170000	LKD9AA104270000	LKD9AA104370000	LKD9AA104470000
7.5		LKD9AA104080000	LKD9AA104180000	LKD9AA104280000	LKD9AA104380000	LKD9AA104480000
10.0		LKD9AA104090000	LKD9AA104190000	LKD9AA104290000	LKD9AA104390000	LKD9AA104490000

Other lengths on request

# MegaLine® RJ45/RJ45 PATCH CORD CAT. 6/250 MHZ

unshielded, Cat. 6, Class E with grey moulded boot



## MegaLine® Patch 6E-RJ45U

### Description

The cable type used is suitable for transmission rates of up to 250 MHz. Due to its construction, the patch cord offers outstanding NEXT and XT return losses.

The patch and connection cables are fitted at both ends with a shielded RJ45 plug and an overmoulded boot.

### Applications

IEEE 802.3, 10Base-T, 100Base-T, 1000Base-T, IEEE 802.5 16MB, ISDN, FDDI, ATM

### Properties / construction

RJ45 plug	EN 60603-7
Electrical values	Cat. 6, Class E
Assignment	1:1
Standards	ISO/IEC 11801/ EN 50173 RoHS compliant with 2011/65/EU

### Fire behaviour

Smoke density	IEC 61034
Halogen content	IEC 60754-2
Flame resistance	IEC 60332-1-2

### Accessories

**MegaLine® Patch RJ45 with marking ring**  
in various colours for colour-coding the patch cords

Length	Article	Order no.
m		Grey (LSOH)
0.5	MegaLine® Patch RJ45U	LKD9AA500270000
1.0		LKD9AA500280000
1.5		LKD9AA500290000
2.0		LKD9AA500300000
2.5		LKD9AA500310000
3.0		LKD9AA500320000
4.0		LKD9AA500330000
5.0		LKD9AA500340000
7.5		LKD9AA500350000
10.0		LKD9AA500360000

Additional lengths on request

# MegaLine® RJ45/RJ45 PATCH CORD CAT. 6/250 MHZ

shielded, Cat. 6, Class E<sub>A</sub> with coloured moulded boot



## MegaLine® Patch 6EA-RJ45

### Description

This cable is suitable for transmission frequencies of up to 250 MHz. The pair shielding and the high-coverage copper braiding as overall shielding ensure excellent NEXT and return loss values.

The patch and connection cables are fitted at both ends with a shielded RJ45 plug and an overmoulded boot.

### Applications

Suitable for IEEE 802.3, 10Base-T, 100Base-T, 1000Base-T, 10GBase-T,

IEEE 802.5 16MB, ISDN, FDDI, ATM

### Properties / construction

EMC	Combined shielding (PiMf + braiding)
RJ45 plug	EN 60603-7
Electrical values	Cat. 6, Class E <sub>A</sub>
Assignment	1:1
Standards	ISO/IEC 11801 / EN 50173
	RoHS compliant with 2011/65/EU

### Fire behaviour

Smoke density	IEC 61034
Halogen content	IEC 60754-2
Flame resistance	IEC 60332-1-2

### Accessories

MegaLine® Patch RJ45 with marking ring  
in various colours for colour-coding the patch cords

Length	Article	Order no.				
		Grey (LSOH)	Blue (LSOH)	Turquoise green (LSOH)	Yellow (LSOH)	Red (LSOH)
0.5	MegaLine® 6EA-RJ45 patch cord	LKD9AA211320000	LKD9AA211520000	LKD9AA211620000	LKD9AA211420000	LKD9AA211720000
1.0		LKD9AA211330000	LKD9AA211530000	LKD9AA211630000	LKD9AA211430000	LKD9AA211730000
1.5		LKD9AA211340000	LKD9AA211540000	LKD9AA211640000	LKD9AA211440000	LKD9AA211740000
2.0		LKD9AA211350000	LKD9AA211550000	LKD9AA211650000	LKD9AA211450000	LKD9AA211750000
2.5		LKD9AA211360000	LKD9AA211560000	LKD9AA211660000	LKD9AA211460000	LKD AA211760000
3.0		LKD9AA211370000	LKD9AA211570000	LKD9AA211670000	LKD9AA211470000	LKD9AA211770000
4.0		LKD9AA211380000	LKD9AA211580000	LKD9AA211680000	LKD9AA211480000	LKD9AA211780000
5.0		LKD9AA211390000	LKD9AA211590000	LKD9AA211690000	LKD9AA211490000	LKD9AA211790000
7.5		LKD9AA211400000	LKD9AA211600000	LKD9AA211700000	LKD9AA211500000	LKD9AA211800000
10.0		LKD9AA211410000	LKD9AA211610000	LKD9AA211710000	LKD9AA211510000	LKD9AA211810000

Other lengths on request

# MegaLine® RJ45/RJ45 PATCH CORD CAT. 6<sub>A</sub>/500 MHZ

shielded, Cat. 6<sub>A</sub>, Class E<sub>A</sub> with coloured moulded boot

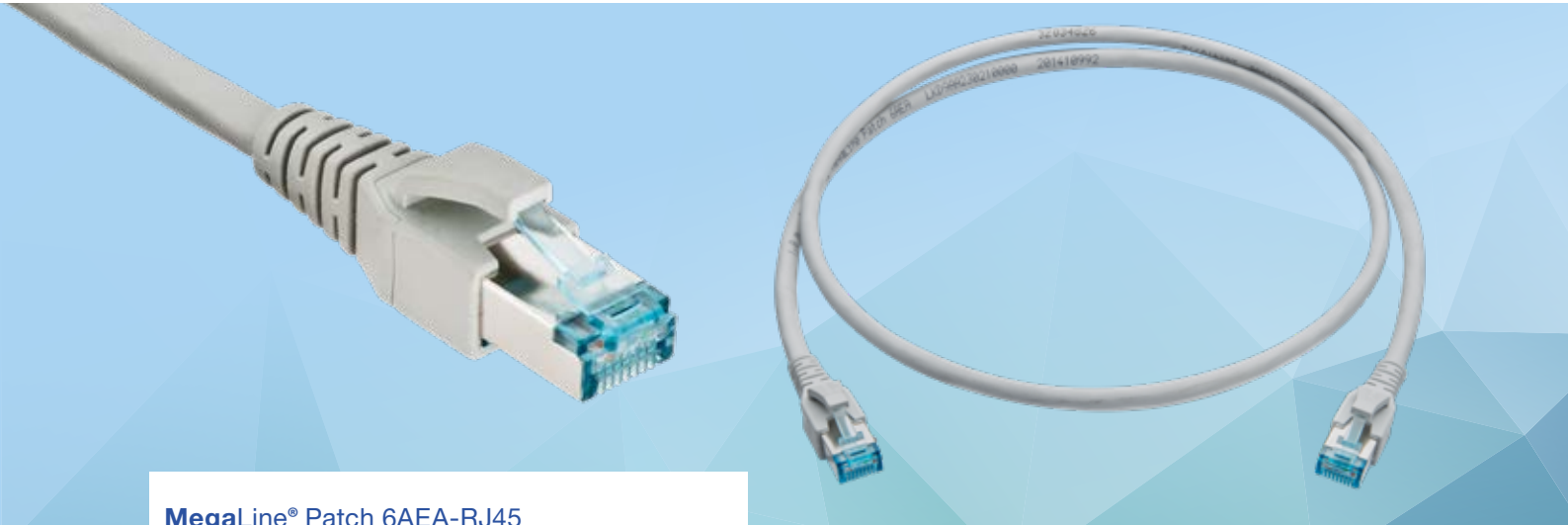

## MegaLine® Patch 6AEA-RJ45

### Description

This cable is suitable for transmission frequencies of up to 500 MHz. The pair shielding and the high-coverage copper braiding as overall shielding ensure excellent NEXT and return loss values.

The patch and connection cables are fitted at both ends with a shielded RJ45 plug and an overmoulded boot.

### Applications

Installation cable for use in structured cabling systems according to ISO/IEC 11801 and EN 50173-x. Ideal for all applications up to Class E<sub>A</sub> (video, data, telephony) >10 GbE in line with IEEE 802.3an, cable sharing, VoIP, PoE.

### Properties / construction

EMC	Combined shielding (PiMf + braiding)
RJ45 plug	EN 60603-7
Electrical values	Cat. 6 <sub>A</sub> , Class E <sub>A</sub>
Assignment	1:1
Standards	ISO/IEC 11801 / EN 50173
	RoHS compliant with 2011/65/EU

### Fire behaviour

Smoke density	IEC 61034
Halogen content	IEC 60754-2
Flame resistance	IEC 60332-1-2

### Accessories

**MegaLine® Patch RJ45 with marking ring**  
in various colours for colour-coding the patch cords

Length m	Article	Order no.				
		Grey (LSOH)	Blue (LSOH)	Turquoise green (LSOH)	Yellow (LSOH)	Red (LSOH)
0.5	MegaLine® 6AEA-RJ45 patch cord	LKD9AA230200000	LKD9AA230300000	LKD9AA230400000	LKD9AA230500000	LKD9AA230600000
1.0		LKD9AA230210000	LKD9AA230310000	LKD9AA230410000	LKD9AA230510000	LKD9AA230610000
1.5		LKD9AA230220000	LKD9AA230320000	LKD9AA230420000	LKD9AA230520000	LKD9AA230620000
2.0		LKD9AA230230000	LKD9AA230330000	LKD9AA230430000	LKD9AA230530000	LKD9AA230630000
2.5		LKD9AA230240000	LKD9AA230340000	LKD9AA230440000	LKD9AA230540000	LKD9AA230640000
3.0		LKD9AA230250000	LKD9AA230350000	LKD9AA230450000	LKD9AA230550000	LKD9AA230650000
4.0		LKD9AA230260000	LKD9AA230360000	LKD9AA230460000	LKD9AA230560000	LKD9AA230660000
5.0		LKD9AA230270000	LKD9AA230370000	LKD9AA230470000	LKD9AA230570000	LKD9AA230670000
7.5		LKD9AA230280000	LKD9AA230380000	LKD9AA230480000	LKD9AA230580000	LKD9AA230680000
10.0		LKD9AA230290000	LKD9AA230390000	LKD9AA230490000	LKD9AA230590000	LKD9AA230690000

Additional lengths on request

# MegaLine® RJ45/RJ45 INDUSTRIAL PATCH CORD CAT. 5/100 MHZ

shielded, Cat. 5, Class D, with yellow Hirose plug



## MegaLine® Patch Industry 5D-RJ45

### Description

This cable is suitable for transmission frequencies of up to 100 MHz. The pair shielding and the high-coverage copper braiding as overall shielding ensure excellent NEXT and return loss values.

The patch and connection cables are fitted at both ends with a shielded RJ45 plug and boot.

The superflex design is ideal for tough industrial applications (e.g. Drag chains).

### Applications

IEEE 802.3, 10Base-T, 100Base-T, 1000Base-T, IEEE 802.5 16MB, ISDN, FDDI, ATM

### Properties / construction

EMC	Shield (braid)
RJ45 plug	EN 60603-7
Electrical values	Cat. 5, Class D
Cable/boot	Yellow (PUR superflex) / yellow
Standards	ISO/IEC 11801 / EN 50173
	RoHS compliant with 2011/65/EU

### Fire behaviour

Smoke density	IEC 61034-1/2
Halogen content	IEC 60754-1/2
Flame resistance	IEC 60332-2-2

Length	Article	Order no.
m		Yellow (PUR)
10.0	MegaLine® Patch Industry 5D-RJ45	LKD9AA700840000
20.0		LKD9AA701550000
30.0		LKD9AA700820000
40.0		LKD9AA701790000
50.0		LKD9AA700850000

Other lengths on request

# MegaLine® RJ45/RJ45 INDUSTRIAL PATCH CORD CAT. 6/250 MHZ

shielded, Cat. 6, Class E<sub>A</sub> with black moulded boot



## MegaLine® Patch Industry 6EA-RJ45

### Description

This cable is suitable for transmission frequencies of up to 250 MHz. The pair shielding and the high-coverage copper braiding as overall shielding ensure excellent NEXT and return loss values.

The patch and connection cables are fitted at both ends with a shielded RJ45 plug.

### Applications

Suitable for IEEE 802.3, 10Base-T, 100Base-T, 1000Base-T, 10GBase-T, IEEE 802.5 16MB, ISDN, FDDI, ATM

### Properties / construction

EMC	Combined shielding (PiMf + braiding)
RJ45 plug	EN 60603-7
Electrical values	Cat. 6, Class E <sub>A</sub>
Cable/boot	yellow (PUR) / black
Standards	ISO/IEC 11801 / EN 50173
	RoHS compliant with 2011/65/EU

### Fire behaviour

Smoke density	IEC 61034-1/2
Halogen content	IEC 60754-1/2
Flame resistance	IEC 60332-2-2

### Accessories

See page 161 for description

### MegaLine® Patch RJ45 with marking ring

in various colours for colour-coding the patch cords

Length	Article	Order no.
m		<b>Yellow</b>
0.5	MegaLine® Patch Industry 6EA-RJ45	LKD9AA701600000
1.0		LKD9AA701610000
1.5		LKD9AA701620000
2.0		LKD9AA701630000
2.5		LKD9AA701640000
3.0		LKD9AA701650000
5.0		LKD9AA701660000
7.5		LKD9AA701670000
10.0		LKD9AA701680000

Other lengths on request

# MegaLine® Connect100

Pre-assembled trunk & pre-assembled CP cables

On request, with documented acceptance measurement as a PDF file.



## MegaLine® Connect100 trunk cable, Cat.7<sub>A</sub>

### Description

The trunk cable is based on a G20 S/F data cable – preassembled at both ends with **MegaLine® Connect100** cable plugs Cat 7<sub>A</sub>. Thanks to its high-quality components, the preassembled cable fulfils the requirements for permanent links (**type > 5 m, Cat. 7<sub>A</sub> module**) of Class F<sub>A</sub> according to ISO/IEC 11801 and EN 50173 for 10 Gigabit Ethernet as well as channels (Class II) according to the current draft of ISO/IEC 11801-99-1.

### Channel Class II

- ▶ Recommended minimum configuration:  
5 m horizontal cable plus 2 m patch cord
- ▶ Maximum configuration:  
26 m horizontal cable plus 2 m patch cord at either end

### Structure

### Cables

G20 S/F (4x2x AWG 22/1)  
(Order no.: LKD 7KS8 0020 0000)

### Side A / side B

**MegaLine® Connect100** cable plug Cat. 7<sub>A</sub>

### Standards

- ▶ ISO/IEC 11801
- ▶ EN 50173-1
- ▶ IEEE 802.3bt 4PPoE

Article	Length*	Order no.
<b>MegaLine® Connect100</b> trunk cable	10.0 m	LKD9AA617820000
	15.0 m	LKD9AA618200000
	20.0 m	LKD9AA617830000
	30.0 m	LKD9AA618210000
	40.0 m	LKD9AA618220000
	50.0 m	LKD9AA618230000

\* standard lengths, other lengths and types of cable (also pre-assembled at one end) on request



# MegaLine® Connect100

Pre-assembled trunk & pre-assembled CP cables

On request, with documented acceptance measurement as a PDF file.

## MegaLine® Connect100 CP cable, Cat.7<sub>A</sub>

### Description

The Consolidation Point cable is based on a G20 S/F flex data cable – assembled at both ends with a **MegaLine® Connect100** socket and a TERA®/ARJ45® plug.

Thanks to its high-quality components in combination with a CP link (> 10 m), the preassembled cable meets the requirements for Class F<sub>A</sub> permanent links according to ISO/IEC 11801 Amendment 2 for 10 Gigabit Ethernet.

### Structure

Cables	G20 S/F flex (4x2x AWG26/7) (Order no.: LKD 7KS8 0013 0000)
Side A	<b>MegaLine® Connect100</b> Cat. 7 <sub>A</sub> cable plugs
Side B	TERA®plug/ARJ45® plug

### Standards

- ▶ ISO/IEC 11801
- ▶ EN 50173-1
- ▶ IEEE 802.3bt 4PPoE

Article	Length*	Order no.
<b>MegaLine®</b> Connect100 CP cable (TERA)	5.0 m	LKD9A0619450000
	10.0 m	LKD9A0619460000
	15.0 m	LKD9A0619470000
	20.0 m	LKD9A0619480000
	25.0 m	LKD9A0619490000

\* Standard lengths / additional lengths on request

# MegaLine® PATCH CORD TERA®



## MegaLine® Patch TERA®

### Description

Patch cords and connection cables are fitted with TERA® or RJ45 plugs as required (the RJ45 plug has a moulded boot). The appropriate cable type for the application is used for assembly. Cable type F10-120 S/F flex used is designed for a bandwidth of up to 1000 MHz with 4-pair assignment.

### Standards

- ▶ ISO/IEC 11801 / EN 50173
- ▶ RoHS compliant with 2011/65/EU

◆ 10BASE-T / 100BASE-T2	TERA® 2-pair to RJ45
◆ Token ring	TERA® 2-pair to RJ45
◆ ISDN	TERA® 2-pair to RJ45
◆ Telephone services	TERA® 1-pair to RJ45
◆ Telephone services	TERA® 1-pair to RJ11
◆ Any	TERA® 4-pair to RJ45
◆ 2-pair connecting line	TERA® to TERA®
◆ 4-pair connecting line	TERA® to TERA®

### Applications





### Wiring

Applications	10BASE-T / 100BASE-T2	Token ring	ISDN	Telephony
Patch cables				
Wiring	TERA® 2-pair to RJ45	TERA® 2-pair to RJ45	TERA® 2-pair to RJ45	TERA® 1-pair to RJ45

Length	Article	Order no.			Article	Order no.
m		10BASE-T / 100BASE-T2	Token ring	ISDN		Telephony
1.0	MegaLine® patch cord TERA® 2-pair to RJ45 (F10-120 S/F flex)	LKD9AA400000000	LKD9AA400060000	LKD9AA400120000	MegaLine® patch cord TERA® 1-pair to RJ45 (326 flex)	LKD9A0400220000
2.0		LKD9AA400010000	LKD9AA400070000	LKD9AA400130000		LKD9A0400230000
3.0		LKD9AA400020000	LKD9AA400080000	LKD9AA400140000		LKD9A0400240000
5.0		LKD9AA400030000	LKD9AA400090000	LKD9AA400150000		LKD9A0400250000

TERA® is a registered trademark of Siemon

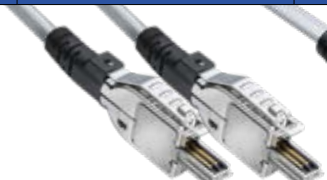

Applications	Telephony	any	2-pair connecting line	4-pair connecting line
Patch cables				
Wiring	TERA® 1-pair to RJ11	TERA® 4-pair to RJ45	TERA® to TERA®	TERA® to TERA®

Length	Article	Order no.	Article	Article	Order no.		
m		Telephony	any		2-pair connecting line 4-pair connecting line		
1.0	MegaLine® Patch TERA® 1-pair to RJ11 (326 flex)	LKD9A0400170000	MegaLine® patch cord TERA® 4-pair to RJ45 (F10-120 S/F flex)	LKD9AA400390000	MegaLine® patch cord TERA® to TERA® (F10-120 S/F flex)	LKD9AA400260000	LKD9AA400320000
2.0		LKD9A0400180000		LKD9AA400400000		LKD9AA400270000	LKD9AA400330000
3.0		LKD9A0400190000		LKD9AA400410000		LKD9AA400280000	LKD9AA400340000
5.0		LKD9A0400450000		LKD9AA400420000		LKD9AA400290000	LKD9AA400350000

TERA® is a registered trademark of Siemon

# MegaLine® TRUNK CABLES

Pre-assembled multi-cable with **MegaLine® Connect45 Pro** or **MegaLine® Connect100**

On request, with documented acceptance measurement as a PDF file.



## MegaLine® Connect45 Pro Multi-Trunk, n-fold MegaLine® Connect100 Multi-Trunk, n-fold

### Description

The trunk cable is based on a multi-data cable (F6-90 S/F; F10-115 S/F; G20 S/F) – assembled on both sides with **MegaLine® Connect45 Pro** sockets and/or **MegaLine® Connect100** cable plugs.

Thanks to its high-quality components, the pre-assembled cable meets the requirements for permanent links of the relevant class in accordance with ISO/IEC 11801 and EN 50173.

### Structure

- ▶ Cable Multi-data cable (F6-90 S/F; F10-115 S/F; G20 S/F)
- ▶ Jack modules **MegaLine® Connect100**
- ▶ Side A / side B Various **MegaLine® Connect100** sockets, see table
- ▶ Whip length 0.35 m

### Standards

- ▶ ISO/IEC 11801
- ▶ EN 50173-1

Cable type	Cable length Max.	Cat. 6 <sub>A</sub>		Cat. 7 <sub>A</sub>			Cat.8.2			
		Socket A	Socket B	Socket A	Socket B	Socket A	Socket B	Socket A	Socket B	
		MC45 Pro MC100 RJ45		MC100 ARJ MC100 TERA® MC100 Interface			MC100 ARJ MC100 TERA® MC100 Interface			
Horizontal multi *	4-fold F6-90 S/F	90 m	◆	◆						
	6-fold F6-90 S/F	35 m	◆	◆						
	4-fold F10-115 S/F	35 m	◆	◆	25 m	◆	◆			
	6-fold F10-115 S/F	35 m	◆	◆	25 m	◆	◆			
	4-fold G20 S/F	35 m	◆	◆	25 m	◆	◆	26 m	◆	◆
	6-fold G20 S/F	35 m	◆	◆	25 m	◆	◆	26 m	◆	◆

\* More available on request ◆

# MegaLine® TRUNK CABLES

Pre-assembled single cable with MegaLine® Connect45 Pro jack modules Cat. 6<sub>A</sub>

On request, with documented acceptance measurement as a PDF file.

Jack module Cat. 6<sub>A</sub>  
Aqua marking

**MegaLine® Connect45 Pro Trunk Cat. 6<sub>A</sub> module**  
**MegaLine® Connect100 Trunk Cat. 6<sub>A</sub> module**

## Description

The trunk cable is based on a F6-90 S/F data cable preassembled at both ends with **MegaLine® Connect45 Pro** sockets.

Thanks to its high-quality components, the preassembled cable fulfils the requirements for permanent links (> 1 m, **Cat. 6<sub>A</sub> modules**) of Class E<sub>A</sub> according to ISO/IEC 11801 and EN 50173 for 10 Gigabit Ethernet.

The length specifications relate to the 2-connector model.

## Structure

- ▶ Cables various types, see table
- ▶ Socket modules **MegaLine® Connect100**  
**MegaLine® Connect45 Pro**
  - ▶ Keystone, ELine
- ▶ Side A / side B Various sockets, see table

## Standards

- ▶ ISO/IEC 11801
- ▶ EN 50173-1
- ▶ IEC60603-7-51 (Cat. 6<sub>A</sub>)

Cable type	Cable length Standard Max.	Cat. 6 <sub>A</sub>		
		Socket A	Socket B	
		MC45 Pro MC100 RJ45		
horizontal installation	E5-60 U/F	90 m	◆	◆
	E5-70 F/F	90 m	◆	◆
	E5-70 S/F	90 m	◆	◆
	F6-90 S/F	90 m	◆	◆
	ML Pro 1000	90 m	◆	◆
	F10-115 S/F	90 m	◆	◆
	ML Pro 1200	90 m	◆	◆
	F10-125 S/F	90 m	◆	◆
	ML Pro 1300	90 m	◆	◆
	F10-130 S/F	90 m	◆	◆
	ML Pro 1500	90 m	◆	◆
	G12-150	90 m	◆	◆
	G20	90 m	◆	◆

\* More available on request ◆

# MegaLine® CONSOLIDATION POINT Connect45 Pro

Pre-assembled multi-cable with **MegaLine® Connect45 Pro** or **MegaLine® Connect100**

On request, with documented acceptance measurement as a PDF file.



## MegaLine® Connect45 Pro Multi-CP Flex cable MegaLine® Connect100 Multi-CP cable Flex

### Description

The trunk cable is based on a multi-data cable (F6-90 S/F flex; F10-120 S/F flex; G20 S/F flex) – pre-assembled on both sides with **MegaLine® Connect45 Pro** sockets and/or **MegaLine® Connect100** flex cable plugs.

Thanks to its high-quality components, the pre-assembled cable meets the requirements for permanent links of the relevant class in accordance with ISO/IEC 11801 and EN 50173.

### Structure

- ▶ Cable Multi-data cable (F6-90 S/F flex; F10-120 S/F flex; G20 S/F flex)
- ▶ Socket modules **MegaLine® Connect100**  
**MegaLine® Connect45 Pro**  
▶ Keystone, ELine
- ▶ Side A / side B see table
- ▶ Whip length 0.35 m

### Standards

- ▶ ISO/IEC 11801
- ▶ EN 50173-1

Cable type	Cable length Max.	Cat. 6 <sub>A</sub>		Cat. 7 <sub>A</sub>			Cat. 8.2			
		Connector SL	Socket	Connector	Socket B		Connector	Socket B		
		RJ45	MC45 Pro MC100 RJ45	TERA® 4P	MC100 TERA® MC100 Interface	TERA® 4P	MC100 TERA® MC100 Interface			
Flex multi *	4-fold F6-90 S/F	50 m	◆	◆						
	6-fold F6-90 S/F	35 m	◆	◆						
	4-fold F10-120 S/F	35 m	◆	◆	25 m	◆	◆			
	6-fold F10-115 S/F	35 m	◆	◆	25 m	◆	◆			
	4-fold G20 S/F	35 m	◆	◆	25 m	◆	◆	26 m	◆	◆
	6-fold G20 S/F	35 m	◆	◆	25 m	◆	◆	26 m	◆	◆

\* More available on request ◆

# MegaLine® CONSOLIDATION POINT Connect45 Pro

Pre-assembled single cable with MegaLine® Connect45 Pro jack modules Cat. 6<sub>A</sub>



Jack module Cat. 6<sub>A</sub>  
Keystone format

RJ-45 plug Cat. 6<sub>A</sub>

On request, with documented acceptance measurement as a PDF file.

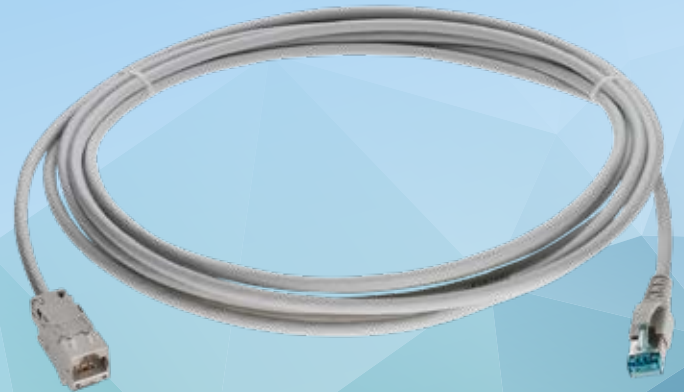

**MegaLine® Connect45 Pro CP flex cable**  
**MegaLine® Connect100 CP cable Flex**

## Description

The consolidation point cable is based on an F10-120 S/F flex data cable assembled on both sides with a MegaLine® Connect45 Pro socket and an RJ45 SmartLock plug.

Thanks to its high-quality components in combination with a CP link (> 10 m), the pre-assembled cable meets the requirements for permanent links of Class E<sub>x</sub> in accordance with ISO/IEC 11801 Amendment 2 for 10 Gigabit Ethernet.

## Standards

- ▶ ISO/IEC 11801
- ▶ EN 50173-1
- ▶ IEC60603-7-51

## Structure

- ▶ **Cables** various types, see table
- ▶ **Socket modules** MegaLine® Connect100  
MegaLine® Connect45 Pro  
▶ Keystone, ELine
- ▶ **Side A / side B** Various sockets, see table  
RJ45 plug (SmartLock Cat. 6<sub>A</sub>)

	Cable type	Cable length Max.	Cat. 6 <sub>A</sub>	
			Connector SL	
			RJ45	Socket MC45 Pro MC100 RJ45
flex	E5-70 S/F flex	50 m	◆	◆
	F6-90 S/F flex	50 m	◆	◆
	F10-120 S/F flex	50 m	◆	◆
	G20 flex	50 m	◆	◆

\* More available on request ◆

# VarioLine® SYSTEM PERIPHERY IN COPPER AND FO



## VarioLine® MODULAR, ROBUST AND EASY TO INSTALL

VarioLine® is perfectly coordinated with the modular KERPEN DATACOM connection systems **MegaLine®** Connect100 and **MegaLine®** Connect45 Pro. What is more, all systems can be integrated with Keystone dimensions and commonly used FO cable couplings.



## VarioLine® system periphery in copper and FO

Page

**VarioLine® CP Consolidation Point range**

147



Consolidation Point housing

with DIN rail clip

148

**VarioLine® UF – underfloor systems**

151



System overview

152



Support plates for underfloor systems

- for installation of wall boxes
- for installation of adapter plates

154

155



Adapter plates for underfloor systems

for installation in  
**VarioLine®** UF support plates

156



Support plates for underfloor systems

for the installation of adapter plates

158



Blind cover

for **VarioLine®** UF support plates

159



Office application



Data centre application



## VarioLine® CP – CONSOLIDATION POINT RANGE

for copper and FO connectivity

The Consolidation Point range is an efficient and low-cost solution for highly flexible horizontal, data centre or industrial cabling.

Consolidation Points (CP) are highly flexible office cabling solutions (EN 50173-2) suitable for rapidly changing office environments. They act as collection points between floor distributors (FD) and telecommunication outlets (TO).

The CP can be installed in a double floor, false ceiling, column or duct. From there, flexible lines (CP cables) lead to the data sockets at the workstations.

CP cabling links permanently installed cables to modular or mobile office systems, such as partition walls or office furniture in which the TO is already installed. In industrial cabling, this is referred to as an intermediate distributor (ID) – a connection between the floor distributor (FD) and the telecommunication outlet (TO) that allows temporary machine cabling to be created, for example (EN 50173-3).

In data centres, CPs provide an additional marshalling option (EN 50173-5) as local distribution points (LDP) between the zone distributor (ZD) and the equipment outlet (EO).

The robust VarioLine® Consolidation Points are made of galvanised sheet metal and are available in various sizes.

Various module panels are available for VarioLine® CP housings:

- ▶ MegaLine® Connect100
- ▶ MegaLine® Connect45 Pro
- ▶ GigaLine® SC Duplex

On request we can expand our product range quickly and flexibly to include additional module panels – for modular use with copper and fibre optic systems.

### VarioLine® CP benefits:

- ▶ The patch end is protected by means of a pivoting cover with a brush strip (optional).
- ▶ Support for incoming cables and patch cords can be provided by means of cable ties.
- ▶ The housings can be earthed if necessary.
- ▶ The DIN rail clip included with the housing extends the range of possible applications to include DIN rails.



# VarioLine® CONSOLIDATION POINT HOUSING

with DIN rail clip

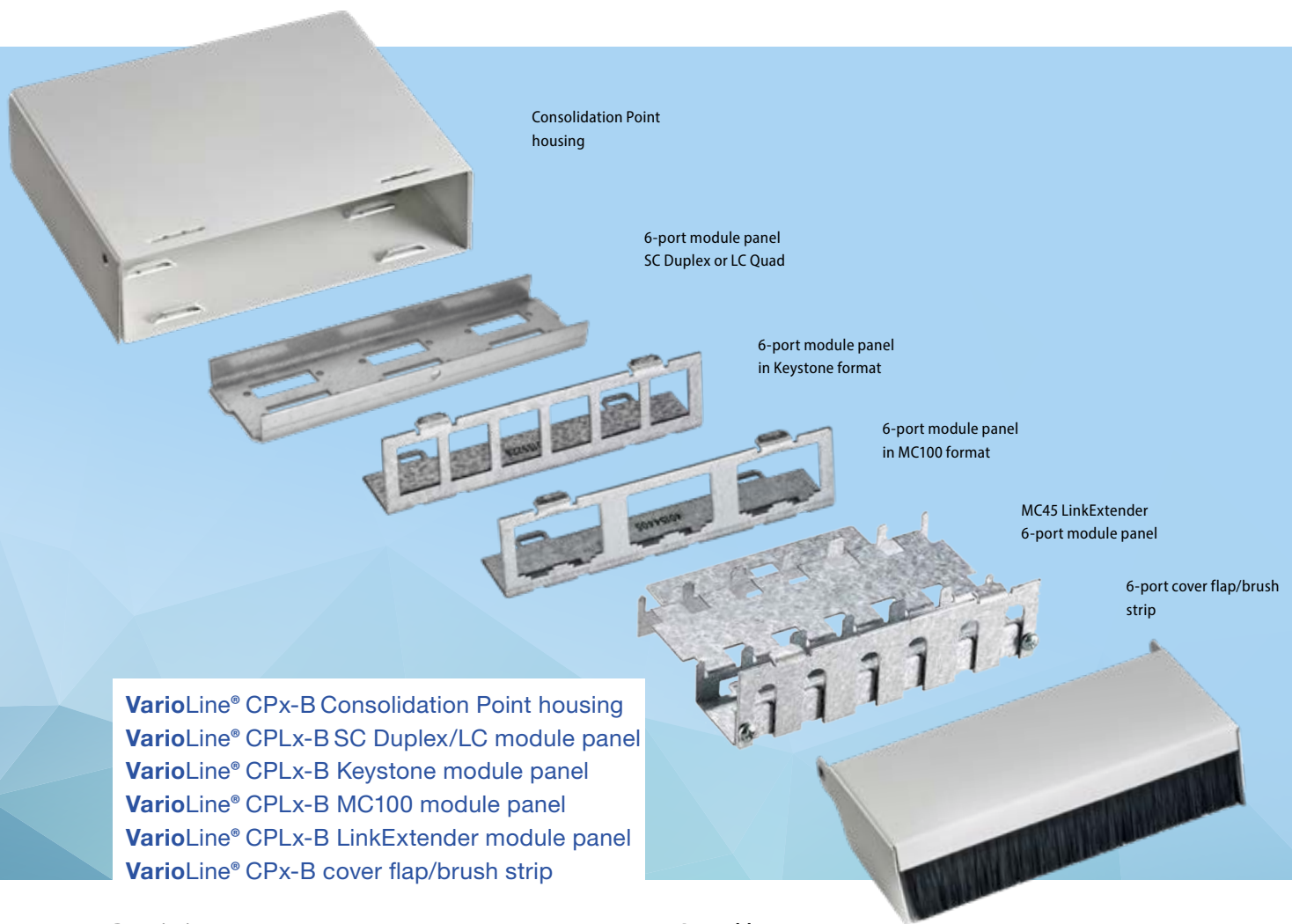

**VarioLine® CPx-B Consolidation Point housing**  
**VarioLine® CPLx-B SC Duplex/LC module panel**  
**VarioLine® CPLx-B Keystone module panel**  
**VarioLine® CPLx-B MC100 module panel**  
**VarioLine® CPLx-B LinkExtender module panel**  
**VarioLine® CPx-B cover flap/brush strip**

## Description

For installation in a double floor or false ceiling. CP housing with strain relief using cable ties (not included). Can be equipped with **MegaLine® Connect45 Pro** or **MegaLine® Connect100** modules.

A cover flap with integrated brush strip can optionally be used on the patch side.







- ▶ Modular (exchangeable module panel)
- ▶ Optionally available with 6, 12 or 24 ports
- ▶ Rugged housing made of galvanised sheet metal
- ▶ Free of hazardous substances

## Assembly

- ▶ The CP housing is attached by a DIN rail clip (compatible clip included)
- ▶ Alternative attachment using screws or impact dowels (not included)
- ▶ Module panel is attached by snapping into housing
- ▶ Modules are attached by **snapping into the module panel**



Assembly example:  
housing with mounted  
rail clip

housing	SC Duplex / LC	Keystone for MegaLine® Connect45 Pro (Keystone) jack modules	MC100 for MegaLine® jack modules MegaLine® Connect100	LinkExtender for MegaLine® Connect45 LinkExtender	Cover flap/ brush strip
					

Ports	Order no.					
6	LKD9ZE610070000	LKD9ZE610410000	LKD9ZE610640000	LKD9ZE610140000	LKD9ZE610920000	LKD9ZE610080000
12	LKD9ZE610740000	-	LKD9ZE610670000	LKD9ZE610170000	LKD9ZE610930000	LKD9ZE610730000
24	LKD9ZE610750000	-	LKD9ZE610680000	LKD9ZE610180000	LKD9ZE610940000	LKD9ZE610760000



## VarioLine® UF – UNDERFLOOR SYSTEMS

Support plate solution – modular & universal

**VarioLine® UF underfloor systems (floor outlet solutions) are an efficient and low-cost solution for completing copper and FO systems.**

They provide a high degree of flexibility in offices. Workplaces can be connected to the energy and IT grid without the usual cable tangle. The modular and universal support plate solutions are available for all commonly available underfloor systems (e.g. Ackermann or Electraplan).

The support plate replaces the device carrier, so it provides maximum space for cable feed. The slanted inlets and outlets ensure safe cable routing even under very low raised floors.

The use of adapter plates allows low-cost, efficient installation of the entire range of KERPEN DATACOM connection technology in both copper and FO versions.



Example of an underfloor solution made by KERPEN DATACOM in an OBO Bettermann floor outlet

# VarioLine® UF – UNDERFLOOR SYSTEMS

## System overview



**VarioLine®**  
Sockets

**MegaLine®**  
Connect100  
4K7A

**MegaLine®**  
Connect100  
Interface

**MegaLine®**  
Connect100  
RJ45



**VarioLine®**  
Adapter plate

**VarioLine®** UF AP3-VK  
For max. 3 **MegaLine®** Connect100 modules  
Page 156



**MegaLine®**  
Connect45 Pro Plus ELine  
Page 124



**VarioLine®** UF AP3-MC45E  
for max. 3 **MegaLine®** Connect45-Module  
and Pro Plus ELine  
Page 157



**MegaLine®**  
Connect45 Pro Plus  
Page 124



**VarioLine®** UF AP3-MC45K  
for max. 3 **MegaLine®** Connect45 Pro  
modules (in Keystone format)  
Page 156





**VarioLine®**  
Support plate

**VarioLine® UF TA2**  
for Ackermann  
GES 2, 4, 6, R4, R7  
Page 155

**VarioLine® UF TA3**  
for Ackermann  
GES 9, R7, R9  
Page 155

**VarioLine® UF TEK3**  
for Electraplan KDR series  
(old design)  
Page 155

**VarioLine® UF TEV3**  
for Electraplan  
VQ12, VR12, VR10  
Page 155

# VarioLine® SUPPORT PLATES FOR UNDERFLOOR SYSTEMS

for the installation of wall boxes



Fig. 1  
VarioLine® UF TOA2-2 support plate  
for Ackermann GES 2, 4, 6, R4, R7



Fig. 2  
VarioLine® UF TOA3-2 support plate  
for Ackermann GES 9, R7, R9

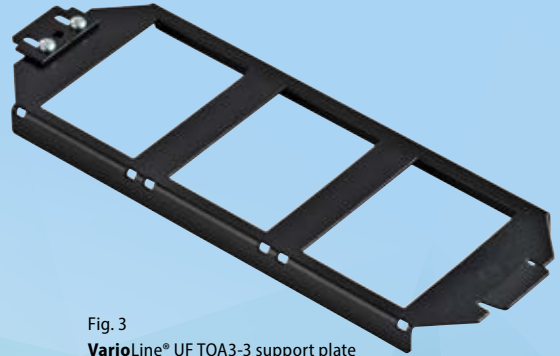

Fig. 3  
VarioLine® UF TOA3-3 support plate  
for Ackermann GES 9, R7, R9

## VarioLine® UF TOA2-2 / UF TOA3-2

### Description

**UF TOA2-2** ▶ for installation of max. 2 wall outlets with a 50 mm x 50 mm central plate and side fastening or one wall outlet with a circumferential ring.

**UF TOA3-2** ▶ for installation of max. 2 wall outlets with a 50 mm x 50 mm central plate and side fastening or 2 wall outlets with a circumferential ring.

For installation in Ackermann device inserts.

### housing

Support plate powder-coated sheet metal, 1.5 mm  
Colour Jet black, RAL 9005

## VarioLine® UF TOA3-3

### Description

For installing max. 3 wall outlets with a 50 mm x 50 mm central plate and side fastening or 2 wall outlets with a circumferential ring.

For installation in Ackermann device inserts.

### housing

Support plate powder-coated sheet metal, 1.5 mm  
Colour Jet black, RAL 9005

Fig.	Article	Order no.
1	VarioLine® UF TOA2-2 (1 pc.)	LKD9ZE600140000
2	VarioLine® UF TOA3-2 (1 pc.)	LKD9ZE600120000

Fig.	Article	Order no.
3	VarioLine® UF TOA3-3 (1 pc.)	LKD9ZE600130000

# VarioLine® SUPPORT PLATES FOR UNDERFLOOR SYSTEMS

for the installation of adapter plates

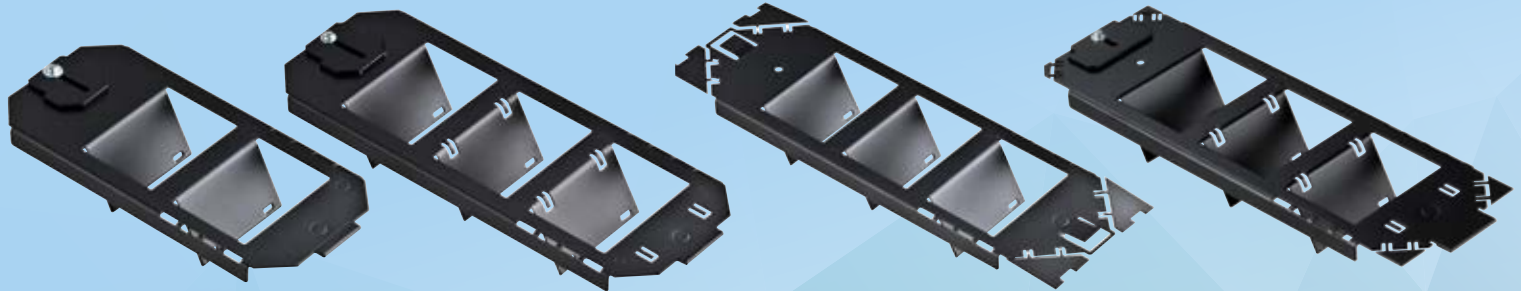

Fig. 1  
**VarioLine® UF TA2** support plate  
for Ackermann  
GES 2, 4, 6, R4, R7

Fig. 2  
**VarioLine® UF TA3** support plate  
for Ackermann  
GES 9, R7, R9

Fig. 1  
**VarioLine® UF TEK3** support plate  
for Electraplan KDR series  
(old design)

Fig. 2  
**VarioLine® UF TEV3** support plate  
for Electraplan  
VQ12, VR12, VR10

## VarioLine® UF TA2/UF TA3

### Description

For installation of max. 2 or 3 adapter plates.  
For installation in Ackermann device inserts.

### Compatibility

UF TA2	Ackermann GES 2, 4, 6, R4, R7
UF TA3	Ackermann GES 9, R7, R9

### housing

Support plate	powder-coated sheet metal, 1.5 mm
Colour	Jet black, RAL 9005

### Accessories (optional)

Cable strain relief **VarioLine® UF K1** / **VarioLine® UF K2**  
adjustable cable strain relief for up to 9 single cables

## VarioLine® UF TEK3/UF TEV3

### Description

For installation of max. 3 adapter plates.  
For installation in Electraplan device outlets.

### Compatibility

UF TEK3	Electraplan KDR series (old design)
UF TEV3	Electraplan VQ12, VR12, VR10

### housing

Support plate	powder-coated sheet metal, 1.5 mm
Colour	Jet black, RAL 9005

### Accessories (optional)

Cable strain relief **VarioLine® UF K1** / **VarioLine® UF K2**  
adjustable cable strain relief for up to 9 single cables

Fig.	Article	Order no.
1	<b>VarioLine® UF TA2</b> (1 pc.)	LKD9ZE600010000
2	<b>VarioLine® UF TA3</b> (1 pc.)	LKD9ZE600020000

Fig.	Article	Order no.
1	<b>VarioLine® UF TEK3</b> (1 pc.)	LKD9ZE600080000
2	<b>VarioLine® UF TEV3</b> (1 pc.)	LKD9ZE600420000

# VarioLine® ADAPTER PLATES FOR UNDERFLOOR SYSTEMS

for installation in VarioLine® UF support plates

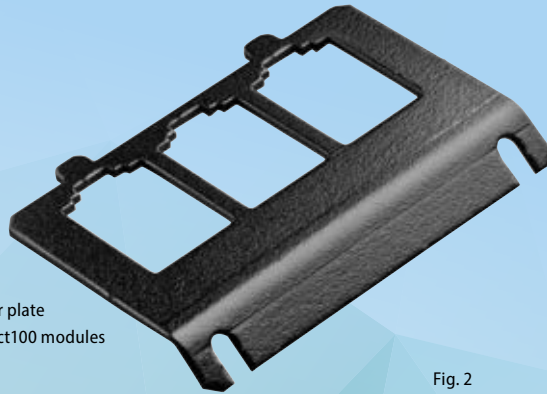

Fig. 1  
**VarioLine® UF AP3 VK** adapter plate  
 For max. 3 **MegaLine® Connect100** modules

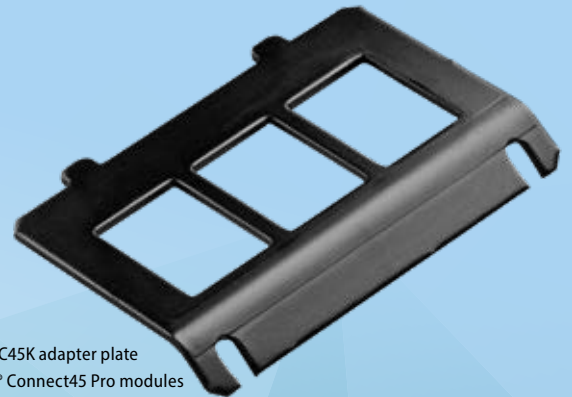

Fig. 2  
**VarioLine® UF AP3 MC45K** adapter plate  
 for max. 3 **MegaLine® Connect45 Pro** modules  
 (Keystone)

**VarioLine® UF AP3-VK**  
**VarioLine® UF AP3-MC45**

**Description**

Adapter plate for installation in **VarioLine®** UF support plates.  
 For installation of max. 3 modules.

- ▶ With self-adhesive labelling strips for labelling as required
- ▶ 2 nut and washer assemblies incl.

**Compatibility**

- UF AP3 VK ▶ for max. 3 **MegaLine®**
- UF AP3 MC45K ▶ for max. 3 **MegaLine® Connect45 Pro** modules (Keystone)

**Structure**

- Adapter plate sheet metal, 1.5 mm
- Surface Zn – black, conductive

Matching Sockets	MegaLine® Connect100 Interface	MegaLine® Connect100 4K7A	MegaLine® Connect100 RJ45	MegaLine® Connect45 Pro (Keystone)
VarioLine® UF AP3 VK				
VarioLine® UF AP3 MC45K				

Fig.	Article	Order no.
1	VarioLine® UF AP3-VK (1 pc.)	LKD9A4601180000
2	VarioLine® UF AP3-MC45 (1 pc.)	LKD9ZE600440000

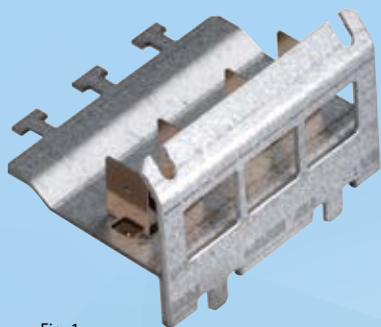

Fig. 1  
VarioLine® UF AP3-MC45E adapter plate  
for max. 3 MC45 modules (in ELine format)



Fig. 2  
VarioLine® UF AP4-SCD adapter plate  
for max. 4 SC Duplex couplings



Fig. 3  
VarioLine® UF AP4-LCD adapter plate  
for max. 4 LC Duplex couplings

## VarioLine® UF AP3-MC45E

### Description

Adapter plate for installation in **VarioLine®** UF support plates.  
For installation of max. 3 MC45 modules (in ELine format).

- ▶ With earthing or ground connection
- ▶ With self-adhesive labelling strips for labelling as required
- ▶ 2 nut and washer assemblies incl.

### Structure

Adapter plate sheet metal, 1.5 mm  
Surface Aluminium-zinc

## VarioLine® UF AP4-SCD/UF AP4-LCD

### Description

Adapter plate for installation in **VarioLine®** UF support plates.  
For installation of max. 4 SC or LC Duplex couplings.

- ▶ With self-adhesive labelling strips for labelling as required
- ▶ 2 nut and washer assemblies incl.

### Compatibility

UF AP4-SCD for max. 4 SC Duplex or SC Duplex/  
ST couplings  
UF AP4-LCD for max. 4 LC Duplex, SC Simplex or  
E-2000 couplings

### Structure

Adapter plate sheet metal, 1.5 mm  
Surface ZN – black, conductive

Matching sockets	MegaLine® Connect45 Pro Plus ELine	GigaLine® SC Duplex	GigaLine® LC Quad	GigaLine® SC Simplex	GigaLine® LC Duplex	GigaLine® E-2000
VarioLine® UF AP3-MC45E						
VarioLine® UF AP4-SCD						
VarioLine® UF AP4-LCD						

Fig.	Article	Order no.
1	VarioLine® UF AP3-MC45E (1 pc.)	LKD9ZE601060000

Fig.	Article	Order no.
2	VarioLine® UF AP4-SCD (1 pc.)	LKD9FZZ00780000
3	VarioLine® UF AP4-LCD (1 pc.)	LKD9FZZ00790000

# VarioLine® SUPPORT PLATES FOR UNDERFLOOR SYSTEMS

for the installation of adapter plates



Fig. 1  
**VarioLine®** UF TA2 3VK support plate  
for Ackermann  
GES 2, 4, 6, R4, R7

Fig. 2  
**VarioLine®** UF TA3 3VK support plate  
for Ackermann  
GES 9, R7, R9

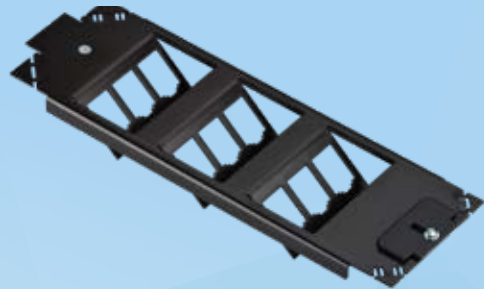

**VarioLine®** UF TEV3 3VK support plate  
for Electraplan  
VQ12, VR12, VR10

## VarioLine® UF TA2 3VK/UF TA3 3VK

### Description

Support plate with max. 2 or 3 integrated adapter plates.  
For installation in Ackermann device outlets.

### Compatibility

UF TA2 3VK	Ackermann GES 2, 4, 6, R4, R7
UF TA3 3VK	Ackermann GES 9, R7, R9

### housing

Support plate	powder-coated sheet metal, 1.5 mm
Colour	Jet black, RAL 9005

### Accessories (optional)

Cable strain relief **VarioLine®** UF K1 / **VarioLine®** UF K2  
adjustable cable strain relief for up to 9 single cables

## VarioLine® UF TEK3 3VK/UF TEV3 3VK

### Description

Support plate with max. 3 integrated adapter plates.  
For installation in Ackermann device outlets.

### Compatibility

UF TEK3 3VK	Electraplan KDR series (old design)
UF TEV3 3VK	Electraplan VQ12, VR12, VR10

### housing

Support plate	powder-coated sheet metal, 1.5 mm
Colour	Jet black, RAL 9005

### Accessories (optional)

Cable strain relief **VarioLine®** UF K1 / **VarioLine®** UF K2  
adjustable cable strain relief for up to 9 single cables



Matching Sockets	MegaLine® Connect100 Interface	MegaLine® Connect100 4K7A	MegaLine® Connect100 8C7A	MegaLine® Connect100 RJ45
<b>VarioLine®</b> UF TA2 3VK / UF TA3 3VK				
<b>VarioLine®</b> UF TEK3 3VK / UF TEV3 3VK				

Fig.	Article	Order no.
1	<b>VarioLine®</b> UF TA2 3VK (1 pc.)	LKD9ZE600460000
2	<b>VarioLine®</b> UF TA3 3VK (1 pc.)	LKD9ZE600450000

Fig.	Article	Order no.
1	<b>VarioLine®</b> UF TEK3 3VK (1 pc.)	LKD9ZE600480000
2	<b>VarioLine®</b> UF TEV3 3VK (1 pc.)	LKD9ZE600470000

## VarioLine® CABLE STRAIN RELIEF for VarioLine® UF support plates

## VarioLine® BLIND COVER for VarioLine® UF support plates

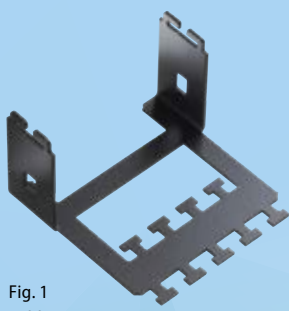

Fig. 1  
Cable tray  
UF support plates

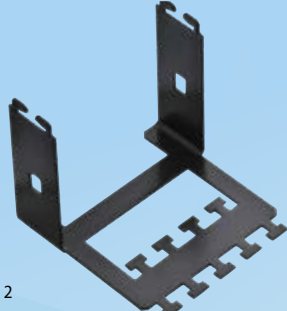

Fig. 2  
Cable strain relief  
UF support plates



Fig. 3  
Blind cover  
UF support plates

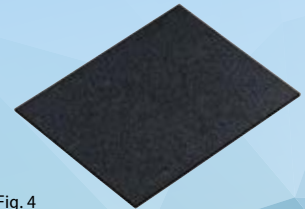

Fig. 4  
Blind cover  
UF support plates  
for wall box inserts

### VarioLine® UF K1 VarioLine® UF K2

#### Description

Cable strain relief for attachment to VarioLine® UF support plates for fastening nine individual cables.

#### Compatibility

UF K1	For <b>VarioLine®</b> UF support plates
UF K	For <b>VarioLine®</b> UF support plates

#### housing

Cable tray	powder-coated sheet metal, 1.5 mm
Colour	Jet black, RAL 9005
Elevation	45 / 65 mm (UF K1 / UF K2)

### VarioLine® UF BP-T VarioLine® UF BP-TO

#### Description

Blind cover to close an unused opening in the **VarioLine®** UF support plate (incl. 2 combination nuts).

#### Compatibility

UF BP-T	For <b>VarioLine®</b> UF support plates
UF BP-TO	For <b>VarioLine®</b> UF support plates

#### housing

Blind cover	powder-coated sheet metal, 1.5 mm
Colour	Jet black, RAL 9005

Fig.	Article	Order no.
1	VarioLine® UF K1 (1 pc.)	LKD9ZE600030000
2	VarioLine® UF K2 (1 pc.)	LKD9ZE600040000

Fig.	Article	Order no.
3	VarioLine® UF BP-T (1 pc.)	LKD9ZE600050000
4	VarioLine® UF BP-TO (1 pc.)	LKD9ZE600150000

# ACCEPTANCE MEASUREMENTS

for **MegaLine®** cabling systems

The acceptance measurements of **MegaLine®** cabling systems for transmission paths (channels) or installation paths (permanent links) is carried out in accordance with the requirements of ISO/IEC 11801 or EN 50173. Further standards related to conducting acceptance measurements: DIN EN 50346 and DIN EN 61935.





## ACCEPTANCE MEASUREMENT FOR CLASS E<sub>A</sub>

MegaLine® Connect100/  
MegaLine® Connect45 Pro

For acceptance measurements according to Class E<sub>Av</sub>, set the measuring device to a measuring bandwidth of 500 MHz.

For details, refer to the instructions on setting the measuring device. Information can be found at:

- ▶ [www.flukenetworks.com](http://www.flukenetworks.com)
- ▶ [www.itnetworks.softing.com](http://www.itnetworks.softing.com)
- ▶ [www.trend-networks.com](http://www.trend-networks.com)

Ensure the measuring adapters are connected to the measuring device and firmly engaged. Take the corresponding measuring cable and ensure it is firmly plugged in. If synchronisation is required, this is then carried out according to the instructions for the device.

## ACCEPTANCE MEASUREMENT FOR CLASS F<sub>A</sub>

MegaLine® Connect100

For acceptance measurements according to Class F<sub>Av</sub>, set the measuring device to a measuring bandwidth of 1000 MHz.

For details, refer to the instructions on setting the measuring device.

- ▶ [www.flukenetworks.com](http://www.flukenetworks.com)
- ▶ [www.itnetworks.softing.com](http://www.itnetworks.softing.com)
- ▶ [www.trend-networks.com](http://www.trend-networks.com)

Ensure the measuring adapters are connected to the measuring device and firmly engaged. Take hold of the corresponding measuring cable and ensure that it is firmly plugged in. Carry out the field zeroing process on the device according to the operating instructions.

### STANDARD ACCEPTANCE: PERMANENT LINK

System	 <p>MegaLine® Connect45      MegaLine® Connect100 RJ45</p>
Approved measuring devices	 <p>LanTEK III-1000 (available from Trend Networks)</p> <p>Fluke DSX 8000 (available from Fluke Networks)</p> <p>Softing WireXpert 4500 (available from Softing IT Networks)</p>

### STANDARD ACCEPTANCE: PERMANENT LINK

System	 <p>MegaLine® Connect100 4K7A jack module</p>
Approved measuring devices	 <p>LanTEK III-1000 (available from Trend Networks)</p> <p>Fluke DSX 8000 (available from Fluke Networks)</p> <p>Softing WireXpert 4500 (available from Softing IT Networks)</p>

## ALIEN CROSSTALK



Alien crosstalk describes the undesirable mutual electrical influence between parallel links in the installation duct and in the vicinity of the patch panels. In contrast to NEXT and attenuation, disturbance through alien crosstalk cannot be compensated for electronically.

Alien crosstalk has become extremely important from a technical point of view. ISO/IEC 11801 (generic cabling for customer premises) takes this fact into account by including corresponding specifications for the new transmission classes E<sub>A</sub> (500 MHz) and F<sub>A</sub> (1000 MHz).

**MegaLine®** S/FTP cabling systems meet the requirements for alien crosstalk with a high degree of reliability. External influences from adjacent channels are prevented and suppressed simultaneously via the double shielding of the S/FTP cables and the modular shielding of the connectivity.

Alien crosstalk is attenuated by >100 dB (a factor of 100,000).

These characteristics are design-specific and do not change in the installation environment. IEEE 802.3an considers shielded cabling systems to be the preferred solution.

Frequency MHz	Minimum PS ANEXT dB	
	Class E <sub>A</sub> , F	Class F <sub>A</sub>
1	67.0	67.0
100	60.0	67.0
250	54.0	67.0
500	49.5	64.5
1000	N/A	60.0

Requirements of PS Alien Next and PS AACR-F  
at selected frequencies

Frequency MHz	Minimum PS AACR-F dB	
	Class E <sub>A</sub> , F	Class F <sub>A</sub>
1	67.0	67.0
100	37.0	52.0
250	29.0	44.0
500	23.0	38.0
1000	N/A	32.0

Requirements of PS Alien Next and PS AACR-F  
at selected frequencies

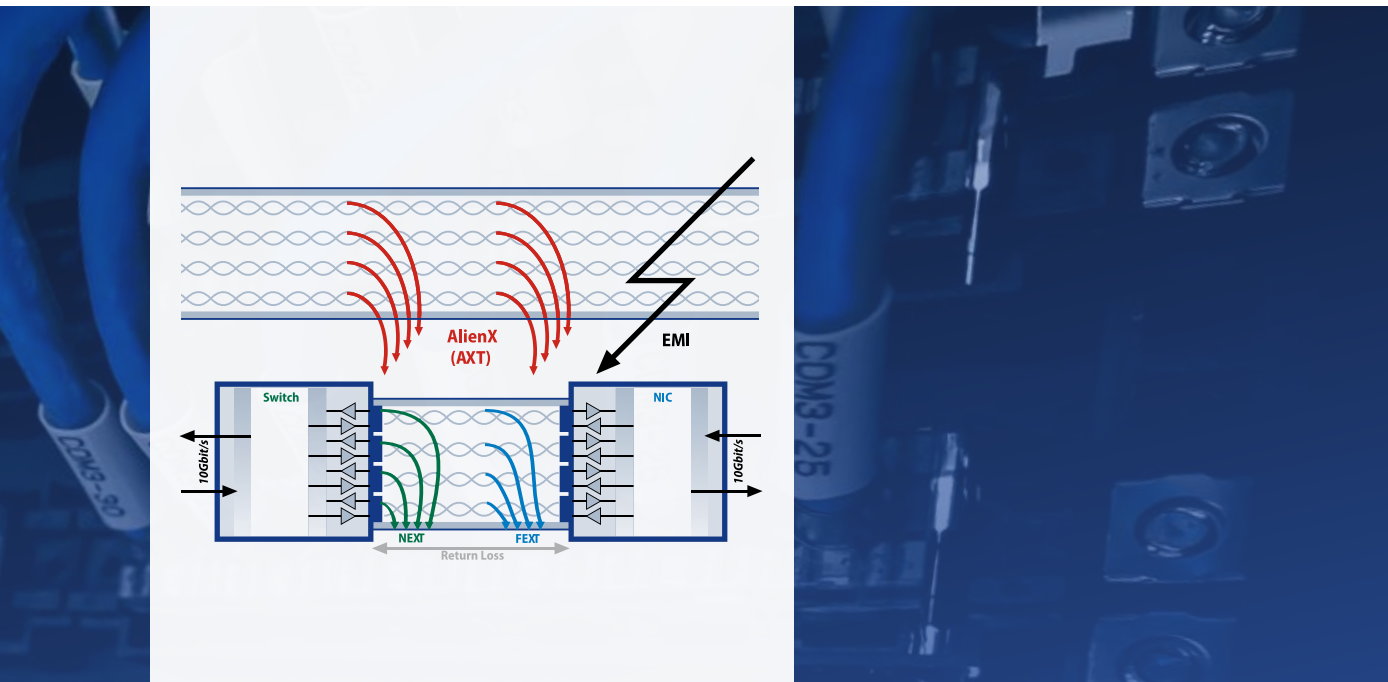

### Coupling attenuation

Coupling attenuation evaluates the overall EMC behaviour of a cable or individual link. The coupling attenuation consists of the shielding attenuation and the asymmetrical attenuation taken together and defines the degree of reduction of electrical influences on a signal path.

If the coupling attenuation for Class E<sub>A</sub> and F transmission links is 10.0 dB better than in the table below and for Class F<sub>A</sub> transmission links 25.0 dB better than in the table below, the values for the parameters Power Sum Alien NEXT (PS ANEXT) and Power Sum Alien ACR-F (PS AACR-F) are complied with automatically as a result of the design, making it unnecessary to demonstrate them explicitly.

Class	Frequency MHz	Min. dB dB
D, E, E <sub>A</sub> , F, F <sub>A</sub>	$30 \leq f \leq \text{Note 2}$	$80 - 20 \lg(f)$

Note 1: Round down calculated values greater than 40 dB to 40 dB.

Note 2: Coupling attenuation is measured up to 1000 MHz but the limit is determined by the upper frequency of the Class being tested.

Requirements for coupling attenuation for cabling Classes D to F<sub>A</sub>

Coupling attenuation for Class E<sub>A</sub> and F:

> 90 – 20 log(f), > 50 dB up to 100 MHz

Coupling attenuation for Class F<sub>A</sub>:

> 105 – 20 log(f), > 65 dB up to 100 MHz

Due to the coupling mechanisms, this relationship only applies to shielded and not to unshielded cables.

### MegaLine® measurement results

All modularly or individually shielded **MegaLine®** cabling systems have met the extended requirements for coupling attenuation according to Class E<sub>A</sub>. The comprehensive assessments were concluded with the award of the relevant certifications.

### MegaLine® measurement results

All modularly or individually shielded **MegaLine®** cabling systems have met the extended requirements for coupling attenuation according to Class E<sub>A</sub>. MC100 4K7 even meets Class F<sub>A</sub> requirements. The comprehensive assessments were concluded with the award of the relevant certifications.

# MegaLine® @HOME

## ONE NETWORK

## NO LIMITS



# MegaLine® @HOME – ALL DATA IN ONE

Go for the convenient home option – one data network for an entire lifetime

In the near future, we will be able to manage and operate our entire home environment from just a few screens, such as TVs, smartphones or tablets. This will expand the potential uses of applications such as watching TV, gaming, streaming and storage and simplify how we control electrical appliances, lighting, HVAC and security systems.

Data will be available in the blink of an eye from any wall socket with rates of up to 10 Gbit/s. Films, images and music will download in the blink of an eye and surfing the internet will become a truly new experience.

KERPEN DATACOM has the perfect neutral data network with **MegaLine®@home**. Just like an electricity supply, any data socket will be able to power any application. With the right modules installed, it will be possible to control building automation systems and hard drive recorders while on the go. Integrating the domestic wireless LAN network is also extremely straightforward.

Convenience, entertainment, building automation and security are high-priority factors for **MegaLine®@home** and it can even make room for your own personal creativity.

## Basic components

### MegaLine® Slim 600

The **MegaLine® Slim 600** data cable forms the backbone of the network, transmitting all data to the wall outlets at a rate of 10 Gbit/s. This means the network is perfectly prepared for a long service life. Related products even offer the option of providing the power supply for end devices and setting up an outdoor connection.

### MegaLine® Connect

The sockets and plugs of the **MegaLine® Connect** series are the interfaces between the cables and wall outlets. They ensure that all devices can make the most of these high data rates.

### MegaLine® Patch

**MegaLine® Patch** patch cords and connection cables distribute all applications to the connections and connect devices to the wall outlets. This is the final link in the transmission chain.

## Convenience components

### Components:

Active devices are required to turn the KERPEN DATACOM base network into a real multimedia network.

Specialist retailers offer an extensive range of suitable products to meet all requirements.

- ▶ Telephone system and wireless LAN router
- ▶ Switch
- ▶ IP video cameras
- ▶ BUS system
- ▶ Repeater
- ▶ Satellite system
- ▶ Sensors and actuators
- ▶ End devices
- ▶ Installation material

## CONVENIENCE FOR ALL

A data network is the basis for distributing all data within the household,

providing easy access to centrally stored data such as photos, films and music and making it easier than ever to control heat, lighting and alarm systems.

Connection to the internet is no problem either of course, so everyone to get the full fun out of surfing and gaming for example, or streaming films and photographs.



### COMMUNICATION

Fast Internet and phone calls are increasingly merging into one. The **MegaLine®@home** data network is ready and waiting for grid expansion and already offers data rates of 10 Gbit/s.

- ▶ **Voice over IP**
- ▶ **Telephone, fax, scanner, smartphone, tablet**
- ▶ **PC, laptop**



### ENTERTAINMENT

Watching TV, gaming, surfing, listening to music, looking at photographs or streaming. Everything is available all the time, wherever you want. The neutral network structures even allow the various applications to be exchanged. **MegaLine®@home** interconnects all devices, turning the TV into a slide projector or a hi-fi system, for example.

- ▶ **TV, TV over IP, photographs**
- ▶ **Gaming consoles**
- ▶ **Music, radio**
- ▶ **PC, surfing, tablets**
- ▶ **Power over Ethernet (PoE)**



### BUILDING AUTOMATION

Forgotten to switch off the lights? Is the cooker still on? No worries! The interface to the in-house BUS system lets you conveniently control all your devices even when you're out and about.

- ▶ **Heat, light, shades**
- ▶ **Household appliances**
- ▶ **Presence and smoke detectors**
- ▶ **Renewable energies, garden irrigation**



### SECURITY

Outdoor surveillance, presence detectors or alarm systems – **MegaLine®@home** makes it all possible and provides a connection to let you check your home at any time.

- ▶ **Network security**
- ▶ **Alarm systems**
- ▶ **Surveillance cameras**
- ▶ **Admission control and access security**

# BUILDING TECHNOLOGY AND MULTIMEDIA

## Planning example

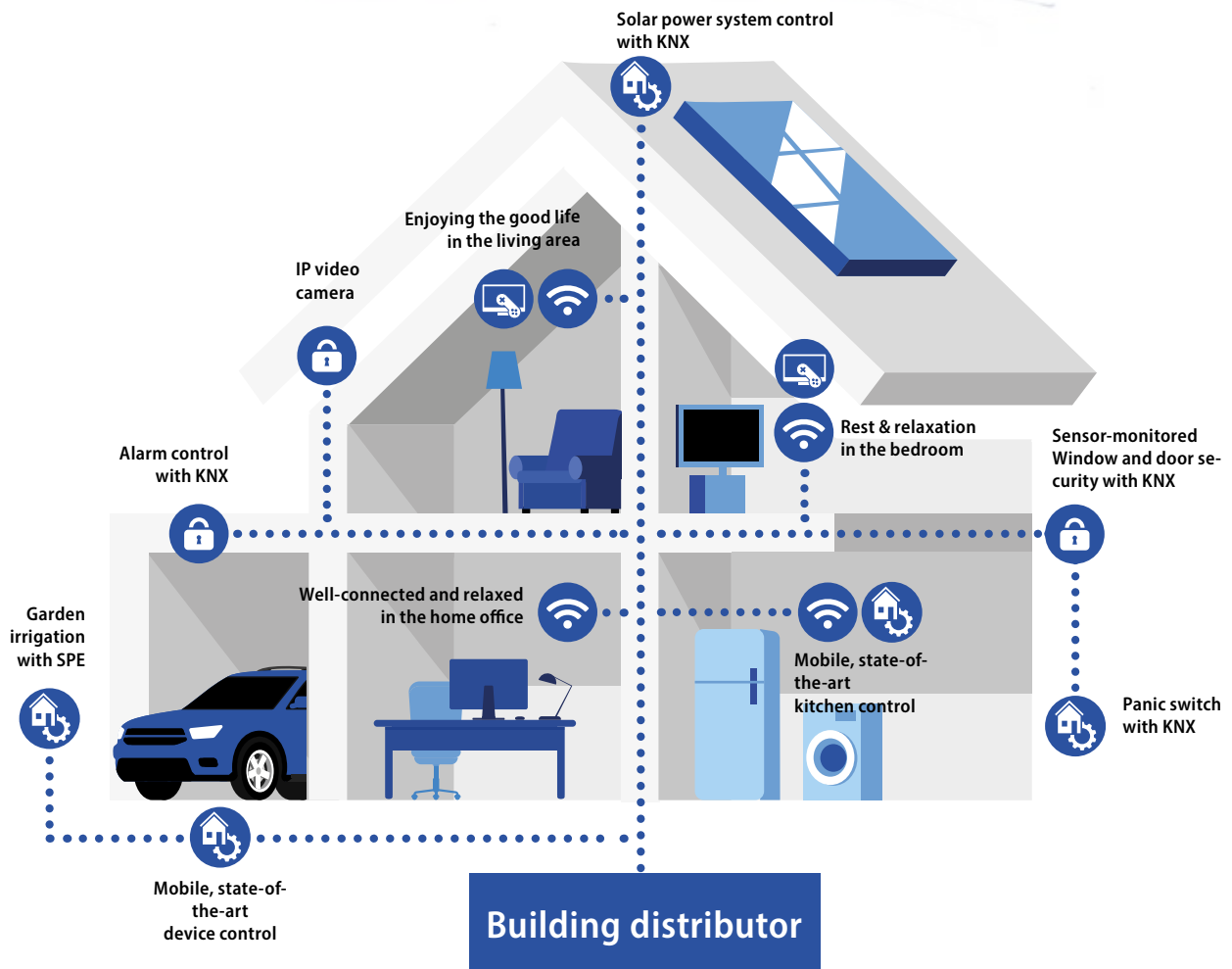

# MegaLine® @HOME – AT A GLANCE

Product range

## WALL OUTLET



2-fold wall socket

## CONNECTORS



Jack module (Keystone format)  
Cat. 6A ISO/IEC

LinkExtender Class EA

RJ-45 plug

## INSTALLATION COMPONENTS



Keystone 24-port panel

## CABLING

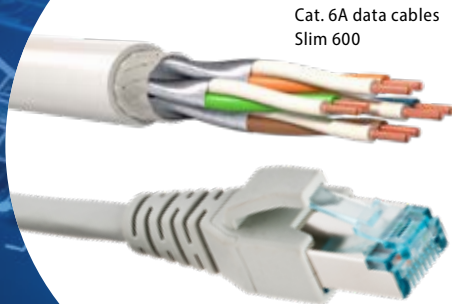

Cat. 6A data cables  
Slim 600

6AEA-RJ45 patch cord  
RJ45-RJ45, Cat. 6A

Product	Order no.
MegaLine® Slim 600, 350 m	LKD7KS703040035
MegaLine® Slim 600, 100 m	LKD7KS703040010
MegaLine® Connect45 Pro Plus Jack module (Keystone format) Cat. 6 <sub>A</sub> ISO/IEC	LKD9ZQ010040024
MegaLine® Connect45 LinkExtender Class E <sub>A</sub> shielded without cable plug	LKD9A5000100000
MegaLine® Connect45 RJ-45 plug, field-configurable	LKD9A5000200000
Keystone wall socket, 2-fold with design capability	LKD9ZQ010110000
Keystone 24-port panel Grey ◆ Black ◆	LKD9A5012000000 LKD9A5012010000

Product	Order no.	
Stripping tool for PiMF	LKD9AW160430000	
MegaLine® Patch 6AEA-RJ45 patch cord RJ45-RJ45, Cat. 6 <sub>A</sub> shielded, 4-pair	◆◆ 1.0 m	LKD9A0230210000
	◆◆ 3.0 m	LKD9AA230250000
	◆◆ 1.0 m	LKD9A0230310000
	◆◆ 3.0 m	LKD9A0230350000
	◆◆ 1.0 m	LKD9A0230410000
	◆◆ 3.0 m	LKD9A0230450000
	◆◆ 1.0 m	LKD9A0230510000
	◆◆ 3.0 m	LKD9A0230550000
◆◆ 1.0 m	LKD9A0230610000	
◆◆ 3.0 m	LKD9A0230650000	

\* other common lengths and colours available on request



# KERPEN DATACOM & PARTNERS

Industry-wide competence from a single source



**Specialist electricians, specialist wholesalers and KERPEN DATACOM – an unbeatable combination.**

**The combination of specialist installers, retailers and manufacturers gives you a multitude of possibilities in terms of product diversity, fastest availability and the highest level of expertise at every level.**

KERPEN DATACOM's **MegaLine®@home** forms the basis of your home network. You benefit not only from premium products but also from our experience gathered over more than 20 years of producing network system technology of the very highest quality. The individual products are manufactured in Germany to top industrial and environmental standards and exceed all current data technology requirements.

## SPECIALIST EXPERTISE

### KERPEN DATACOM

- ▶ German manufacturer of professional data networks
- ▶ Greatest expertise in data transmission products
- ▶ Premium product quality for future-oriented security

### Specialist wholesaler

- ▶ Expertise and advice on active components and solution strategies
- ▶ All-in-one domestic solution from power to light and data
- ▶ Swiftest availability

### Specialist electricians

- ▶ Trained personnel for on-site data network setup
- ▶ Custom solutions available
- ▶ Peace of mind due to superlative product quality and verified compatibility

# OFFICE APPLICATIONS



# GENERIC CABLING IN OFFICE BUILDINGS

The complete cable system – from distribution equipment to workstation

## Structure of a generic communication cable system ISO/IEC 11801 and DIN EN 50173-1/2

CD	Campus distributor
BD	Building distributor
FD	Floor distributor
CP	Consolidation Point
TO	Telecommunications outlet
TE	Terminal equipment

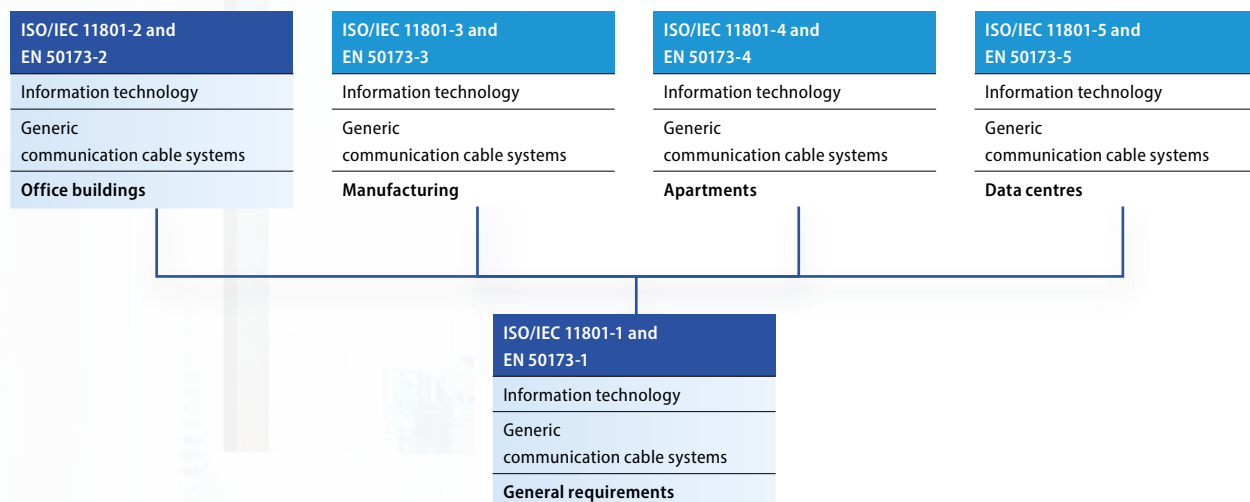
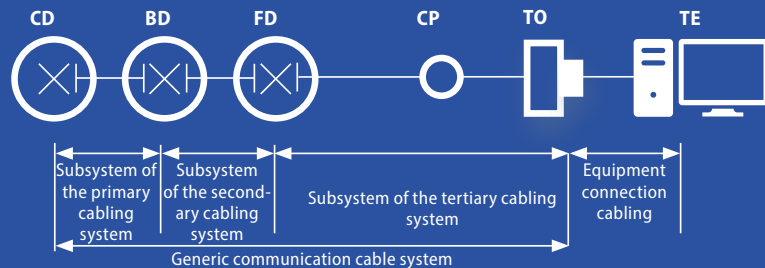

**A company's future success is now heavily dependent on having a reliable and modern data processing infrastructure.**

The rapid development of data transfer rates and the wide variety of applications require a network infrastructure that provides maximum that is still capable of fulfilling the requirements that will apply 10 years down the road.

High-quality generic IT networks form the backbone of the business in research & development, banks, insurance companies, universities, hospitals, hotels, airports and many other sectors, providing smooth operation and financial success.

The smart use of fibre optic technology in the backbone and copper technology all the way to the user not only enables cost-effective networking of standard resources, such as PCs and printers, but can also be extended to include IP telephony and multimedia applications. Other applications, such as Power-over-Ethernet (PoE), support the powering of devices such as web cameras, wireless LAN access points, IP phones and laptops via the copper data cabling.

These structured, application-neutral communication cable systems are standardised internationally and in Europe by ISO/IEC 11801 and DIN EN 50173.

# INDUSTRY APPLICATIONS

# GENERIC CABLING FOR INDUSTRIAL ENVIRONMENTS

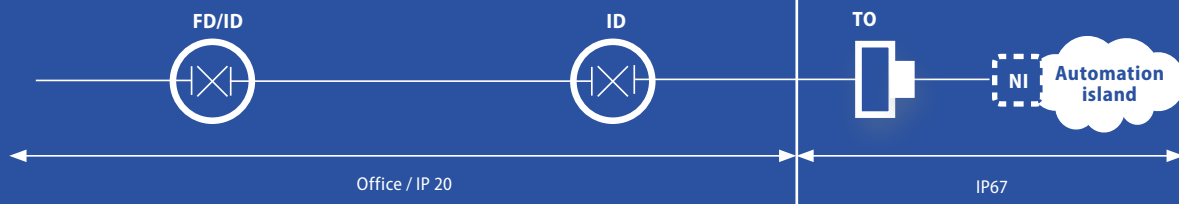

## Structure of a generic communications cable system in industrial locations ISO / IEC 24702 and EN 50173-3

### Office / IP 20



### IP67



ISO/IEC 11801 and  
EN 50173-2

Information technology

Generic  
communication cable systems

Office buildings

ISO/IEC 24702 and  
EN 50173-3

Information technology

Generic  
communication cable systems

Manufacturing

ISO/IEC 15018 and  
EN 50173-4

Information technology

Generic  
communication cable systems

Apartments

ISO/IEC 24764 and  
EN 50173-5

Information technology

Generic  
communication cable systems

Data centres

ISO/IEC 11801 and  
EN 50173-1

Information technology

Generic  
communication cable systems

General requirements

# INDUSTRIAL IT CABLING

Uniform IT platforms are increasingly used to connect different worlds



The boundaries between office and industrial cabling are becoming increasingly indistinct. The need for sales departments to receive current production data or to engage in short-term planning of production processes requires a uniform group-wide IT platform.

Manufacturers of automation and control equipment demand consistent, future-proofed international standards, while users are looking for secure investments. Ever more applications in production processes are implemented via Ethernet, reducing maintenance and operating costs. Existing standards and applications, such as PROFINET, will still need support in the years to come.

This results in a requirement for a clear separation between "application" and "network". This can only be achieved by using a uniform platform – generic communication cabling – both in offices and in production areas. The requirement has been standardised in the EN 50173-1, EN 50173-2, EN 50173-3 series of standards and in the international standards ISO/IEC 11801 and ISO/IEC 24702.

The consistent continuing use of generic cabling offers enormous advantages, such as:

- ▶ Reduction in the assortment of products
- ▶ Deployment and distribution of mass-produced products
- ▶ Standardisation of acceptance measurements
- ▶ Reduction in training costs
- ▶ Easy trouble-shooting
- ▶ Simplification of network operation, maintenance and documentation

It is frequently observed these days that the transmission requirements in industrial environments are less challenging than those in the office area. This fact can be exploited to cut costs without compromising long-term system readiness. As cable laying is expensive and a subsequent expansion of technical requirements would lead to unnecessary additional costs, we recommend selecting data cables that meet the highest standards (Category 7 or above).

Connection technology can be limited to the necessary minimum, however, if an intelligent adaptation to changes in circumstances is possible both in terms of pathway technologies and the structural and/or production-related environment.

# MICE CONCEPT

Classification of environmental conditions

# MICE CONCEPT

MICE	Requirement/level 1	Requirement/level 2	Requirement/level 3
M Mechanical	M <sub>1</sub>	M <sub>2</sub>	M <sub>3</sub>
I Ingress	I <sub>1</sub>	I <sub>2</sub>	I <sub>3</sub>
C Climatic/Chemical	C <sub>1</sub>	C <sub>2</sub>	C <sub>3</sub>
E Electromagnetic	E <sub>1</sub>	E <sub>2</sub>	E <sub>3</sub>

## The environmental factor

As well as electrical or optical transmission channels, the different conditions in office and industrial settings mean that environmental factors also play an important role.

These environmental conditions are described using four basic characteristics:

<b>Mechanical</b>	Mechanical properties
<b>Ingress</b>	Ingress protection properties
<b>Climatic/Chemical</b>	Climatic and chemical properties
<b>Electromagnetic</b>	Electromagnetic properties

The four MICE criteria are broken down into different parameters, each with three levels.

- ▶ **Office environment** M<sub>1</sub>/I<sub>1</sub>/C<sub>1</sub>/E<sub>1</sub>
- ▶ **Factory environment (light duty)** M<sub>2</sub>/I<sub>2</sub>/C<sub>2</sub>/E<sub>2</sub>
- ▶ **Machine environment (heavy duty)** M<sub>3</sub>/I<sub>3</sub>/C<sub>3</sub>/E<sub>3</sub>

The MICE classification can vary over the length of the transmission link. For example, mechanical loads are fairly low in office environments and the ingress of liquids or significant climatic and chemical loads are equally unlikely. On the other hand, conditions in buildings used for industrial purposes are tougher:

Mechanical loads as well as the risk of ingress of dust, dirt and liquids; high, quickly changing temperatures; solar radiation and corrosive substances can affect the components. Electromagnetic interference also influences the data communication.

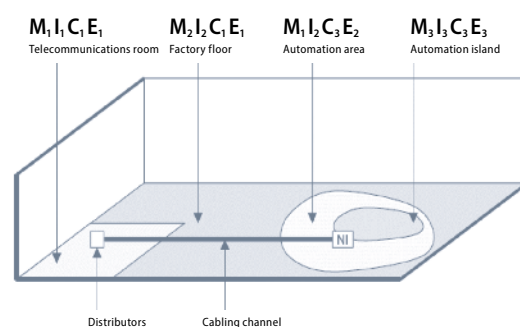

# DATA CENTRES APPLICATIONS



# GENERIC CABLING IN DATA CENTRES

## Structure of a generic communication cable system

ENI	External interface
MD	Main distributor
ZD	Zone distributor
LDP	Local distribution point (optional)
EO	Equipment outlet
EQP	Application-specific transmission equipment

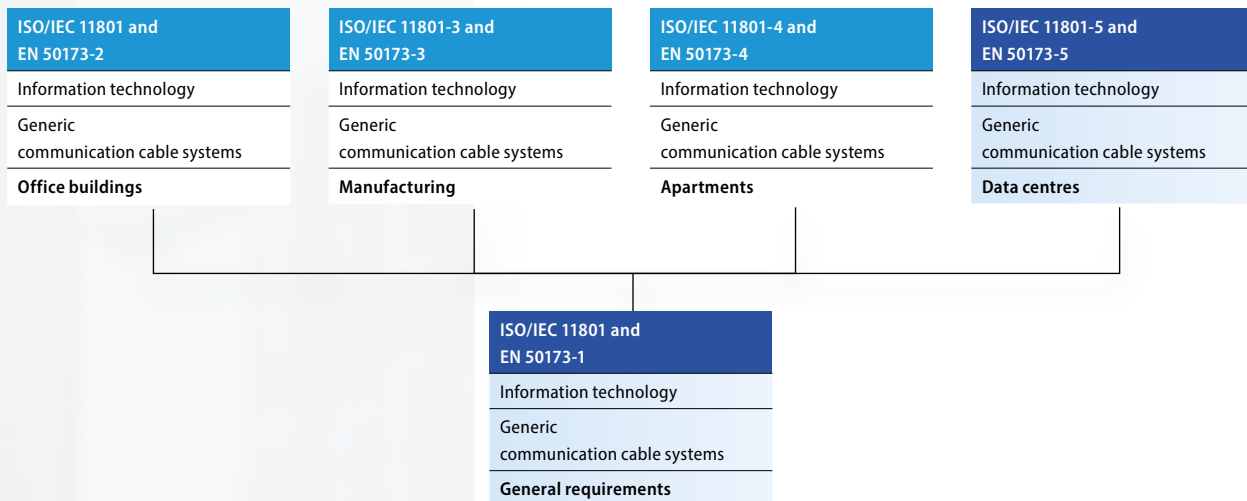
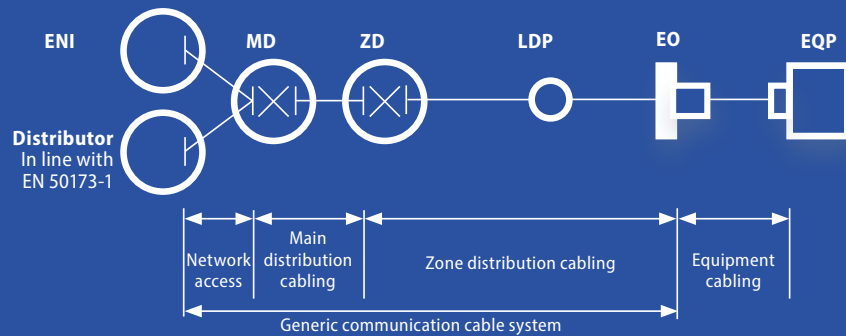

### Structure

The maximum extension is 2,000 metres. In data centres, the main distribution cabling is frequently designed using fibre optic technology. In smaller networks, the external network interface (ENI) is connected directly to the zone distributor (ZD). The standards describe various models for flexible and fixed connections in and between the subsystems.

According to ISO/IEC 11801-5, cabling of the main and zone distributors must meet at least the requirements of Class E<sub>A</sub> for copper technology and transmission classes OF-300, OF-500 and OF-2000 for FO technology.

### Standards

Generic communication cable systems are defined in the standards EN 50173-1 and ISO/IEC 11801.

In addition, specific requirements for data centres are defined in EN 50173-5 and ISO/IEC 11801-5.

The cabling used in data centres consists of three subsystems:

- ▶ **Network access cabling**
- ▶ **Main distribution cabling**
- ▶ **Zone distribution cabling**

# REQUIREMENTS AND SOLUTIONS

Fast – high-quality – cost-optimised



## Data centres

The data centre – the heart of a business – controls production and administrative processes. Failure here can have catastrophic consequences, so the data centre's availability must be guaranteed more or less round the clock. The cabling system is a key factor in terms of operational reliability.

### Performance requirements for modern data centres

- ▶ Max. availability with zero downtime ▶▶ Max. reliability
- ▶ Short installation times
- ▶ Maximum performance
- ▶ Minimal space requirement – high packing density
- ▶ Cost efficiency
- ▶ Environmental compatibility – Green IT

The various requirements for data centres cannot be considered separately. Optimising environmental performance can lead to a reduction in cost, for example. Investing in industrially pre-assembled components usually involves higher costs but enables installation and testing times to be reduced, thereby cutting the costs incurred by downtime.

### ▶ High quality

At KERPEN DATACOM, product quality is factory tested and performance and safety are already built-in.

### ▶ Minimised downtime

Both installation and commissioning are done in flash with no need for special tools or assembly skills. This keeps downtime to a minimum.

### ▶ Reduction in costs

Using **GigaLine® DClink** can cost up to 55% less than conventional modular systems with MPO connection technology

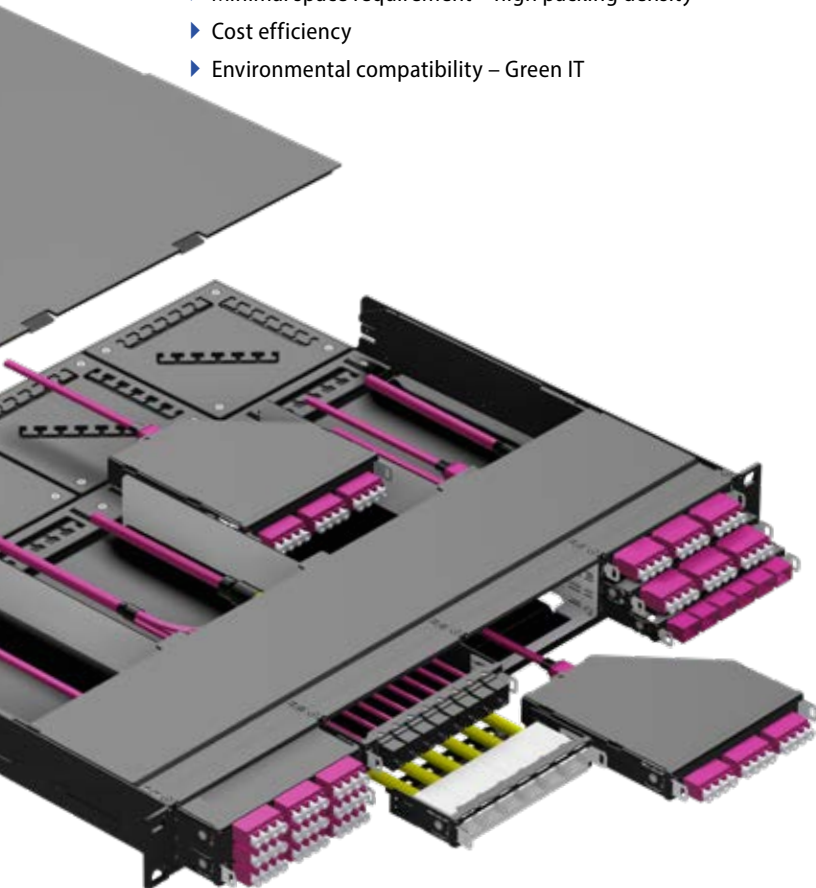

### Costs per link\*

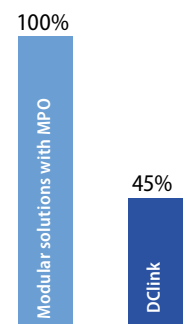

\* Example:  
Link length: 30 m,  
Fibres: 24 x OS2,  
Connector: LC Duplex

# BENEFITS

KERPEN DATACOM exceeds all requirements

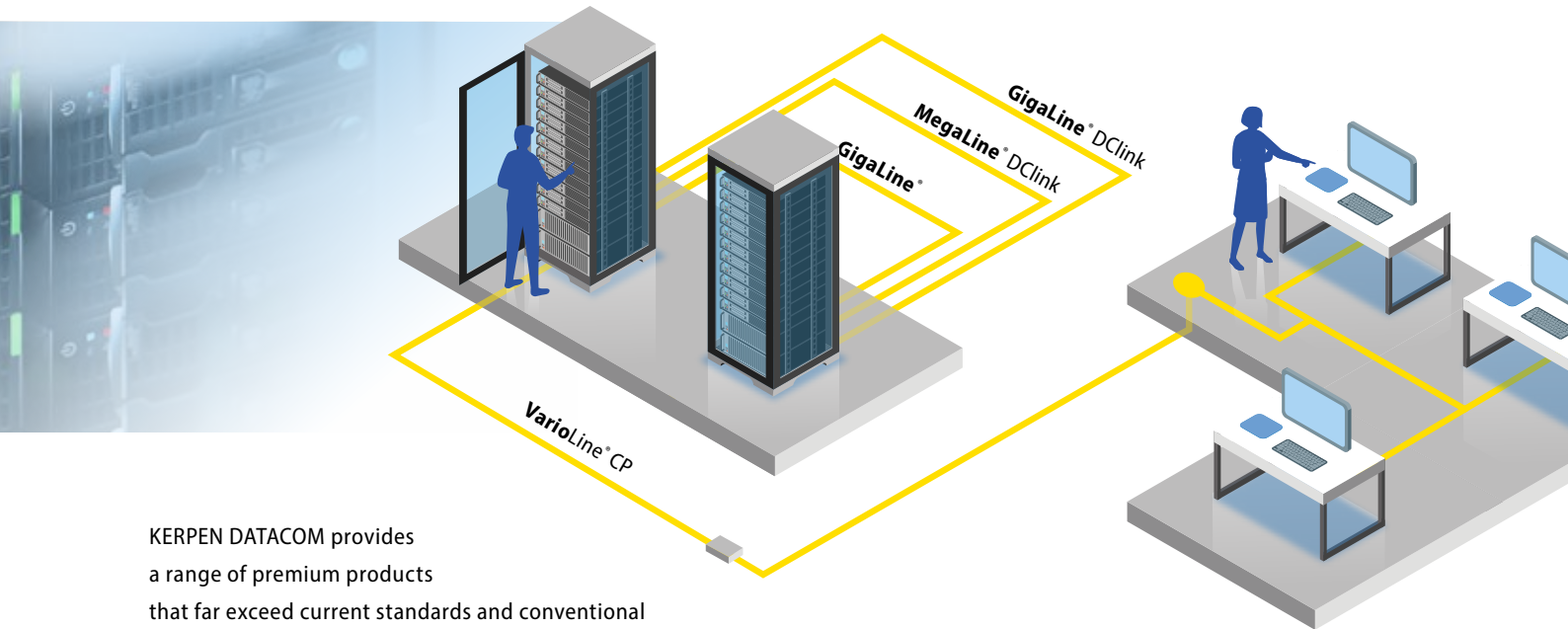

KERPEN DATACOM provides a range of premium products that far exceed current standards and conventional requirements for data centres:

- ▶ The **MegaLine®** Connect100 plugs and corresponding cables achieve performances up to Channel II (Cat. 8.2).
- ▶ Fibre optic cable systems constructed with KERPEN DATACOM cables have enormous reserves of attenuation and bandwidth

## Installation

Plug & play solutions for copper and FO applications comprise ready-to-use, preassembled links and the **VarioLine®** **DCLink** frame (19" 1 RU) to hold the **DCLink** modules. Once the link has been installed, the **DCLink** modules are simply inserted from the rear until they audibly click into place.

## DCLink system solutions

**DCLink** can be used to create FO, copper or mixed set-ups in different categories. This makes on-site assembly entirely superfluous. You can also remove the modules again very easily using a simple unlocking tool.

## Environmentally aware cabling

Environmentally friendly materials and production methods, recycling or ecologically viable recovery options and, last but not least, the reusability of products – these are the factors that guarantee maximum environmental compatibility. Our cables and components are free of hazardous substances.

## Optimising attenuation

The attenuation of **GigaLine®** **DCLink** is more than 70% lower than that of conventional modular systems with MPO connection technology.

## Attenuation per link\*

$I_L=1.4$  dB  
100%

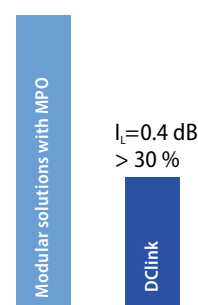

\* Example:  
Link length: 30 m,  
Fibres: 24 x OS2,  
Connector: LC Duplex

# INDEX

Introduction	
Contents	3
Company profile	4
Profile	5
Strong brands, great service	6
Technologies – investments in sustainable safety	7
Green technology	8
<b>MegaLine® copper data cables</b>	<b>10</b>
SPACE concept	12
SPACE – Security	13
SPACE – Performance	14
SPACE – Application	16
SPACE – Construction	17
SPACE – EMC	18
PoE (Power over Ethernet) on the advance	19
Benefits of PoE technology	20
Energy feed-in variants	21
Fire protection cable in accordance with the EU Construction Products Regulation	24
Safety in the event of a fire	25
Fire safety of cable systems	26
CE marking and declaration of performance	27
Fire classifications and proof of conformity	28
Overview of fire testing	29
Cable types with Euroclass B2 <sub>ca</sub> s1a d1 a1	31
On the safe side with KERPEN DATACOM	32
Data cable colour code according to CPR classes	33
Type codes	34
Cable types and materials	35
<b>MegaLine® G20 S/F</b>	<b>36</b>
<b>MegaLine® G20 S/F Mini</b>	<b>38</b>
<b>MegaLine® G12-150 S/F</b>	<b>40</b>
<b>MegaLine® F10-130 S/F</b>	<b>42</b>
<b>MegaLine® F10-125 S/F</b>	<b>44</b>
<b>MegaLine® F10-115 S/F</b>	<b>46</b>
<b>MegaLine® F6-90 S/F</b>	<b>48</b>
<b>MegaLine® F6-90 S/F Cl</b>	<b>50</b>
<b>MegaLine® E5-70 S/F</b>	<b>52</b>
<b>MegaLine® E5-70 F/F</b>	<b>54</b>
<b>MegaLine® E5-60 U/F</b>	<b>56</b>
<b>MegaLine® E2-45 U/F</b>	<b>58</b>
<b>MegaLine® E2-30 U/U</b>	<b>60</b>
<b>MegaLine® D1-20 SF/U</b>	<b>62</b>
<b>MegaLine® Pro 1500</b>	<b>64</b>
<b>MegaLine® Pro 1300</b>	<b>66</b>
<b>MegaLine® Pro 1000</b>	<b>68</b>
<b>MegaLine® G20 S/F Flex</b>	<b>70</b>
<b>MegaLine® F10-120 S/F Flex</b>	<b>72</b>
<b>MegaLine® F6-90 S/F Flex</b>	<b>74</b>
<b>MegaLine® D1-20 SF/U Flex</b>	<b>76</b>
<b>MegaLine® F10-130 S/F (L)2Y</b>	<b>78</b>
<b>MegaLine® F10-130 S/F QH</b>	<b>80</b>
<b>MegaLine® F10-130 S/F Vö</b>	<b>82</b>
<b>MegaLine® F6-90 S/F Vö</b>	<b>84</b>
<b>MegaLine® F10-115 S/F V</b>	<b>86</b>
<b>MegaLine® F6-90 S/F 2Y</b>	<b>88</b>
<b>MegaLine® D1-20 SF/U 2Y</b>	<b>90</b>
<b>MegaLine® F10-120 S/F 11Y Flex</b>	<b>92</b>
<b>MegaLine® F6-90 S/F 11Y Flex</b>	<b>94</b>
<b>MegaLine® D1-20 S/U 11Y Superflex</b>	<b>96</b>
<b>MegaLine® SPE AWG 26/7</b>	<b>98</b>
<b>MegaLine® SPE AWG 22/7</b>	<b>100</b>
<b>MegaLine® Slim 600</b>	<b>102</b>
<b>MegaLine® Connect100</b>	<b>104</b>
<b>Copper connection technology</b>	<b>104</b>
Ready for 40 Gbit/s	106
40 GBASE-T over copper	108
System overview	110
Cable plugs	112
Jack modules	113
Interface	114
Wall outlets	115
Patch panel 19"	116
DIN rail housing	116
Accessories & cable assembly tools	117
<b>MegaLine® Connect45 Pro Plus</b>	<b>118</b>
<b>MegaLine® Connect45 Pro</b>	<b>118</b>
<b>MegaLine® Connect45 Pro ELine</b>	<b>118</b>
<b>Copper connection technology</b>	<b>118</b>
<b>MegaLine® Connect45 Pro</b>	<b>120</b>
Installation options	121
System overview	122
Connect45 Pro Plus jack modules	124
Connect45 Pro jack modules	125
Patch panels 19" in Keystone format	126
Patch panels 19" in ELine format	126
DIN rail adapter for Keystone jack modules	127
Wall outlets for Keystone jack modules	127
<b>MegaLine® copper patch cords/trunk cables</b>	<b>128</b>
RJ45/RJ45 patch cord Cat. 5/100 MHz	130
RJ45/RJ45 patch cord Cat. 6/250 MHz	131
RJ45/RJ45 patch cord Cat. 6/250 MHz	132
RJ45/RJ45 patch cord Cat. 6 <sub>a</sub> /500 MHz	133
Industrial patch cords RJ45/RJ45 Cat. 5/100 MHz	134
Industrial patch cords RJ45/RJ45 Cat. 6/250 MHz	135
Connect 100	136
Connect 100	137
Patch cord TERA®	138
Trunk cables	140
Trunk cables	141
Consolidation Point cables	142
Consolidation Point cables	143
<b>VarioLine®</b>	<b>144</b>
<b>System periphery in copper and fibre</b>	<b>144</b>
Consolidation Point range	147
Consolidation Point housing	148
Underfloor systems	151
System overview	152
Support plates for underfloor systems for installing wall boxes	154
Support plates for underfloor systems for installing adapter plates	155
Adapter plates for underfloor systems	156
Support plates for underfloor systems	158
Blind cover	159
<b>MegaLine® acceptance measurements</b>	<b>160</b>
Class E <sub>x</sub> acceptance measurements	161
Class F <sub>x</sub> acceptance measurements	161
Alien crosstalk	162
<b>MegaLine® @home</b>	<b>164</b>
<b>One network – no limits</b>	<b>164</b>
<b>MegaLine®@home – all data in one</b>	<b>165</b>
Convenience for all	166
Building technology and multimedia Planning example	167
Product range	168
KERPEN DATACOM & Partners	169
<b>Office applications</b>	<b>170</b>
Generic cabling in office buildings	171
<b>Industrial applications</b>	<b>172</b>
Generic cabling in the industrial environment	173
Industrial IT cabling	174
MICE concept	175
<b>Data centre applications</b>	<b>176</b>
Generic cabling in data centres	177
Requirements and solutions	178
Benefits	179

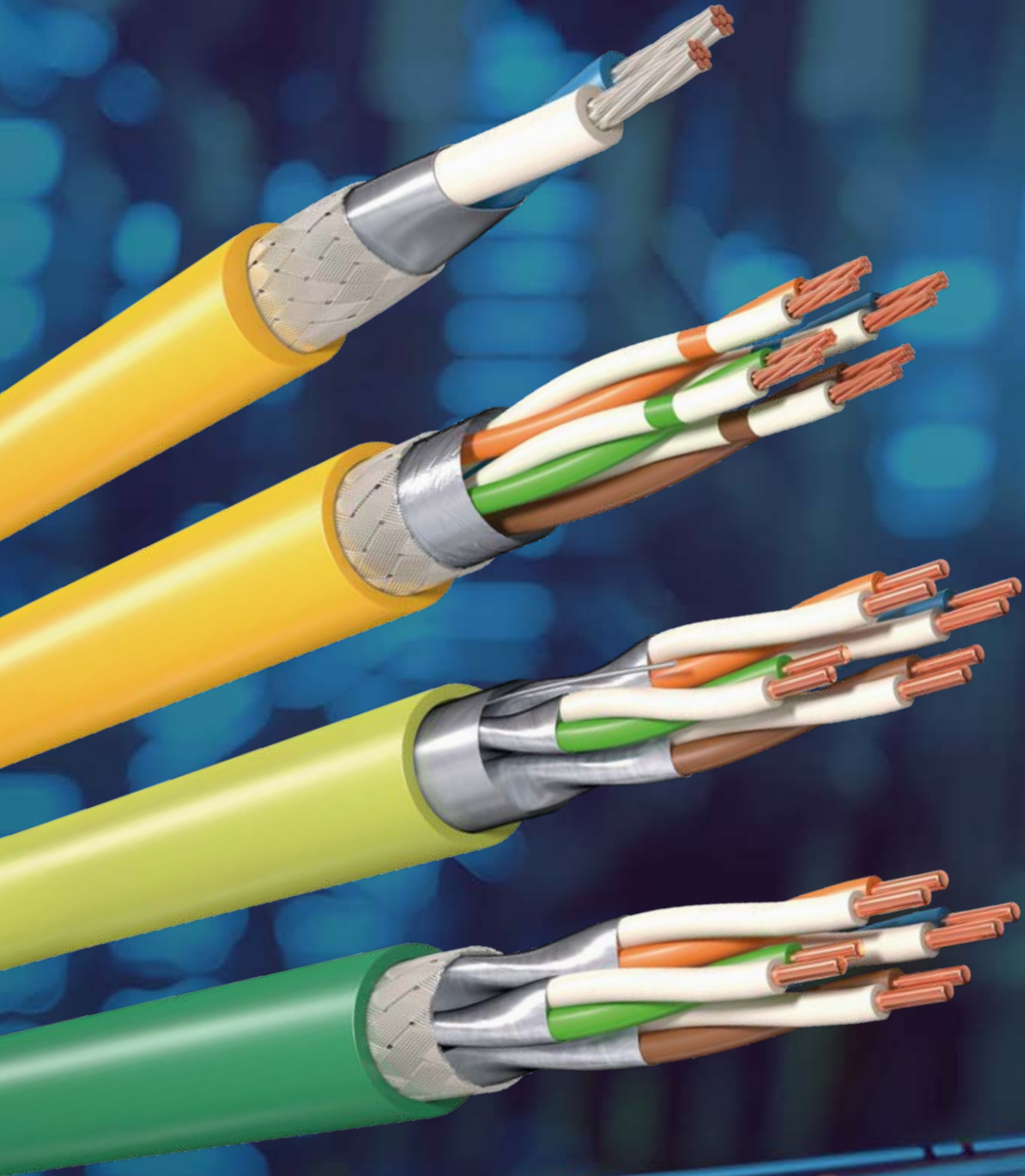

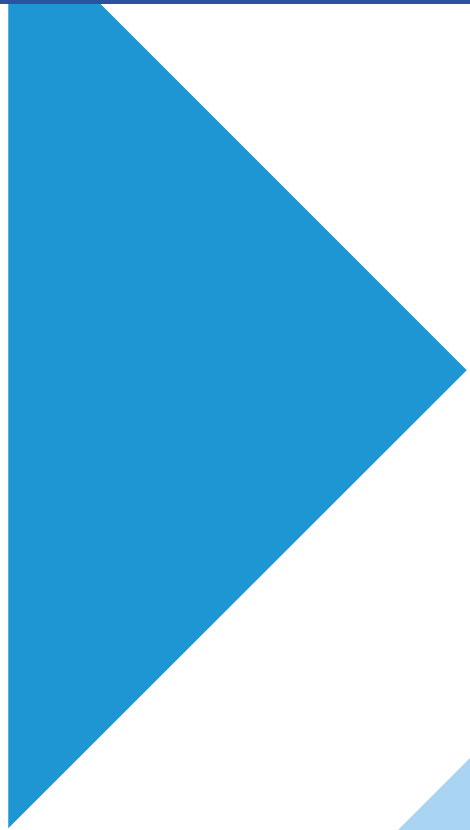

# KERPEN DATACOM

[www.kerpen-data.com](http://www.kerpen-data.com)

## KERPEN DATACOM NEWS

Further catalogues on the topics of **Mega-Line**®, **GigaLine**® and **VarioLine**® connection systems can be found on the Internet.

With up-to-date information services, such as the KERPEN DATACOM newsletter, we keep you informed on the latest developments at KERPEN DATACOM and in the market.

### Visit our homepage:

It is full of all the information you need

- ▶ Product and company news
- ▶ Professional articles
- ▶ Trade fairs, seminars and road shows
- ▶ Texts for invitations to tenders
- ▶ Standardisations/certification programmes

### KERPEN DATACOM GmbH

Zweifaller Straße 275–287  
52224 Stolberg, Germany  
Germany  
+49 24 02 17 1  
[info@kerpen-data.com](mailto:info@kerpen-data.com)

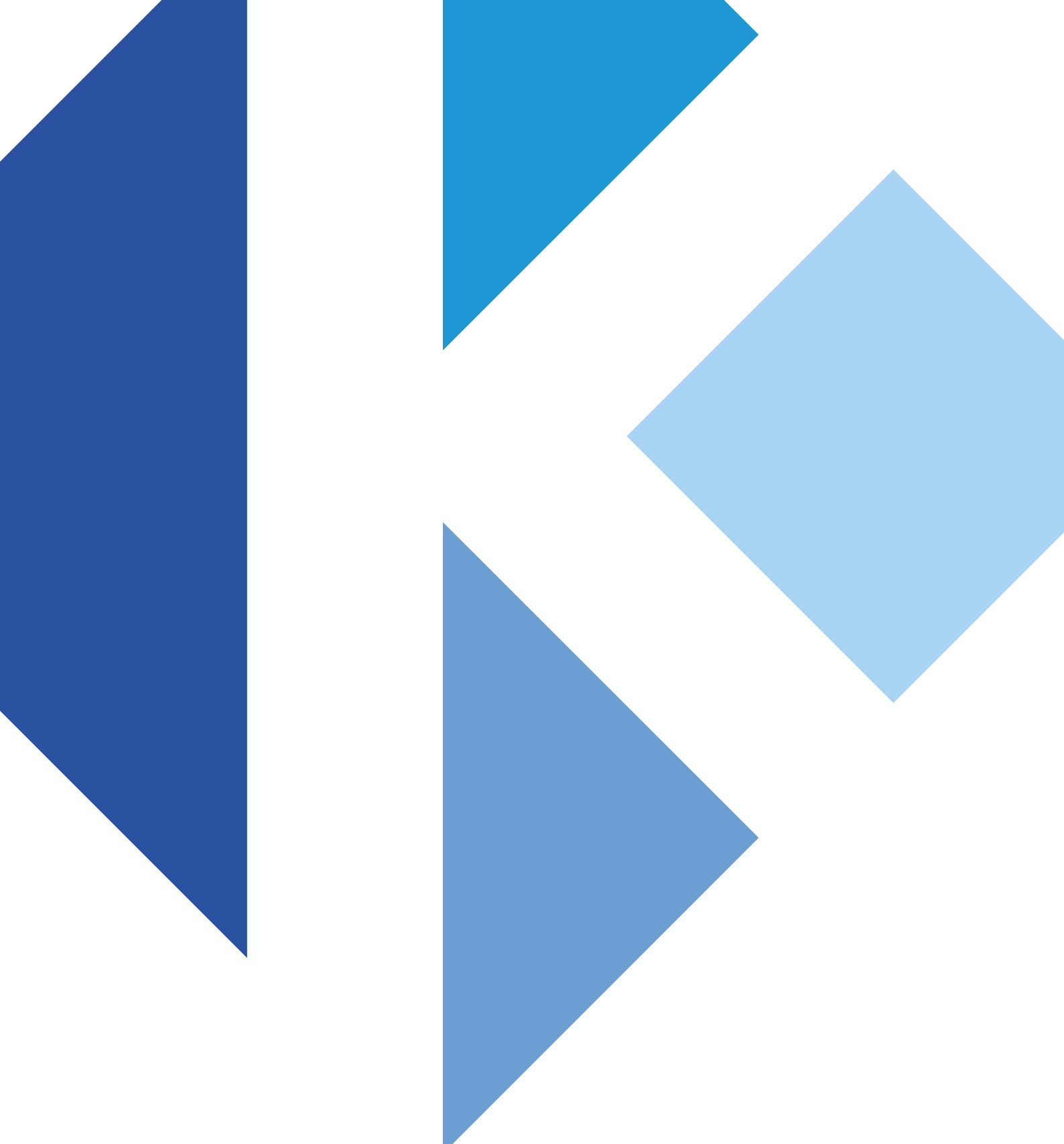

**KERPEN DATACOM GmbH**

[www.kerpen-data.com](http://www.kerpen-data.com)

[info@kerpen-data.com](mailto:info@kerpen-data.com)