

HG-SERIES

Magnetic Contactors & Overload Relays



LV & MV Circuit Breakers

MAGNETIC CONTACTORS & OVERLOAD RELAYS

CONTENTS

08 External Structure and Contents of Nameplate / 16 Model Selection Table /
20 Rating and Selection / 46 Accessories / 56 Technical Information /
74 Order Information / 77 Dimensions

HG-SERIES

Globalization of Technology



HG-SERIES

Magnetic Contactors & Overload Relays

Motor Protection Solutions that can be applied to various industrial systems to achieve improved durability and insulation performance.

- Various Product Ranges: 9 - 800 A (8 frames)
- Rated Insulation Voltage: 1000 V (50 A -)
- Reduced Installing Space by Upper Arrayed Structure of Auxiliary Contacts
- Direct Mounting Structure for Thermal Overload Relay
- Power Consumption Reduction Type Auxiliary Relay
- Safety Protection Cover for TOR
- AC/DC Free Voltage (115 A -)
- Standards and Certifications: KERI CB, Marine Approvals (7's Classifications)



GOOD DESIGN



DESIGN
AWARD
2016



HG-SERIES

Magnetic Contactor HGC 9 - 800 AF

Thermal Overload Relays HGT 9 - 800 AF

Contactor
(HGC)



Overload
Relay
(HGT)



18 AF

40 AF

65 AF

100 AF

HGC
Rated Current
Rated Insulation
Voltage

9, 12, 18 A
750 V

25, 32, 40 A
750 V

50, 65 A
1,000 V

75, 85, 100 A
1,000 V

HGT
Setting Current
Protection Grade

0.12 - 18 A
Class 10A

7 - 40 A
Class 10A

7 - 65 A
Class 10A

17 - 100 A
Class 10A

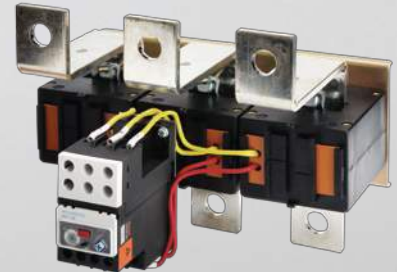
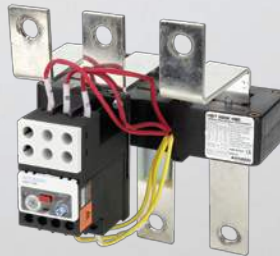

150 AF

265 AF

500 AF

800 AF

115, 130, 150 A
1,000 V

185, 225, 265 A
1,000 V

300, 400, 500 A
1,000 V

630, 800 A
1,000 V

48 - 150 A
Class 10A

48 - 265 A
Class 10A

90 - 500 A
Class 10A

378 - 800 A
Class 10A

External Structure and Contents of Nameplate

Magnetic Contactors

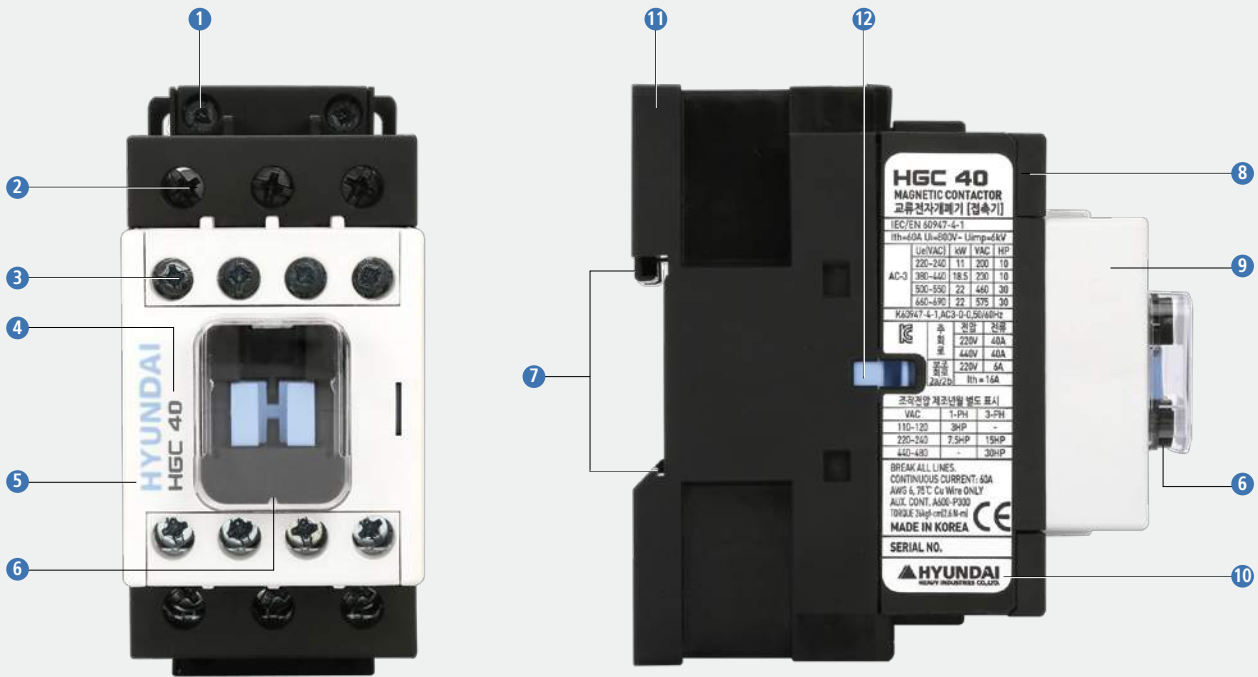

- ① Control Power Terminal
- ② Main Terminal
- ③ Auxiliary Terminal
- ④ Type Name
- ⑤ Manufacturer Name
- ⑥ Safety Cover
- ⑦ Din-Rail Mounting Part
- ⑧ Upper Frame
- ⑨ Upper Cover
- ⑩ Name Plate
- ⑪ Screw Mounting Hole
- ⑫ Mounting Hole for Auxiliary Devices on Sides

Type Name	HGC 40																					
	MAGNETIC CONTACTOR																					
	교류전자개폐기 [접속기]																					
	IEC/EN 60947-4-1	Standards																				
	Ith=60A Ui=800V-Uimp=6kV																					
Ratings	<table border="1"> <thead> <tr> <th>Ue(VAC)</th> <th>kW</th> <th>VAC</th> <th>HP</th> </tr> </thead> <tbody> <tr> <td>220-240</td> <td>11</td> <td>200</td> <td>10</td> </tr> <tr> <td>AC-3 380-440</td> <td>18.5</td> <td>230</td> <td>10</td> </tr> <tr> <td>500-550</td> <td>22</td> <td>460</td> <td>30</td> </tr> <tr> <td>660-690</td> <td>22</td> <td>575</td> <td>30</td> </tr> </tbody> </table>	Ue(VAC)	kW	VAC	HP	220-240	11	200	10	AC-3 380-440	18.5	230	10	500-550	22	460	30	660-690	22	575	30	
Ue(VAC)	kW	VAC	HP																			
220-240	11	200	10																			
AC-3 380-440	18.5	230	10																			
500-550	22	460	30																			
660-690	22	575	30																			
	K60947-4-1, AC3-0-0,50/60Hz																					
KC Mark and Number	<table border="1"> <thead> <tr> <th>주 회 로</th> <th>전압</th> <th>전류</th> </tr> </thead> <tbody> <tr> <td>220V</td> <td>40A</td> <td></td> </tr> <tr> <td>440V</td> <td>40A</td> <td></td> </tr> <tr> <td>보조 회로</td> <td>220V</td> <td>6A</td> </tr> <tr> <td>2a/2b</td> <td>Ith = 16A</td> <td></td> </tr> </tbody> </table>	주 회 로	전압	전류	220V	40A		440V	40A		보조 회로	220V	6A	2a/2b	Ith = 16A							
주 회 로	전압	전류																				
220V	40A																					
440V	40A																					
보조 회로	220V	6A																				
2a/2b	Ith = 16A																					
	<table border="1"> <thead> <tr> <th>VAC</th> <th>1-PH</th> <th>3-PH</th> </tr> </thead> <tbody> <tr> <td>110-120</td> <td>3HP</td> <td>-</td> </tr> <tr> <td>220-240</td> <td>7.5HP</td> <td>15HP</td> </tr> <tr> <td>440-480</td> <td>-</td> <td>30HP</td> </tr> </tbody> </table>	VAC	1-PH	3-PH	110-120	3HP	-	220-240	7.5HP	15HP	440-480	-	30HP	UL Rating								
VAC	1-PH	3-PH																				
110-120	3HP	-																				
220-240	7.5HP	15HP																				
440-480	-	30HP																				
	BREAK ALL LINES. CONTINUOUS CURRENT: 60A AWG & 75°C Cu Wire ONLY AUX. CONT. A600-P300 TORQUE 24kgf-cm(2.4 N-m)																					
Country of Origin	MADE IN KOREA																					
	SERIAL NO. _____	Serial No.																				
HHI Logo	HYUNDAI HEAVY INDUSTRIES CO., LTD.	Manufacturer																				

Thermal Overload Relay

Protection Cover

- Operating side is covered with protection cover in order not to change the settings and any operating arbitrarily.
- In order to change the settings, it can be changed by lifting up the protection cover.

Test Button

- When motor needs emergency stop during operation, it is possible to stop the motor by cutting off its contact from the magnetic contact with test button.
- In order to test the operation of thermal overload relay contacts, immediate testing is possible by pulling up test button which changes NO/NC contact.

Current Setting Knob

It is possible to set the rated current as 3 steps by using a +/- screwdriver.

Reset Button

A (Auto) Mode: Auto reset

H (Manual) Mode: Manual reset

Main Circuit Terminal

Screw type terminal is standard model, but for 40 - 100 AF, Lug type is available as an option.

Safety Structures of TOR

- Attachment of protection cover
 - Prevents test function during operation and misoperation by user.
- Separation of reset button and test button
 - Prevents malfunction during operation.

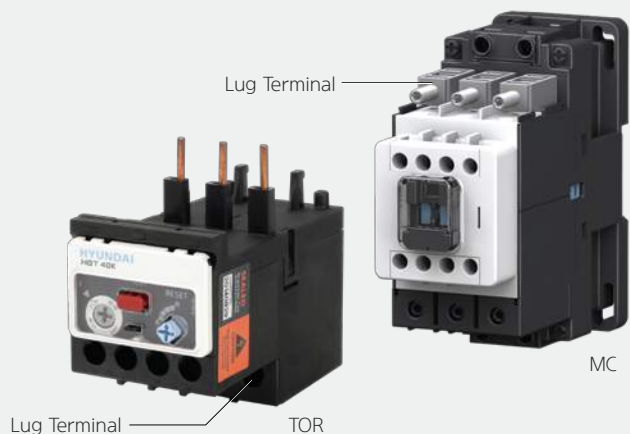
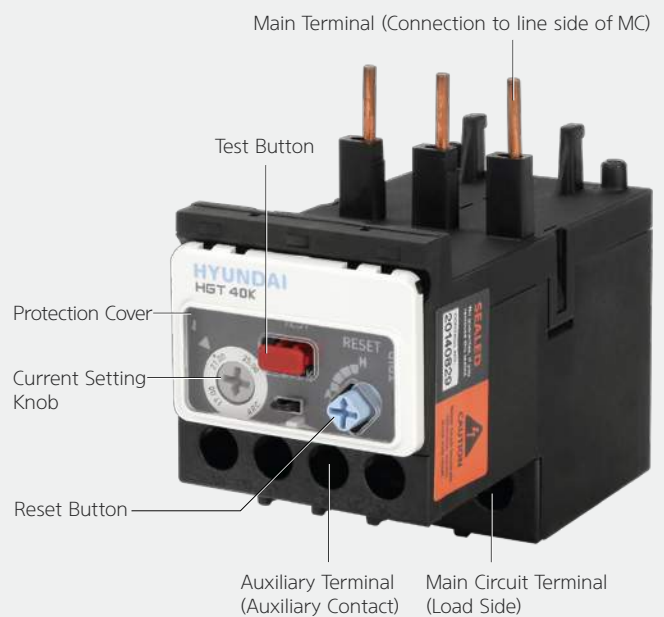

Magnetic Contactor (HGC)

9 - 100 AF

Enhanced Safety

Front Protection Cover

- Minimize foreign input
- Prevent unexpected operation due to user's error

Sealed Structure of Mounting Hole for Auxiliary Devices

- Obstructed by contact bridge when MC is ON / OFF

Removable Terminal Cover

- Applicable for main contact, auxiliary contact, coil contact
- IP20

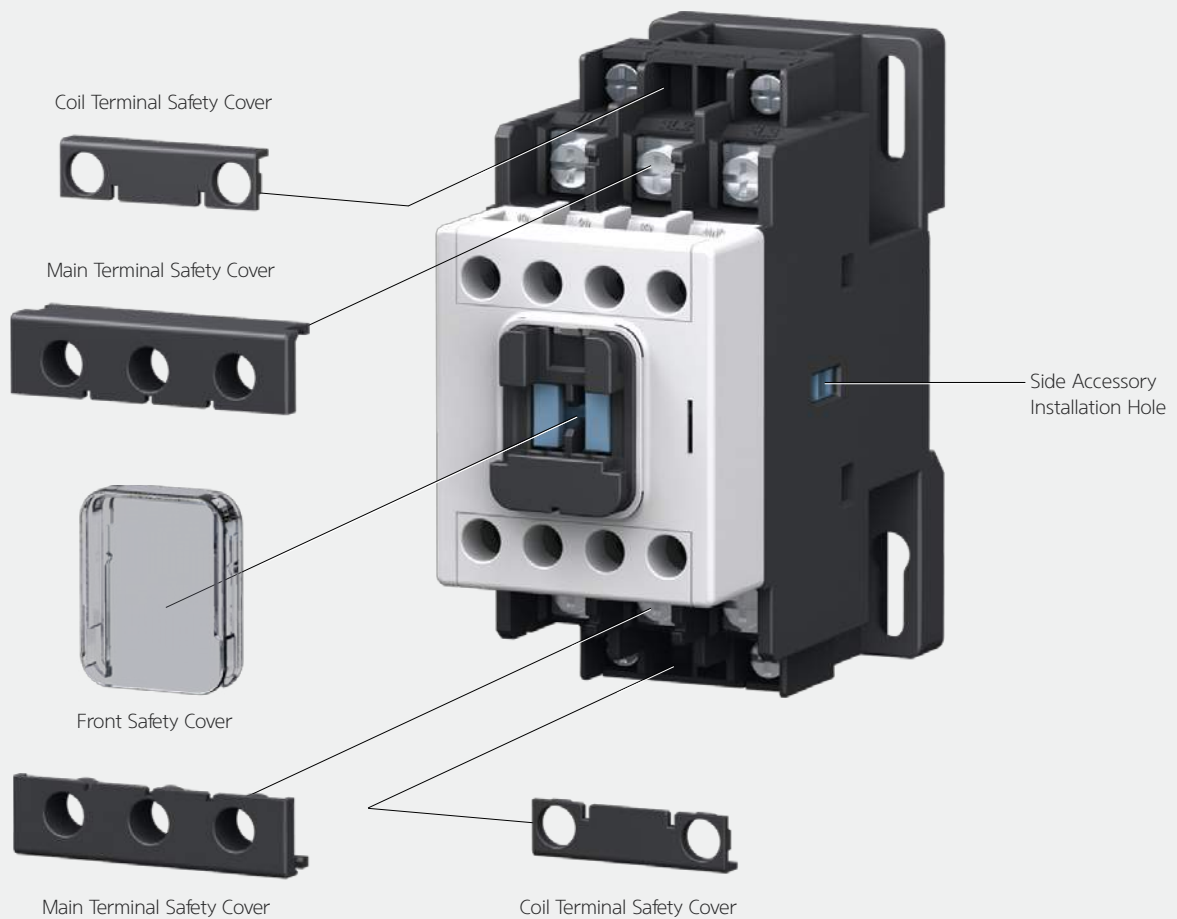

Improved Customer's Convenience

Upper Arrayed Auxiliary Contacts

- Easy wiring control cable. (default, 2a2b)

Easy Coil Replacement Structure

- Easy maintenance and replacement in attached status on switchgear

Various Attachment Methods on Switchgear

- DIN rail and screw type

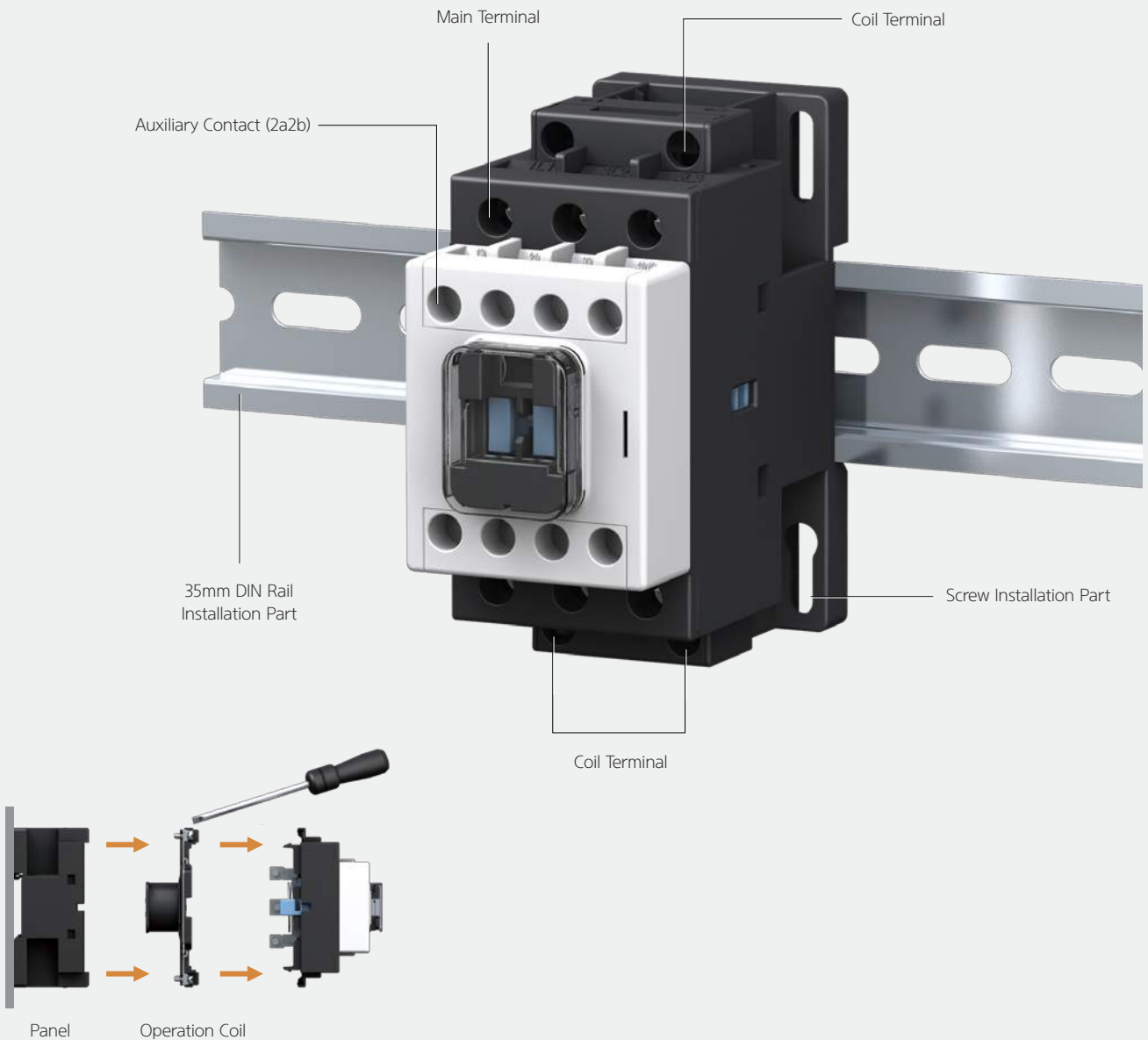

Magnetic Contactor (HGC)

9 - 100 AF

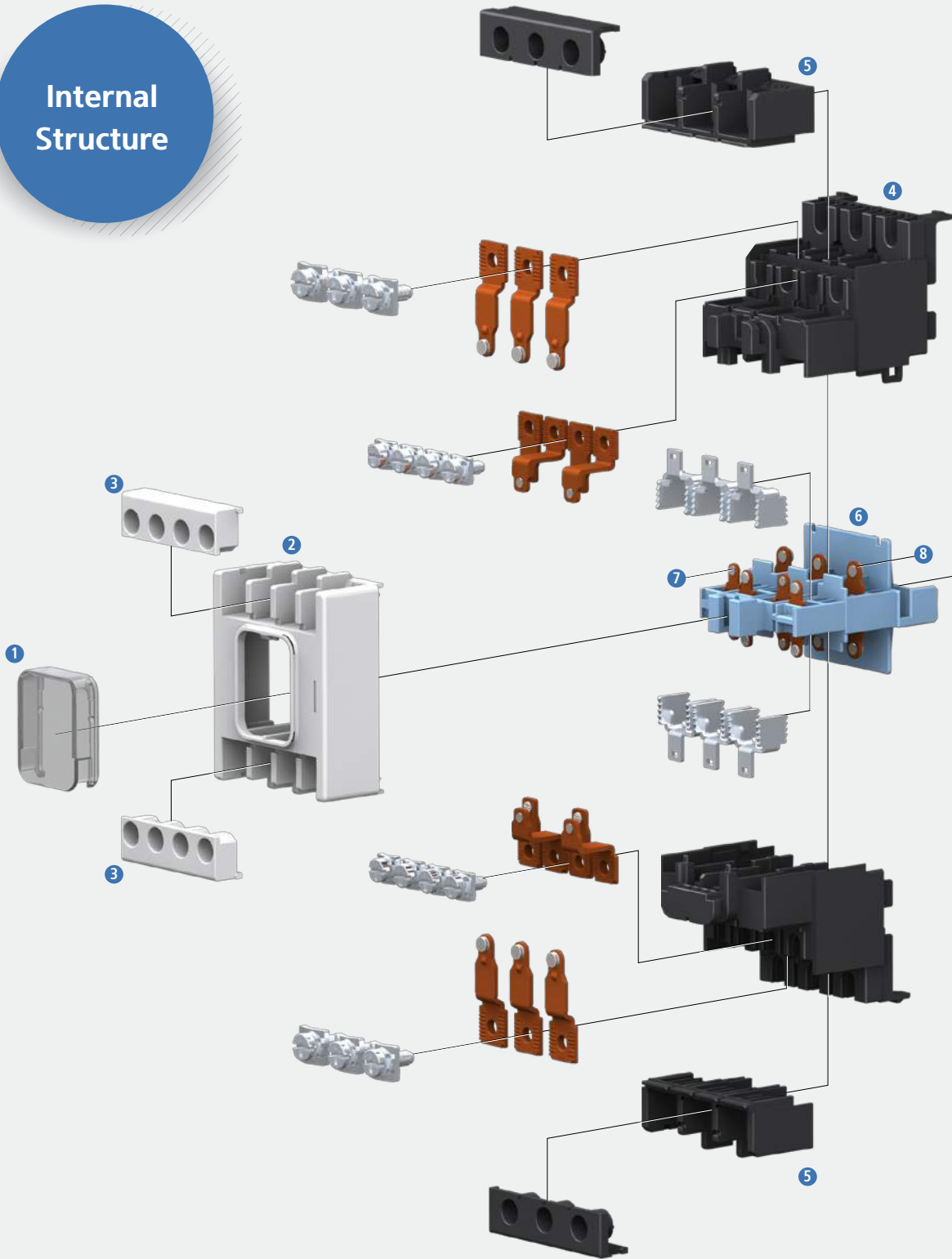
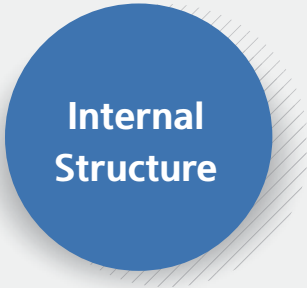

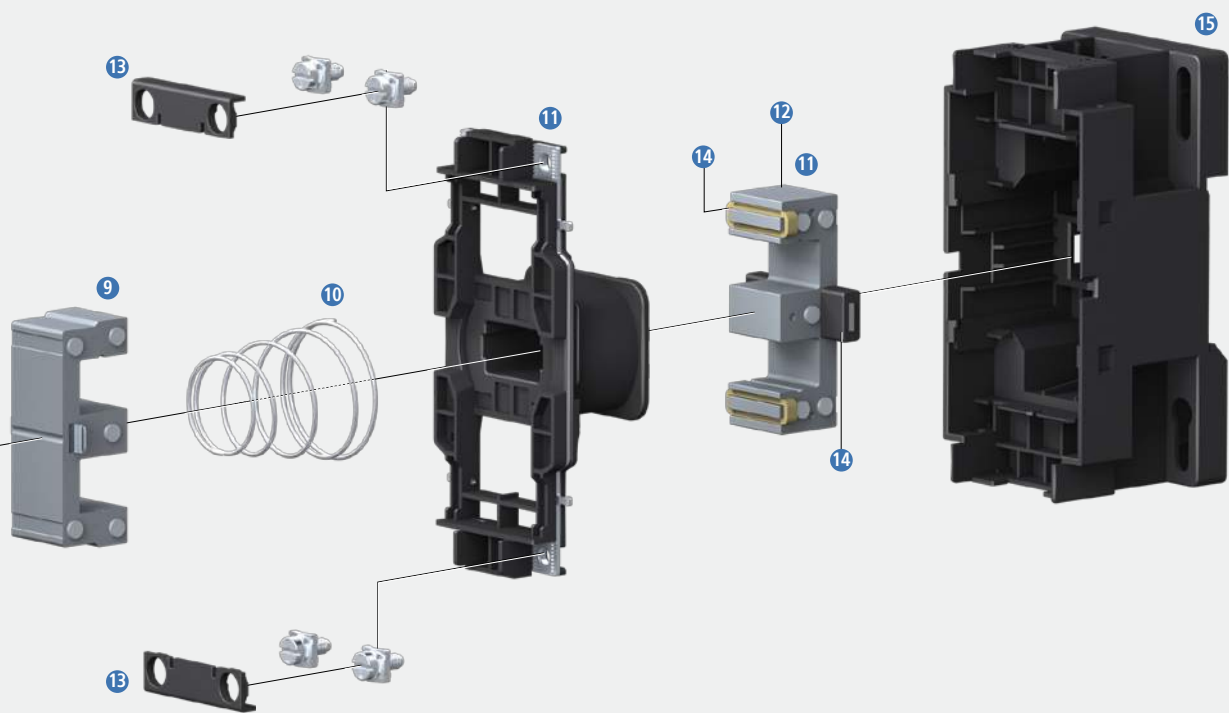

- ① Safety Cover: Prevents pushing contact bridge arbitrary.
- ② Top Cover: Assembles arc chamber. auxiliary contact part is stored inside.
- ③ Auxiliary Terminal Protection Cover: Protects users from electrical parts
- ④ Arc Chamber: Cuts off arc during on/off
- ⑤ Screw Terminal: Device to connect terminals
- ⑥ Contact Bridge: Assembled with a move contact and a move core to operate on/off. Assembly mounting hole is stored inside.
- ⑦ Auxiliary Contact: Operational point of auxiliary contact terminal
- ⑧ Moving Contact: Operational point of main contact terminal
- ⑨ Moving Core: Magnetic contactor is closed when coil is energized and it moves core slides into fixed core.
- ⑩ Return Spring: When coil is de-energized, it separates move core from fixed core.
- ⑪ Coil Assembly: Energized part to make fixed core an electromagnet
- ⑫ Fixed Core: The part where it becomes an electromagnet when coil is energized.
- ⑬ Coil Protection Cover: Protects the user from energized coil
- ⑭ Rubber Damper: Reduces on/off operation impact on magnetic contact.
- ⑮ Frame: The bottom part of magnetic contact that stores coil and fixed core

Magnetic Contactor (HGC)

115 - 800 AF

Easy Coil Replacement

- Easy maintenance and replacement without removal from switchgear
- Applying plastic case to fix coil unit
 - Minimizes movement of coil unit

Design for Noise Reduction

- DC energizing method using electronic circuit

Wide Range of Coil Control Voltage

Nominal Voltage	Rated Voltage (AC/DC)
24 V	AC: 24 - 26 V, DC: 24 V
48 V	AC: 44 - 52 V, DC: 48 V
220 V	AC: 100 - 240 V, DC: 110 - 220 V
440 V	AC: 380 - 450 V

※ Rated voltage depending on the types
(Table is only for HGC115 - 265)

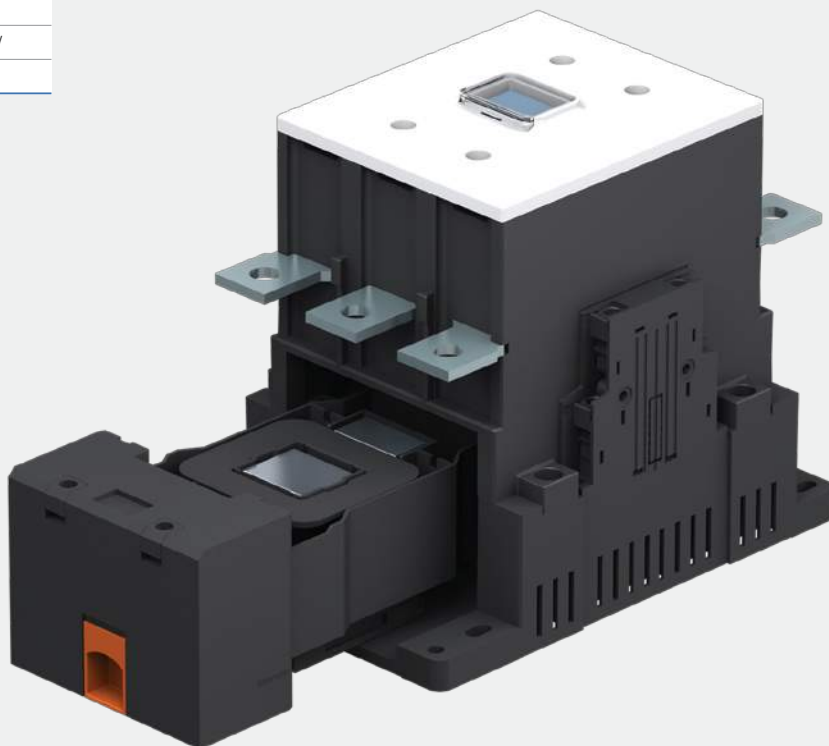

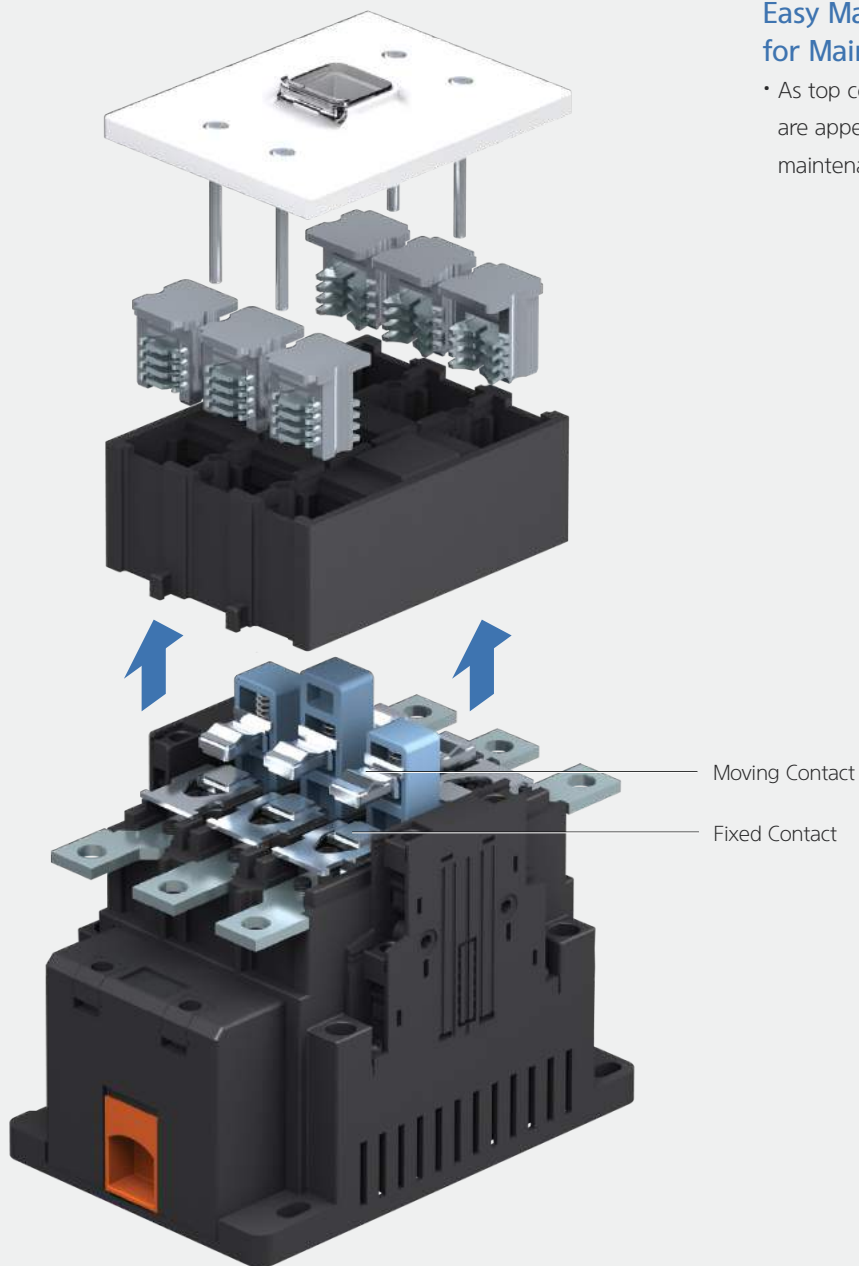

Easy Maintenance and Replacement for Main Contacts

- As top cover is disassembled, main contacts are appeared outwardly to have easy maintenance and testing from outside.

Model Selection Table

Magnetic Contactors: 9 - 100 AF



Model				HGC9	HGC12	HGC18	HGC25	HGC32	HGC40	
IEC 60947-4	Rated Insulation Voltage [U _i]		V	750	750	750	750	750	750	
	Rated Operational Voltage [U _e]		V	690	690	690	690	690	690	
	Rated Impulse Withstand Voltage [U _{imp}]		kV	6	6	6	6	6	6	
	Rated Thermal Current [I _{th}] (AC1)		A	25	25	40	45	55	60	
	AC3	200 - 240 V		kW/A	2.5/9	3.5/12	4.5/18	5.5/25	7.5/32	11/40
		380 - 440 V			4/9	5.5/12	7.5/18	11/25	15/32	18.5/40
		500 - 550 V			4/7	7.5/12	8.5/13	15/22	18.5/28	22/32
		660 - 690 V			4/6	7.5/9	7.5/9	15/17	18.5/20	22/23
		1,000 V			-	-	-	-	-	-
	Lifetime	Electrical	10,000 Times	250	250	250	250	200	200	
Mechanical		1,500		1,500	1,500	1,500	1,500	1,500		
AC4	200 - 240 V		kW/A	1.5/8	2.2/11	3.7/16	3.7/18	4.5/22	5.5/25	
	380 - 440 V			2.2/6	4/9	4/11	5.5/13	7.5/17	11/24	
	Electrical Lifetime		10,000 Times	3	3	3	3	3	3	
Mounting Method				Screw & DIN-Rail			Screw & DIN-Rail			
Contacts	Main	AC	1NO1NC or 2NO2NC			1NO1NC or 2NO2NC				
		DC	1NO1NC or 2NO2NC			1NO1NC or 2NO2NC				
	Auxilliary	AC	2NO2NC			2NO2NC				
		DC	2NO2NC			2NO2NC				
Dimensions	AC	W x H x D	mm	45 x 94.2 x 91.1			45 x 99.6 x 96.6			
	DC			45 x 94.2 x 124			45 x 99.6 x 129.5			

Model				HGC50	HGC65	HGC75	HGC85	HGC100	
IEC 60947	Rated Insulation Voltage [U _i]		V	1,000	1,000	1,000	1,000	1,000	
	Rated Operational Voltage [U _e]		V	690	690	690	690	690	
	Rated Impulse Withstand Voltage [U _{imp}]		kV	8	8	8	8	8	
	Rated Thermal Current [I _{th}] (AC1)		A	70	85	115	125	145	
	AC3	200 - 240 V		kW/A	15/50	18.5/65	22/75	25/85	30/100
		380 - 440 V			22/50	30/65	37/75	45/85	55/100
		500 - 550 V			30/43	33/60	37/64	50/75	55/85
		660 - 690 V			30/28	33/35	37/42	45/45	50/65
		1,000 V			-	-	-	-	-
	Lifetime	Electrical	10,000 Times	200	200	200	200	200	
Mechanical		1,500		1,500	1,000	1,000	1,000		
AC4	200 - 240 V		kW/A	7.5/35	11/50	13/55	15/65	17/72	
	380 - 440 V			15/32	22/47	25/52	30/62	33/68	
	Electrical Lifetime		10,000 Times	3	3	3	3	3	
Mounting Method				Screw & DIN-Rail			Screw & DIN-Rail		
Contacts	Main	AC	1NO1NC or 2NO2NC			1NO1NC or 2NO2NC			
		DC	2NO1NC			2NO1NC			
	Auxilliary	AC	2NO2NC			2NO2NC			
		DC	1NO1NC			1NO1NC			
Dimensions	AC	W x H x D	mm	55 x 123.6 x 129			70 x 146 x 153		
	DC			55 x 123.6 x 129			70 x 146 x 153		

Thermal Overload Relays: 18 - 100 AF



Model (Basic)			HGT18	HGT40	HGT65	HGT100
3 Phase, 2 Elements			HGT18H	HGT40H	HGT65H	HGT100H
3 Phase, 3 Elements (Loss Phase Protection)			HGT18K	HGT40K	HGT65K	HGT100K
Nominal Current	A		0.12 - 18	7 - 40	7 - 65	17 - 100
Setting Current (Min. - Max.)	A		0.12 - 0.18	7 - 10	7 - 10	17 - 25
			0.18 - 0.26	8 - 12	8 - 12	22 - 32
			0.25 - 0.35	12 - 18	12 - 18	28 - 40
			0.34 - 0.5	15 - 22	15 - 22	34 - 50
			0.5 - 0.7	17 - 25	17 - 25	45 - 65
			0.6 - 0.9	22 - 32	22 - 32	52 - 75
			0.8 - 1.2	28 - 40	28 - 40	59 - 85
			1.1 - 1.6		34 - 50	70 - 100
			1.5 - 2.1		45 - 65	
			2 - 3			
			2.8 - 4.2			
			3 - 5			
			4 - 6			
			5.6 - 8			
	6 - 9					
	8 - 12					
	12 - 18					
Auxiliary Contacts			1NO1NC	1NO1NC	1NO1NC	1NO1NC
Reset			Manual & Automatic	Manual & Automatic	Manual & Automatic	Manual & Automatic
Dimensions	W x H x D	mm	45 x 78.2 x 82.7	45 x 80.7 x 95.5	55 x 89.3 x 110.7	70 x 105 x 128.1

Model Selection Table

Magnetic Contactors: 115 - 800 AF



Model			HGC115	HGC130	HGC150	HGC185	HGC225	HGC265		
IEC 60947-4	Rated Insulation Voltage [Ui]		V	1,000	1,000	1,000	1,000	1,000		
	Rated Operational Voltage [Ue]		V	1,000	1,000	1,000	1,000	1,000		
	Rated Impulse Withstand Voltage [Uimp]		kV	8	8	8	8	8		
	Rated Thermal Current [Ith] (AC1)		A	160	180	210	275	315	350	
	AC3	200 - 240 V		kW/A	37/115	40/130	45/150	55/185	75/225	80/265
		380 - 440 V			60/115	65/130	75/150	90/185	132/225	147/265
		500 - 550 V			59/100	70/120	90/140	110/180	132/200	150/225
		660 - 690 V			55/65	75/82	90/120	110/120	132/150	160/173
		1,000 V			65/50	75/54	90/66	110/78	132/96	160/113
	Lifetime	Electrical	10,000 Times	100	100	100	100	100	100	
Mechanical		500		500	500	500	500	500		
AC4	200 - 240 V		kW/A	19/80	22/93	30/125	37/150	45/185	50/200	
	380 - 440 V			37/75	45/90	55/110	75/150	90/185	102/200	
	Electrical Lifetime		10,000 Times	3	3	3	3	3	3	
Mounting Method			Screw			Screw				
Contacts	Main		2NO2NC			2NO2NC				
	Auxiliary		2NO2NC			2NO2NC				
Dimensions	W x H x D	mm	103 x 155 x 145.1			138 x 204 x 174.2				

Model			HGC300	HGC400	HGC500	HGC630	HGC800		
IEC 60947	Rated Insulation Voltage [Ui]		V	1,000	1,000	1,000	1,000	1,000	
	Rated Operational Voltage [Ue]		V	1,000	1,000	1,000	1,000	1,000	
	Rated Impulse Withstand Voltage [Uimp]		kV	8	8	8	8	8	
	Rated Thermal Current [Ith] (AC1)		A	400	500	550	750	900	
	AC3	200 - 240 V		kW/A	90/300	125/400	140/500	190/630	220/800
		380 - 440 V			160/300	220/400	250/500	330/630	440/800
		500 - 550 V			200/273	250/300	300/426	330/500	500/720
		660 - 690 V			200/220	250/300	335/360	400/412	500/630
		1,000 V			200/141	250/178	275/192	300/213	400/284
	Lifetime	Electrical	10,000 Times	100	100	50	50	50	
Mechanical		500		500	500	500	500		
AC4	200 - 240 V		kW/A	55/220	75/300	90/350	110/400	160/630	
	380 - 440 V			110/220	150/300	175/350	200/400	300/630	
	Electrical Lifetime		10,000 Times	3	3	3	3	3	
Mounting Method			Screw			Screw			
Contacts	Main		2NO2NC			2NO2NC			
	Auxiliary		2NO2NC			2NO2NC			
Dimensions	W x H x D	mm	163 x 243 x 203			276 x 314 x 255.3			

Thermal Overload Relays: 150 - 800 AF

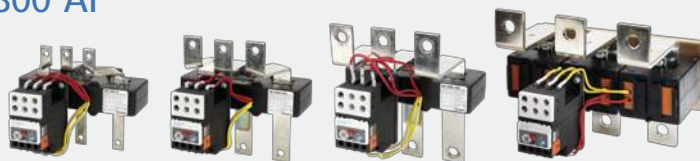

Model (Basic)			HGT150	HGT265	HGT500	HGT800
3 Phase, 2 Elements			HGT150H	HGT265H	HGT500H	HGT800H
3 Phase, 3 Elements (Loss Phase Protection)			HGT150K	HGT265K	HGT500K	HGT800K
Nominal Current	A		48 - 150	48 - 265	90 - 500	378 - 800
Setting Current (Min. - Max.)	A		48 - 80	48 - 80	90 - 150	378 - 630
			69 - 115	69 - 115	111 - 185	480 - 800
			78 - 130	78 - 130	135 - 225	
			90 - 150	90 - 150	159 - 265	
Auxiliary Contacts			1NO1NC	1NO1NC	1NO1NC	1NO1NC
Reset			Manual & Automatic	Manual & Automatic	Manual & Automatic	Manual & Automatic
Dimensions	W x H x D	mm	180 x 159 x 179.3	180 x 185 x 179.3	180 x 205.2 x 179.3	245 x 197 x 209.9

Rating and Selection

Magnetic Contactor: HGC 9 - 18 A

Rating



Model				HGC9	HGC12	HGC18	
IEC 60947-4	Rated Insulation Voltage [U _i]		V	750	750	750	
	Rated Operational Voltage [U _e]		V	690	690	690	
	Rated Impulse Withstand Voltage [U _{imp}]		kV	6	6	6	
	Rated Thermal Current [I _{th}] (AC1)		A	25	25	40	
	AC3	200 - 240 V		kW/A	2.5/9	3.5/12	4.5/18
		380 - 440 V			4/9	5.5/12	7.5/18
		500 - 550 V			4/7	7.5/12	8.5/13
		660 - 690 V			4/6	7.5/9	7.5/9
		1,000 V			-	-	-
	Lifetime	Electrical	10,000 Times	250	250	250	
		Mechanical		1,500	1,500	1,500	
	AC4	200 - 240 V		kW/A	1.5/8	2.2/11	3.7/16
		380 - 440 V			2.2/6	4/9	4/11
		Electrical Lifetime			10,000 Times	3	3
	AC1,2,3 Operating Frequency (per hour)	100 % load		Times	1,000	1,000	1,000
50 % load (DC)		2,000	2,000		2,000		
20 % load (DC)		3,600	3,600		3,600		
AC4 Operation Frequency (per hour)	100 % load		Times	300	300	300	
	50 % load			600	600	600	
Making Capacity	220 V		A	110	130	180	
	440 V			90	120	180	
Breaking Capacity	220 V		A	88	104	144	
	440 V			72	96	144	
Mounting Method				Screw & DIN-Rail			
Contacts	Main	AC		1NO1NC or 2NO2NC			
		DC		1NO1NC or 2NO2NC			
		AC/DC		-			
	Auxiliary	AC		2NO2NC			
		DC		2NO2NC			
AC/DC		-					
Dimensions	AC	W x H x D	mm	45 x 94.2 x 91.1			
	DC			45 x 94.2 x 124			
	AC/DC			-			
Weight	AC		kg	0.4			
	DC			0.6			
	AC/DC			-			
Contact Arrangement							
Main	Main	3a					
	Auxiliary	2a2b					
Main + Auxiliary (2a2b)	Main	3a					
	Auxiliary	4a4b					

※ - Auxiliary Contacts Usage: Please refer to 48 - 49 page

- 1) Possible auxiliary contacts combination -> A Contact: maximum 6a, B Contact: maximum 4b
- 2) When using 4a4b by side auxiliary block, front auxiliary block is not applicable.
- 3) When using main 2a2b, front auxiliary block is applicable.

Accessories

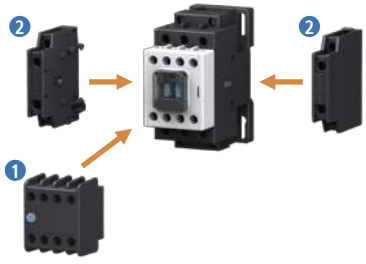
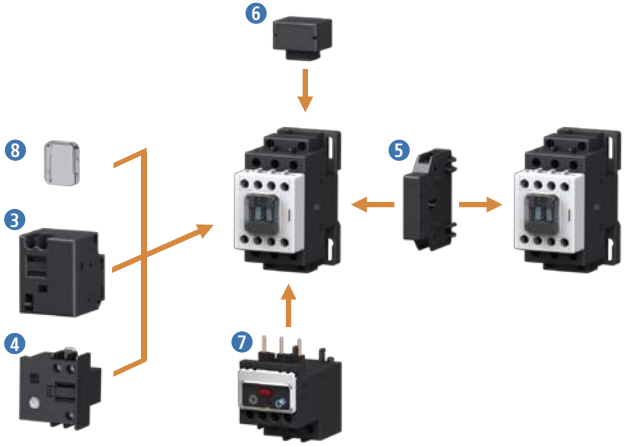
Auxilliary Contacts	Other Accessories
	
<p>1 Auxilliary Contact Block (Front Mounting) HGC TB - 48 page</p> <p>2 Auxilliary Contact Block (Side Mounting) HGC SB 40 - 48 page</p>	<p>3 Mechanical Latching Block HGC LB 100 - 51 page</p> <p>4 Timer HGC ET - 53 page</p> <p>5 Mechanical Interlock Block HGC IU 40 - 50 page</p> <p>6 Surge Absorber HGC RC/CD 40 - 52 page</p> <p>7 Thermal Overload Relay HGT 18 - 36 page</p> <p>8 Front Safety Cover HGFC 100 - 55 page</p>

Order Information

• Standard Order (w/protection cover, w/o accessories) / Auxiliary Contacts: 2NO2NC

Operation Voltage (V)		HGC9	HGC12	HGC18
AC (60 Hz)	24	HGC9 22NS A24	HGC12 22NS A24	HGC18 22NS A24
	48	HGC9 22NS A48	HGC12 22NS A48	HGC18 22NS A48
	110	HGC9 22NS A110	HGC12 22NS A110	HGC18 22NS A110
	120	HGC9 22NS A120	HGC12 22NS A120	HGC18 22NS A120
	220	HGC9 22NS A220	HGC12 22NS A220	HGC18 22NS A220
	240	HGC9 22NS A240	HGC12 22NS A240	HGC18 22NS A240
	380	HGC9 22NS A380	HGC12 22NS A380	HGC18 22NS A380
	440	HGC9 22NS A440	HGC12 22NS A440	HGC18 22NS A440
AC (50 Hz)	24	HGC9 22NS X24	HGC12 22NS X24	HGC18 22NS X24
	48	HGC9 22NS X48	HGC12 22NS X48	HGC18 22NS X48
	110	HGC9 22NS X110	HGC12 22NS X110	HGC18 22NS X110
	120	HGC9 22NS X120	HGC12 22NS X120	HGC18 22NS X120
	220	HGC9 22NS X220	HGC12 22NS X220	HGC18 22NS X220
	240	HGC9 22NS X240	HGC12 22NS X240	HGC18 22NS X240
	380	HGC9 22NS X380	HGC12 22NS X380	HGC18 22NS X380
	440	HGC9 22NS X440	HGC12 22NS X440	HGC18 22NS X440
DC	24	HGC9 22NS D24	HGC12 22NS D24	HGC18 22NS D24
	48	HGC9 22NS D48	HGC12 22NS D48	HGC18 22NS D48
	110	HGC9 22NS D110	HGC12 22NS D110	HGC18 22NS D110
	125	HGC9 22NS D125	HGC12 22NS D125	HGC18 22NS D125
	220	HGC9 22NS D220	HGC12 22NS D220	HGC18 22NS D220

Rating and Selection

Magnetic Contactor: HGC 25 - 40 A

Rating



Model			HGC25	HGC32	HGC40		
IEC 60947	Rated Insulation Voltage [U _i]		V	750	750	750	
	Rated Operational Voltage [U _e]		V	690	690	690	
	Rated Impulse Withstand Voltage [U _{imp}]		kV	6	6	6	
	Rated Thermal Current [I _{th}] (AC1)		A	45	55	60	
	AC3	200 - 240 V		kW/A	5.5/25	7.5/32	11/40
		380 - 440 V			11/25	15/32	18.5/40
		500 - 550 V			15/22	18.5/28	22/32
		660 - 690 V			15/17	18.5/20	22/23
		1,000 V			-	-	-
	Lifetime	Electrical	10,000 Times	250	200	200	
		Mechanical		1,500	1,500	1,500	
	AC4	200 - 240 V		kW/A	3.7/18	4.5/22	5.5/25
		380 - 440 V			5.5/13	7.5/17	11/24
		Electrical Lifetime			10,000 Times	3	3
	AC1,2,3 Operating Frequency (per hour)	100 % load		Times	1,000	1,000	1,000
		50 % load (DC)			2,000	2,000	2,000
		20 % load (DC)			3,600	3,600	3,600
	AC4 Operationg Frequency (per hour)	100 % load		Times	300	300	250
50 % load		600	600		500		
Making Capacity	220 V		A	250	320	400	
	440 V			250	320	400	
Breaking Capacity	220 V		A	200	256	320	
	440 V			200	256	320	
Mounting Method			Screw & DIN-Rail				
Contacts	Main	AC	1NO1NC or 2NO2NC				
		DC	1NO1NC or 2NO2NC				
		AC/DC	-				
	Auxiliary	AC	2NO2NC				
		DC	2NO2NC				
AC/DC		-					
Dimensions	AC	W x H x D	mm	45 x 99.6 x 96.6			
	DC			45 x 99.6 x 129.5			
	AC/DC			-			
Weight	AC		kg	0.5			
	DC			0.65			
	AC/DC			-			
Contact Arrangement							
Main	Main	3a					
	Auxilliary	2a2b					
Main + Auxilliary (2a2b)	Main	3a					
	Auxilliary	4a4b					

※ - Auxiliary Contacts Usage: Please refer to 48 - 49 page

- 1) Possible auxiliary contacts combination -> A Contact: maximum 6a, B Contact: maximum 4b
- 2) When using 4a4b by side auxiliary block, front auxiliary block is not applicable.
- 3) When using main 2a2b, front auxiliary block is applicable.

Accessories

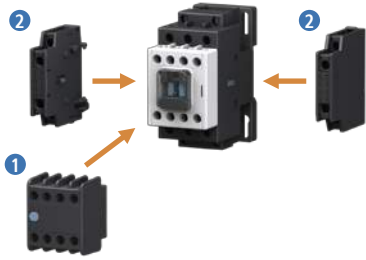
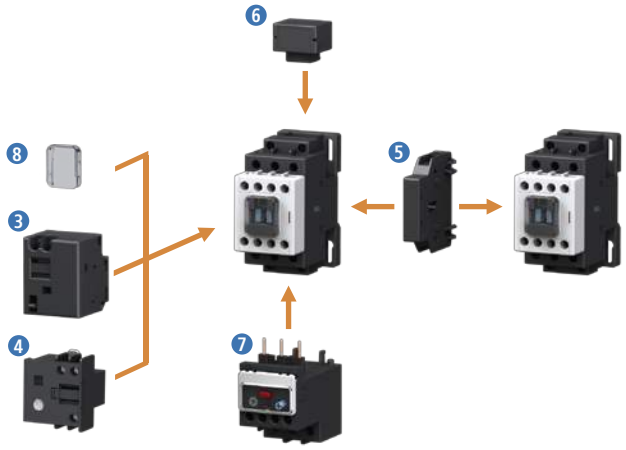
Auxilliary Contacts	Other Accessories	
		
<p>1 Auxilliary Contact Block (Front Mounting) HGC TB - 48 page</p> <p>2 Auxilliary Contact Block (Side Mounting) HGC SB 40 - 48 page</p>	<p>3 Mechanical Latching Block HGC LB 100 - 51 page</p> <p>4 Timer HGC ET - 53 page</p> <p>5 Mechanical Interlock Block HGC IU 40 - 50 page</p>	<p>6 Surge Absorber HGC RC/CD 40 - 52 page</p> <p>7 Thermal Overload Relay HGT 40 - 38 page</p> <p>8 Front Safety Cover HGFC 100 - 55 page</p>

Order Information

• Standard Order (w/protection cover, w/o accessories) / Auxiliary Contacts: 2NO2NC

Operation Voltage (V)		HGC25	HGC32	HGC40
AC (60 Hz)	24	HGC25 22NS A24	HGC32 22NS A24	HGC40 22NS A24
	48	HGC25 22NS A48	HGC32 22NS A48	HGC40 22NS A48
	110	HGC25 22NS A110	HGC32 22NS A110	HGC40 22NS A110
	120	HGC25 22NS A120	HGC32 22NS A120	HGC40 22NS A120
	220	HGC25 22NS A220	HGC32 22NS A220	HGC40 22NS A220
	240	HGC25 22NS A240	HGC32 22NS A240	HGC40 22NS A240
	380	HGC25 22NS A380	HGC32 22NS A380	HGC40 22NS A380
	440	HGC25 22NS A440	HGC32 22NS A440	HGC40 22NS A440
AC (50 Hz)	24	HGC25 22NS X24	HGC32 22NS X24	HGC40 22NS X24
	48	HGC25 22NS X48	HGC32 22NS X48	HGC40 22NS X48
	110	HGC25 22NS X110	HGC32 22NS X110	HGC40 22NS X110
	120	HGC25 22NS X120	HGC32 22NS X120	HGC40 22NS X120
	220	HGC25 22NS X220	HGC32 22NS X220	HGC40 22NS X220
	240	HGC25 22NS X240	HGC32 22NS X240	HGC40 22NS X240
	380	HGC25 22NS X380	HGC32 22NS X380	HGC40 22NS X380
	440	HGC25 22NS X440	HGC32 22NS X440	HGC40 22NS X440
DC	24	HGC25 22NS D24	HGC32 22NS D24	HGC40 22NS D24
	48	HGC25 22NS D48	HGC32 22NS D48	HGC40 22NS D48
	110	HGC25 22NS D110	HGC32 22NS D110	HGC40 22NS D110
	125	HGC25 22NS D125	HGC32 22NS D125	HGC40 22NS D125
	220	HGC25 22NS D220	HGC32 22NS D220	HGC40 22NS D220

Rating and Selection

Magnetic Contactor: HGC 50 - 65 A

Rating





Model				HGC50	HGC65		
IEC 60947	Rated Insulation Voltage [U _i]		V	1,000	1,000		
	Rated Operational Voltage [U _e]		V	690	690		
	Rated Impulse Withstand Voltage [U _{imp}]		kV	8	8		
	Rated Thermal Current [I _{th}] (AC1)		A	70	85		
	AC3	200 - 240 V		kW/A	15/50	18.5/65	
		380 - 440 V			22/50	30/65	
		500 - 550 V			30/43	33/60	
		660 - 690 V			30/28	33/35	
		1,000 V			-	-	
	Lifetime	Electrical	10,000	200	200		
				Mechanical	1,500	1,500	
	AC4	200 - 240 V		kW/A	7.5/35	11/50	
		380 - 440 V			15/32	22/47	
		Electrical Lifetime			10,000	3	3
	AC1,2,3	100 % load		Times	750	750	
		Operating Frequency (per hour)			50 % load (DC)	1,500 (900)	1,500 (900)
		20 % load (DC)			3,000 (1,200)	3,000 (1,200)	
	AC4 Operationg	100 % load		Times	250	250	
Frequency (per hour)		50 % load	500		500		
Making Capacity	220 V		A	500	650		
	440 V			500	650		
Breaking Capacity	220 V		A	400	520		
	440 V			400	520		
Mounting Method				Screw & DIN-Rail			
Contacts	Main	AC		2NO2NC			
		DC		2NO1NC			
		AC/DC		-			
	Auxilliary	AC		2NO2NC			
		DC		1NO1NC			
		AC/DC		-			
Dimensions	AC	W x H x D	mm	55 x 127.6 x 129.1			
	DC			55 x 127.6 x 129.1			
	AC/DC			-			
Weight	AC		kg	0.8			
	DC			0.8			
	AC/DC			-			
Contact Arrangement							
Main	Main	3a					
	Auxilliary	2a2b					
Main + Auxilliary (2a2b)	Main	3a					
	Auxilliary	4a4b					

※ - Auxiliary Contacts Usage: Please refer to 48 - 49 page

- 1) Possible auxiliary contacts combination -> A Contact: maximum 6a, B Contact: maximum 4b
- 2) When using 4a4b by side auxillary block, front auxillary block is not applicable.
- 3) When using main 2a2b, front auxillary block is applicable.

Accessories

Auxilliary Contacts	Other Accessories
	
<p>① Auxilliary Contact Block (Front Mounting) HGC TB - 48 page</p> <p>② Auxilliary Contact Block (Side Mounting) HGC SB 100 - 48 page</p>	<p>③ Mechanical Latching Block HGC LB 100 - 51 page</p> <p>④ Timer HGC ET - 53 page</p> <p>⑤ Mechanical Interlock Block HGC IU 100 - 50 page</p> <p>⑥ Surge Absorber HGC RC/CD100 - 52 page</p> <p>⑦ Thermal Overload Relay HGT 65 - 38 page</p> <p>⑧ Front Safety Cover HGFC 100 - 55 page</p>

Order Information

• Standard Order (w/protection cover, w/o accessories) / Auxiliary Contacts: 2NO2NC

Operation Voltage (V)		HGC50	HGC65
AC (60 Hz)	24	HGC50 22NS A24	HGC65 22NS A24
	48	HGC50 22NS A48	HGC65 22NS A48
	110	HGC50 22NS A110	HGC65 22NS A110
	120	HGC50 22NS A120	HGC65 22NS A120
	220	HGC50 22NS A220	HGC65 22NS A220
	240	HGC50 22NS A240	HGC65 22NS A240
	380	HGC50 22NS A380	HGC65 22NS A380
	440	HGC50 22NS A440	HGC65 22NS A440
AC (50 Hz)	24	HGC50 22NS X24	HGC65 22NS X24
	48	HGC50 22NS X48	HGC65 22NS X48
	110	HGC50 22NS X110	HGC65 22NS X110
	120	HGC50 22NS X120	HGC65 22NS X120
	220	HGC50 22NS X220	HGC65 22NS X220
	240	HGC50 22NS X240	HGC65 22NS X240
	380	HGC50 22NS X380	HGC65 22NS X380
	440	HGC50 22NS X440	HGC65 22NS X440
DC	24	HGC50 21NS D24	HGC65 21NS D24
	48	HGC50 21NS D48	HGC65 21NS D48
	110	HGC50 21NS D110	HGC65 21NS D110
	125	HGC50 21NS D125	HGC65 21NS D125
	220	HGC50 21NS D220	HGC65 21NS D220

Rating and Selection

Magnetic Contactor: HGC 75 - 100 A

Rating



Model			HGC75	HGC85	HGC100		
IEC 60947	Rated Insulation Voltage [U _i]		V	1,000	1,000	1,000	
	Rated Operational Voltage [U _e]		V	690	690	690	
	Rated Impulse Withstand Voltage [U _{imp}]		kV	8	8	8	
	Rated Thermal Current [I _{th}] (AC1)		A	115	125	145	
	AC3	200 - 240 V		kW/A	22/75	25/85	30/100
		380 - 440 V			37/75	45/85	55/100
		500 - 550 V			37/64	50/75	55/85
		660 - 690 V			37/42	45/45	50/65
		1,000 V			-	-	-
	Lifetime	Electrical	10,000 Times	200	200	200	
		Mechanical		1,000	1,000	1,000	
	AC4	200 - 240 V		kW/A	13/55	15/65	17/72
		380 - 440 V			25/52	30/62	33/68
		Electrical Lifetime			10,000 Times	3	3
	AC1,2,3 Operating Frequency (per hour)	100 % load		Times	450	450	450
		50 % load (DC)			900	900	900
		20 % load (DC)			1,800	1,800	1,800
AC4 Operationg Frequency (per hour)	100 % load		Times	200	200	200	
	50 % load			400	400	400	
Making Capacity	220 V		A	750	850	1,000	
	440 V			750	850	1,000	
Breaking Capacity	220 V		A	600	680	800	
	440 V			600	680	800	
Mounting Method			Screw & DIN-Rail				
Contacts	Main	AC	1NO1NC or 2NO2NC				
		DC	2NO1NC				
		AC/DC	-				
	Auxilliary	AC	2NO2NC				
		DC	1NO1NC				
AC/DC		-					
Dimensions	AC	W x H x D	mm	70 x 146 x 153			
	DC			70 x 146 x 153			
	AC/DC			-			
Weight	AC		kg	1.3			
	DC			1.3			
	AC/DC			-			
Contact Arrangement							
Main	Main	3a					
	Auxilliary	2a2b					
Main + Auxilliary (2a2b)	Main	3a					
	Auxilliary	4a4b					

※ - Auxiliary Contacts Usage: Please refer to 48 - 49 page

- 1) Possible auxiliary contacts combination -> A Contact: maximum 6a, B Contact: maximum 4b
- 2) When using 4a4b by side auxillary block, front auxillary block is not applicable.
- 3) When using main 2a2b, front auxillary block is applicable.

Accessories

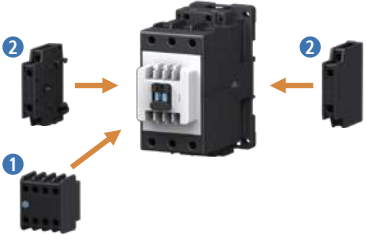
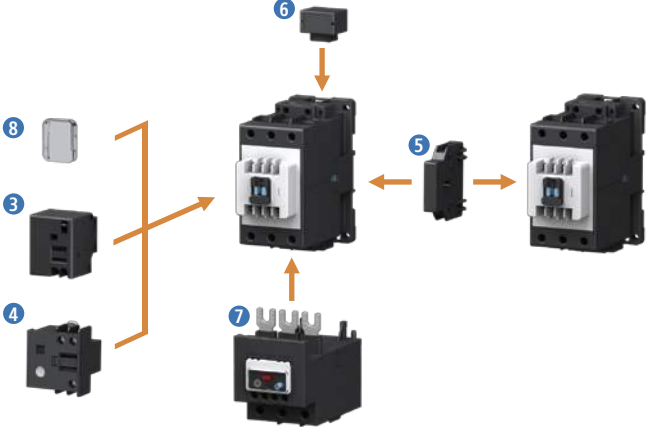
Auxilliary Contacts	Other Accessories	
		
<p>1 Auxilliary Contact Block (Front Mounting) HGC TB - 48 page</p> <p>2 Auxilliary Contact Block (Side Mounting) HGC SB 100 - 48 page</p>	<p>3 Mechanical Latching Block HGC LB 100 - 51 page</p> <p>4 Timer HGC ET - 53 page</p> <p>5 Mechanical Interlock Block HGC IU 100 - 50 page</p>	<p>6 Surge Absorber HGC RC/CD100 - 52 page</p> <p>7 Thermal Overload Relay HGT 100 - 38 page</p> <p>8 Front Safety Cover HGFC 100 - 55 page</p>

Order Information

• Standard Order (w/protection cover, w/o accessories) / Auxiliary Contacts: 2NO2NC

Operation Voltage (V)		HGC75	HGC85	HG100
AC (60 Hz)	24	HGC75 22NS A24	HGC85 22NS A24	HGC100 22NS A24
	48	HGC75 22NS A48	HGC85 22NS A48	HGC100 22NS A48
	110	HGC75 22NS A110	HGC85 22NS A110	HGC100 22NS A110
	120	HGC75 22NS A120	HGC85 22NS A120	HGC100 22NS A120
	220	HGC75 22NS A220	HGC85 22NS A220	HGC100 22NS A220
	240	HGC75 22NS A240	HGC85 22NS A240	HGC100 22NS A240
	380	HGC75 22NS A380	HGC85 22NS A380	HGC100 22NS A380
	440	HGC75 22NS A440	HGC85 22NS A440	HGC100 22NS A440
AC (50 Hz)	24	HGC75 22NS X24	HGC85 22NS X24	HGC100 22NS X24
	48	HGC75 22NS X48	HGC85 22NS X48	HGC100 22NS X48
	110	HGC75 22NS X110	HGC85 22NS X110	HGC100 22NS X110
	120	HGC75 22NS X120	HGC85 22NS X120	HGC100 22NS X120
	220	HGC75 22NS X220	HGC85 22NS X220	HGC100 22NS X220
	240	HGC75 22NS X240	HGC85 22NS X240	HGC100 22NS X240
	380	HGC75 22NS X380	HGC85 22NS X380	HGC100 22NS X380
	440	HGC75 22NS X440	HGC85 22NS X440	HGC100 22NS X440
DC	24	HGC75 21NS D24	HGC85 21NS D24	HGC100 21NS D24
	48	HGC75 21NS D48	HGC85 21NS D48	HGC100 21NS D48
	110	HGC75 21NS D110	HGC85 21NS D110	HGC100 21NS D110
	125	HGC75 21NS D125	HGC85 21NS D125	HGC100 21NS D125
	220	HGC75 21NS D220	HGC85 21NS D220	HGC100 21NS D220

Rating and Selection

Magnetic Contactor: HGC 115 - 150 A

Rating



Model				HGC115	HGC130	HGC150	
IEC 60947-4	Rated Insulation Voltage [U _i]		V	1,000	1,000	1,000	
	Rated Operational Voltage [U _e]		V	1,000	1,000	1,000	
	Rated Impulse Withstand Voltage [U _{imp}]		kV	8	8	8	
	Rated Thermal Current [I _{th}] (AC1)		A	160	180	210	
	AC3	200 - 240 V		kW/A	37/115	40/130	45/150
		380 - 440 V			60/115	65/130	75/150
		500 - 550 V			59/100	70/120	90/140
		660 - 690 V			55/65	75/82	90/120
		1,000 V			65/50	75/54	90/66
		Lifetime	Electrical		10,000 Times	100	100
	Mechanical		500	500		500	
	AC4	200 - 240 V		kW/A	19/80	22/93	30/125
		380 - 440 V			37/75	45/90	55/110
		Electrical Lifetime			10,000 Times	3	3
	AC1,2,3 Operating Frequency (per hour)	100 % load		Times	450	450	450
		50 % load (DC)			900	900	900
		20 % load (DC)			1,800	1,800	1,800
	AC4 Operatiog Frequency (per hour)	100 % load		Times	200	200	200
50 % load		400	400		400		
Making Capacity	220 V		A	1,150	1,300	1,500	
	440 V			1,150	1,300	1,500	
Breaking Capacity	220 V		A	920	1,040	1,200	
	440 V			920	1,040	1,200	
Mounting Method				Screw			
Contacts	Main	AC/DC		2NO2NC			
	Auxilliary ¹⁾	AC/DC		2NO2NC			
Dimensions	AC/DC	W x H x D	mm	103 x 155 x 145.1			
Weight	AC/DC		kg	2.7			
Contact Arrangement							
Main	Main	3a					
	Auxilliary	2a2b					
Main + Auxilliary (2a2b)	Main	3a					
	Auxilliary	4a4b					

※ - Auxilliary Contacts Usage: Please refer to page 48 - 49.

¹⁾ Maximum number of side auxilliary contacts

Accessories

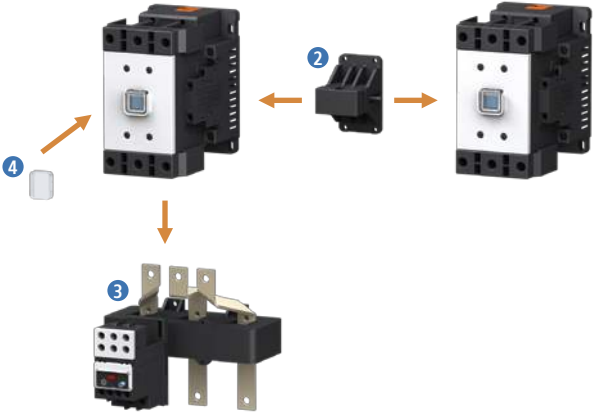
Auxiliary Contacts	Other Accessories
	
<p>1 Auxilliary Contact Block (Side mounting) HGC SB 800 - 48 page</p>	<p>2 Mechanical Interlock Block HGC IU 265 - 50 page</p> <p>3 Thermal Overload Relay HGT 150 - 40 page</p> <p>4 Front Safety Cover HGCFC 150 - 55 page</p>

Order Information

• Standard Order (w/protection cover, w/o accessories) / Auxiliary Contacts: 2NO2NC

Voltage (V)	Voltage Band (V)	HGC115	HGC130	HGC150
24	AC24 - 26 DC24	HGC115 22NS F24	HGC130 22NS F24	HGC150 22NS F24
48	AC44 - 52 DC48	HGC115 22NS F48	HGC130 22NS F48	HGC150 22NS F48
220	AC100 - 240 DC110 - 220	HGC115 22NS F220	HGC130 22NS F220	HGC150 22NS F220
440	AC380 - 450	HGC115 22NS F440	HGC130 22NS F440	HGC150 22NS F440

Rating and Selection

Magnetic Contactor: HGC 185 - 265 A

Rating



Model		HGC185	HGC225	HGC265		
IEC 60947	Rated Insulation Voltage [U _i]	V	1,000	1,000	1,000	
	Rated Operational Voltage [U _e]	V	1,000	1,000	1,000	
	Rated Impulse Withstand Voltage [U _{imp}]	kV	8	8	8	
	Rated Thermal Current [I _{th}] (AC1)	A	275	315	350	
	AC3	200 - 240 V	kW/A	55/185	75/225	80/265
		380 - 440 V		90/185	132/225	147/265
		500 - 550 V		110/180	132/200	150/225
		660 - 690 V		110/120	132/150	160/173
		1,000 V		110/78	132/96	160/113
	Lifetime	Electrical	10,000 Times	100	100	100
				Mechanical	500	500
	AC4	200 - 240 V	kW/A	37/150	45/185	50/200
		380 - 440 V		75/150	90/185	102/200
		Electrical Lifetime	10,000 Times	3	3	3
	AC1,2,3 Operating Frequency (per hour)	100 % load	Times	300	300	300
		50 % load (DC)		600	600	600
		20 % load (DC)		1,200	1,200	1,200
	AC4 Operatiog Frequency (per hour)	100 % load	Times	200	200	200
50 % load		400		400	400	
Making Capacity	220 V	A	1,850	2,250	2,650	
	440 V		1,850	2,250	2,650	
Breaking Capacity	220 V	A	1,480	1,800	2,120	
	440 V		1,480	1,800	2,120	
Mounting Method		Screw				
Contacts	Main	AC/DC	2NO2NC			
	Auxilliary ¹⁾	AC/DC	2NO2NC			
Dimensions	AC/DC	W x H x D	mm			
Weight	AC/DC	kg	138 x 204 x 174.2			
Contact Arrangement						
Main	Main	3a				
	Auxilliary	2a2b				
Main + Auxilliary (2a2b)	Main	3a				
	Auxilliary	4a4b				

※ - Auxilliary Contacts Usage: Please refer to page 48 - 49.

¹⁾ Maximum number of side auxilliary contacts.

Accessories

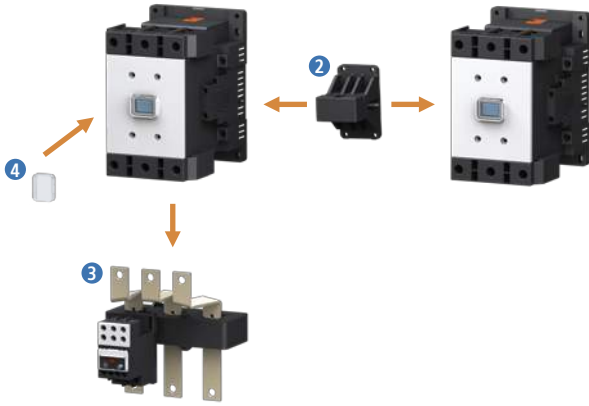
Auxiliary Contacts	Other Accessories
	
<p>① Auxiliary Contact Block (Side Mounting) HGC SB 800 - 48 page</p>	<p>② Mechanical Interlock Block HGC IU 265 - 50 page</p> <p>③ Thermal Overload Relay HGT 265 - 40 page</p> <p>④ Front Safety Cover HGCFC265 - 55 page</p>

Order Information

• Standard Order (w/protection cover, w/o accessories) / Auxiliary Contacts: 2NO2NC

Voltage (V)	Voltage Band (V)	HGC185	HGC225	HGC265
24	AC24 - 26 DC24	HGC185 22NS F24	HGC225 22NS F24	HGC265 22NS F24
48	AC44 - 52 DC48	HGC185 22NS F48	HGC225 22NS F48	HGC265 22NS F48
220	AC100 - 240 DC110 - 220	HGC185 22NS F220	HGC225 22NS F220	HGC265 22NS F220
440	AC380 - 450	HGC185 22NS F440	HGC225 22NS F440	HGC265 22NS F440

Rating and Selection

Magnetic Contactor: HGC 300 - 500 A

Rating



Model				HGC300	HGC400	HGC500	
IEC 60947-4	Rated Insulation Voltage [U _i]		V	1,000	1,000	1,000	
	Rated Operational Voltage [U _e]		V	1,000	1,000	1,000	
	Rated Impulse Withstand Voltage [U _{imp}]		kV	8	8	8	
	Rated Thermal Current [I _{th}] (AC1)		A	400	500	550	
	AC3	200 - 240 V		kW/A	90/300	125/400	140/500
		380 - 440 V			160/300	220/400	250/500
		500 - 550 V			200/273	250/300	300/426
		660 - 690 V			200/220	250/300	335/360
		1,000 V			200/141	250/178	275/192
	Lifetime	Electrical	10,000 Times	100	100	50	
		Mechanical		500	500	500	
	AC4	200 - 240 V		kW/A	55/220	75/300	90/350
		380 - 440 V			110/220	150/300	175/350
		Electrical Lifetime		10,000 Times	3	3	3
	AC1,2,3 Operating Frequency (per hour)	100 % load		Times	300	300	300
		50 % load (DC)			600	600	600
		20 % load (DC)			1,200	1,200	1,200
	AC4 Operatiog Frequency (per hour)	100 % load		Times	150	150	150
50 % load		300	300		300		
Making Capacity	220 V		A	3,000	4,000	5,000	
	440 V			3,000	4,000	5,000	
Breaking Capacity	220 V		A	2,400	3,200	4,000	
	440 V			2,400	3,200	4,000	
Mounting Method				Screw			
Contacts	Main	AC/DC		2NO2NC			
	Auxilliary ¹⁾	AC/DC		2NO2NC			
Dimensions	AC/DC	W x H x D	mm	163 x 243 x 203			
Weight	AC/DC		kg	9.2			
Contact Arrangement							
Main	Main	3a					
	Auxilliary	2a2b					
Main + Auxilliary (2a2b)	Main	3a					
	Auxilliary	4a4b					

※ - Auxilliary Contacts Usage: Please refer to page 48 - 49.

¹⁾ Maximum number of side auxilliary contacts.

Accessories

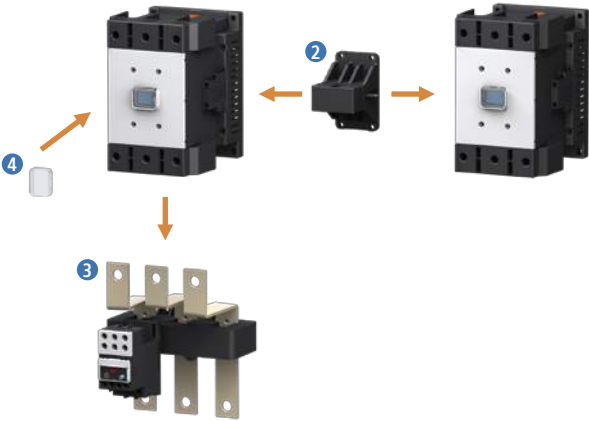
Auxiliary Contacts	Other Accessories
	
<p>① Auxiliary Contact Block (Side Mounting) HGC SB 800 - 48 page</p>	<p>② Mechanical Interlock Block HGC IU 800 - 50 page</p> <p>③ Thermal Overload Relay HGT 500 - 40 page</p> <p>④ Front Safety Cover HGCFC 500 - 55 page</p>

Order Information

• Standard Order (w/protection cover, w/o accessories) / Auxiliary Contacts: 2NO2NC

Voltage (V)	Voltage Band (V)	HGC300	HGC400	HGC500
220	AC100 - 240 DC110 - 220	HGC300 22NS F220	HGC400 22NS F220	HGC500 22NS F220
440	AC380 - 450	HGC300 22NS F440	HGC400 22NS F440	HGC500 22NS F440

Rating and Selection

Magnetic Contactor: HGC 630 - 800 A

Rating



Model				HGC630	HGC800	
IEC 60947-4	Rated Insulation Voltage [U _i]		V	1,000	1,000	
	Rated Operational Voltage [U _e]		V	1,000	1,000	
	Rated Impulse Withstand Voltage [U _{imp}]		kV	8	8	
	Rated Thermal Current [I _{th}] (AC1)		A	750	900	
	AC3	200 - 240 V		kW/A	190/630	220/800
		380 - 440 V			330/630	440/800
		500 - 550 V			330/500	500/720
		660 - 690 V			400/412	500/630
		1,000 V			300/213	400/284
	Lifetime	Electrical	10,000	50	50	
				Mechanical	500	500
	AC4	200 - 240 V		kW/A	110/400	160/630
		380 - 440 V			200/400	300/630
		Electrical Lifetime			10,000	3
	AC1,2,3 Operating Frequency (per hour)	100 % load		Times	300	300
		50 % load (DC)			600	600
20 % load (DC)		1,200	1,200			
AC4 Operationg Frequency (per hour)	100 % load		Times	150	150	
	50 % load			300	300	
Making Capacity	220 V		A	6,300	8,000	
	440 V			6,300	8,000	
Breaking Capacity	220 V		A	5,040	6,400	
	440 V			5,040	6,400	
Mounting Method				Screw		
Contacts	Main	AC/DC		2NO2NC		
	Auxilliary ¹⁾	AC/DC		2NO2NC		
Dimensions	AC/DC	W x H x D	mm	276 x 314 x 255.3		
Weight	AC/DC		kg	25		
Contact Arrangement						
Main	Main	3a				
	Auxilliary	2a2b				
Main + Auxilliary (2a2b)	Main	3a				
	Auxilliary	4a4b				

※ - Auxilliary Contacts Usage: Please refer to page 48 - 49.

¹⁾ Maximum number of side auxilliary contacts.

Accessories

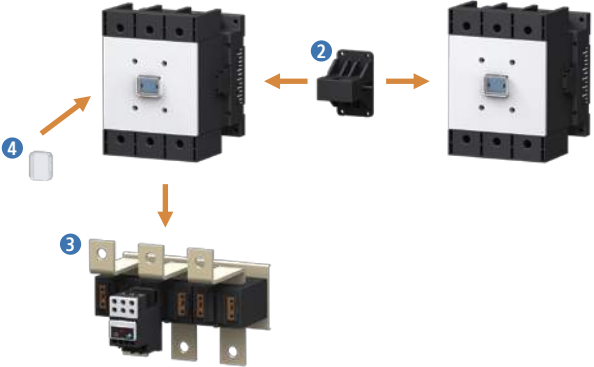
Auxiliary Contacts	Other Accessories
	
<p>① Auxiliary Contact Block (Side Mounting) HGC SB 800 - 48 page</p>	<p>② Mechanical Interlock Block HGC IU 800 - 50 page</p> <p>③ Thermal Overload Relay HGT 800 - 40 page</p> <p>④ Front Safety Cover HGCFC 800 - 55 page</p>

Order Information

• Standard Order (w/protection cover, w/o accessories) / Auxiliary Contacts: 2NO2NC

Voltage (V)	Voltage Band (V)	HGC630	HGC800
110	AC100 - 127 DC100 - 110	HGC630 22NS F110	HGC800 22NS F110
220	AC200 - 240 DC200 - 220	HGC630 22NS F220	HGC800 22NS F220
440	AC380 - 450	HGC630 22NS F440	HGC800 22NS F440

Rating and Selection

Thermal Overload Relay (TOR)



Exterior and Model		Rating							
Exterior	Model	Current (A)				Applicable Cable Size (mm ²)		Auxiliary Contact	Applicable Contactor
		Nominal Current	Setting Current			Main Circuit	Auxilliary Circuit		
			Min.	Mid.	Max.				
 <p>(W x H x D) 45 × 82.7 × 78.2 mm 0.12 kg</p>	HGT18	0.18	0.12	0.15	0.18	1 - 25	1 - 25	1NO1NC	HGC9 HGC12 HGC18
		0.26	0.18	0.22	0.26				
		0.35	0.25	0.3	0.35				
		0.5	0.34	0.42	0.5				
		0.7	0.5	0.6	0.7				
		0.9	0.6	0.75	0.9				
		1.2	0.8	1	1.2				
		1.6	1.1	1.35	1.6				
		2.1	1.5	1.8	2.1				
		3	2	2.5	3				
		4.2	2.8	3.5	4.2				
		5	3	4	5				
		6	4	5	6				
		8	5.6	6.8	8				
		9	6	7.5	9				
		12	8	10	12				
18	12	15	18						

Code		Accessories Mounting Adapter	Notes
Thermal Overload Relay (Protection Class 10 A)			Installation Method
Screw Type Terminal (W/Terminal Cover)			
K-Type (3 phase, 3 elements)	H-Type (3 phase, 2 elements)		Method 1. Connect TOR to MC directly. Method 2. TOR is installed individually using Mounting Adaptor.
HGT18K A0P18S	HGT18H A0P18S	HGTMB18	 <p>Mounting Adapter HGTMB18 0.08 kg</p> <p>Connect to Contactor Directly</p> <p>Mounting Adapter (Screw & DIN-Rail)</p>
HGT18K A0P26S	HGT18H A0P26S		
HGT18K A0P35S	HGT18H A0P35S		
HGT18K A0P50S	HGT18H A0P50S		
HGT18K A0P70S	HGT18H A0P70S		
HGT18K A0P90S	HGT18H A0P90S		
HGT18K A1P20S	HGT18H A1P20S		
HGT18K A1P60S	HGT18H A1P60S		
HGT18K A2P10S	HGT18H A2P10S		
HGT18K A0003S	HGT18H A0003S		
HGT18K A4P20S	HGT18H A4P20S		
HGT18K A0005S	HGT18H A0005S		
HGT18K A0006S	HGT18H A0006S		
HGT18K A0008S	HGT18H A0008S		
HGT18K A0009S	HGT18H A0009S		
HGT18K A0012S	HGT18H A0012S		
HGT18K A0018S	HGT18H A0018S		

Rating and Selection





Thermal Overload Relay (TOR)

Exterior and Model		Rating							
Exterior	Model	Current (A)				Applicable Cable Size (mm ²)		Auxiliary Contact	Applicable Contactor
		Nominal Current	Setting Current			Main Circuit	Auxiliary Circuit		
			Min.	Mid.	Max.				
 (W x H x D) 45 × 95.5 × 69.4 mm 0.16kg	HGT40	10	7	8.5	10	2 - 10	1 - 2.5	1NO1NC	HGC25 HGC32 HGC40
		12	8	10	12				
		18	12	15	18				
		22	15	18.5	22				
		25	17	21	25				
		32	22	27	32				
		40	28	34	40				
 (W x H x D) 55 × 110.7 × 89.3 mm 0.29 kg	HGT65	10	7	8.5	10	2 - 25	1 - 2.5	1NO1NC	HGC50 HGC65
		12	8	10	12				
		18	12	15	18				
		22	15	18.5	22				
		25	17	21	25				
		32	22	27	32				
		40	28	34	40				
		50	34	42	50				
		65	45	55	65				
 (W x H x D) 70 × 128.1 × 105 mm 0.47 kg	HGT100	25	17	21	25	6 - 38	1 - 2.5	1NO1NC	HGC75 HGC85 HGC100
		32	22	27	32				
		40	28	34	40				
		50	34	42	50				
		65	45	55	65				
		75	52	63	75				
		85	59	72	85				
		100	70	85	100				

Code			Notes	
Thermal Overload Relay (Characteristics Class 10A)			Installation Method Method 1. Connect TOR with MC directly. Method 2. TOR is installed individually using Mounting Adapter.	
Screw Type Terminal (W/Terminal Cover)		Lug Type Terminal		Accessories Mounting Adapter
K-Type (3 phase, 3 elements)	H-Type (3 phase, 2 elements)	K-Type (3 phase, 3 elements)		
HGT40K A0010S	HGT40H A0010S		HGTM B40  <p>Mounting Adapter HGTM B40 (0.10 kg) HGTM B65 (0.12 kg) HGTM B100 (0.2 kg)</p>	
HGT40K A0012S	HGT40H A0012S			
HGT40K A0018S	HGT40H A0018S			
HGT40K A0022S	HGT40H A0022S			
HGT40K A0025S	HGT40H A0025S			
HGT40K A0032S	HGT40H A0032S			
HGT40K A0040S	HGT40H A0040S			
HGT65K A0010S	HGT65H A0010S	HGT65K A0010C	HGTM B65  <p>Connect to Contactor Directly</p> <p>Mounting Adapter (Screw & DIN-Rail)</p>	
HGT65K A0012S	HGT65H A0012S	HGT65K A0012C		
HGT65K A0018S	HGT65H A0018S	HGT65K A0018C		
HGT65K A0022S	HGT65H A0022S	HGT65K A0022C		
HGT65K A0025S	HGT65H A0025S	HGT65K A0025C		
HGT65K A0032S	HGT65H A0032S	HGT65K A0032C		
HGT65K A0040S	HGT65H A0040S	HGT65K A0040C		
HGT65K A0050S	HGT65H A0050S	HGT65K A0050C		
HGT65K A0065S	HGT65H A0065S	HGT65K A0065C		
HGT100K A0025S	HGT100H A0025S	HGT100K A0025C		HGTM B100  <p>Lug Type</p> <p>Lug Terminal</p>
HGT100K A0032S	HGT100H A0032S	HGT100K A0032C		
HGT100K A0040S	HGT100H A0040S	HGT100K A0040C		
HGT100K A0050S	HGT100H A0050S	HGT100K A0050C		
HGT100K A0065S	HGT100H A0065S	HGT100K A0065C		
HGT100K A0075S	HGT100H A0075S	HGT100K A0075C		
HGT100K A0085S	HGT100H A0085S	HGT100K A0085C		
HGT100K A00100S	HGT100H A00100S	HGT100K A00100C		

Rating and Selection

Thermal Overload Relay (TOR)

Exterior and Model		Rating							
Exterior	Model	Current (A)					Applicable Cable (mm ²)	Auxiliary Contact	Applicable Contactor
		Nominal Current	Setting Current			CT Ratio			
			Min.	Mid.	Max.				
 <p>(W x H x D) 180 x 179.3 x 159 mm 2.0 kg</p>	HGT150	80	48	64	80	80 : 5	1 - 2.5	1NO1NC	HGC115 HGC130 HGC150
		115	69	92	115	115 : 5			
		130	78	104	130	130 : 5			
		150	90	120	150	150 : 5			
 <p>(W x H x D) 180 x 179.3 x 185mm 2.2 kg</p>	HGT265	80	48	64	80	80 : 5	1 - 2.5	1NO1NC	HGC185 HGC225 HGC265
		115	69	92	115	115 : 5			
		130	78	104	130	130 : 5			
		150	90	120	150	150 : 5			
		185	111	148	185	185 : 5			
		225	135	180	225	225 : 5			
 <p>(W x H x D) 180 x 179.3 x 205.2 mm 2.4 kg</p>	HGT500	150	90	120	150	150 : 5	1 - 2.5	1NO1NC	HGC300 HGC400 HGC500
		185	111	148	185	185 : 5			
		225	135	180	225	225 : 5			
		265	159	212	265	265 : 5			
		300	180	240	300	300 : 5			
		400	240	320	400	400 : 5			
		500	300	400	500	500 : 5			
 <p>(W x H x D) 245 x 209.9 x 197 mm 6.2 kg</p>	HGT800	630	378	504	630	630 : 5	1 - 2.5	1NO1NC	HGC630 HGC800
		800	480	640	800	800 : 5			

Code		Notes	
Thermal Overload Relay (Characteristics Class 10 A)		Installation Method	
Screw Type Terminal (W/Terminal Cover)		Method 1.Connect CT with MC directly.	
K-Type (3 phase, 3 elements)	H-Type (3 phase, 2 elements)		
HGT150K A0080S	HGT150H A0080S		
HGT150K A0115S	HGT150H A0115S	HGC115 HGC130 HGC150	HGC185 HGC225 HGC265
HGT150K A0130S	HGT150H A0130S		
HGT150K A0150S	HGT150H A0150S		
HGT265K A0080S	HGT265H A0080S		
HGT265K A0115S	HGT265H A0115S		
HGT265K A0130S	HGT265H A0130S		
HGT265K A0150S	HGT265H A0150S		
HGT265K A0185S	HGT265H A0185S		
HGT265K A0225S	HGT265H A0225S		
HGT265K A0265S	HGT265H A0265S		
HGT400K A0150S	HGT400H A0150S	HGC300 HGC400 HGC500	HGC630 HGC800
HGT400K A0185S	HGT400H A0185S		
HGT400K A0225S	HGT400H A0225S		
HGT400K A0265S	HGT400H A0265S		
HGT400K A0300S	HGT400H A0300S		
HGT400K A0400S	HGT400H A0400S		
HGT500K A0500S	HGT500H A0500S		
HGT800K A0630S	HGT800H A0630S		
HGT800K A0800S	HGT800H A0800S		

Ratings and Ordering Code

Control Relay (HGR)

Rating



Model				HGR-X (AC)		HGR-P (DC)	
						Permanent Magnetic	
Rated Insulation		IEC 60947		V		AC750	
Voltage [U _i]		VDE0660		V		AC1,000	
Rated Thermal Current [I _{th}] (AC1)		A				16	
Rated Current [I _e]	AC15	220 V		A			4
		380 V			3		
		440 V			3		
		500 V			2		
		690 V			2		
	DC12 (Resistive Load)	24 V			4		
		48 V			2.5		
		125 V			1.1		
		250 V			0.3		
	DC13 (Coil Load)	24 V			4		
		48 V			2.5		
		125 V			1.1		
		250 V			0.3		
	UL/CSA 1)	AC120 V			6		
AC240 V		3					
DC125 V		1.1					
DC250 V		0.3					
Mechanical Lifetime		X 10,000		1,500		1,000	
Cable Size		mm ²				2 x 0.75-2.5	
Operating Frequency (per hour)		Times		3,000		1,800	
Maximum Fuse Rating	Plug-fuse (Fast/Slow)		A			35/25	
	MCB (C curve)			16			
	HRC fuse (DIN/BS88)			25			
Mounting Method				Screw & DIN-Rail			
Auxiliary Contacts				4NC			
				1NO + 3NC			
				2NO + 2NC			
				3NO + 1NC			
				4NO			
Coil Power Consumption	A/C (60Hz)	Inrush	VAW	80/64			-
		Hold		8/2.5			-
	D/C	Inrush/Hold	W	-			5
Dimensions	A/C	W x H x D	mm	44 x 75 x 80			
	D/C			-		44 x 75 x 93.8	
W	A/C	kg		0.3			
	D/C			-		0.45	

※ 1) Contact Rating Code: A300 - P150

※ Please be careful in wiring of coil terminal +,- polarity with HGR-P model.

Operation Features

Model		HGR (AC220 V, 60 Hz)				HGR-P			
		22	40	44	80	22	40	44	80
Operation Voltage (V)	Making	120 - 170	120 - 170	120 - 170	120 - 170	65 - 70	70 - 75	65 - 70	75 - 80
	Breaking	70 - 110	70 - 110	70 - 110	70 - 110	12 - 15	15 - 18	12 - 15	15 - 20
Operation Time (msec)	Coil On→No Contact On	15 - 25	15 - 25	15 - 25	15 - 25	45 - 55	65 - 75	50 - 60	65 - 75
	Coil On→NC Contact Off	10 - 25		10 - 25		40 - 50		40 - 50	
	Coil Off→NO Contact Off	5 - 25	5 - 25	5 - 25	5 - 25	20 - 30	10 - 20	20 - 30	10 - 20
	Coil Off→NC Contact On	10 - 25		10 - 25		25 - 35		25 - 35	

Order Information

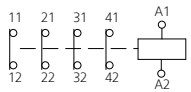
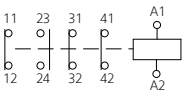
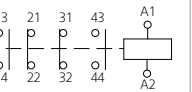
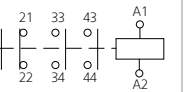
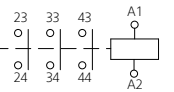
Operation Voltage (V)	Contacts Combination					
	4NC	1NO + 3NC	2NO + 2NC	3NO + 1NC	4NO	
AC60 Hz	24	HGR 04XS A24	HGR 13XS A24	HGR 22XS A24	HGR 31XS A24	HGR 40XS A24
	48	HGR 04XS A48	HGR 13XS A48	HGR 22XS A48	HGR 31XS A48	HGR 40XS A48
	110	HGR 04XS A110	HGR 13XS A110	HGR 22XS A110	HGR 31XS A110	HGR 40XS A110
	120	HGR 04XS A120	HGR 13XS A120	HGR 22XS A120	HGR 31XS A120	HGR 40XS A120
	208	HGR 04XS A208	HGR 13XS A208	HGR 22XS A208	HGR 31XS A208	HGR 40XS A208
	220	HGR 04XS A220	HGR 13XS A220	HGR 22XS A220	HGR 31XS A220	HGR 40XS A220
	240	HGR 04XS A240	HGR 13XS A240	HGR 22XS A240	HGR 31XS A240	HGR 40XS A240
	380	HGR 04XS A380	HGR 13XS A380	HGR 22XS A380	HGR 31XS A380	HGR 40XS A380
	440	HGR 04XS A440	HGR 13XS A440	HGR 22XS A440	HGR 31XS A440	HGR 40XS A440
	480	HGR 04XS A480	HGR 13XS A480	HGR 22XS A480	HGR 31XS A480	HGR 40XS A480
	600	HGR 04XS A600	HGR 13XS A600	HGR 22XS A600	HGR 31XS A600	HGR 40XS A600
AC50 Hz	24	HGR 04XS X24	HGR 13XS X24	HGR 22XS X24	HGR 31XS X24	HGR 40XS X24
	42	HGR 04XS X42	HGR 13XS X42	HGR 22XS X42	HGR 31XS X42	HGR 40XS X42
	48	HGR 04XS X48	HGR 13XS X48	HGR 22XS X48	HGR 31XS X48	HGR 40XS X48
	100	HGR 04XS X100	HGR 13XS X100	HGR 22XS X100	HGR 31XS X100	HGR 40XS X100
	110	HGR 04XS X110	HGR 13XS X110	HGR 22XS X110	HGR 31XS X110	HGR 40XS X110
	220	HGR 04XS X220	HGR 13XS X220	HGR 22XS X220	HGR 31XS X220	HGR 40XS X220
	240	HGR 04XS X240	HGR 13XS X240	HGR 22XS X240	HGR 31XS X240	HGR 40XS X240
	380	HGR 04XS X380	HGR 13XS X380	HGR 22XS X380	HGR 31XS X380	HGR 40XS X380
	400	HGR 04XS X400	HGR 13XS X400	HGR 22XS X400	HGR 31XS X400	HGR 40XS X400
	440	HGR 04XS X440	HGR 13XS X440	HGR 22XS X440	HGR 31XS X440	HGR 40XS X440
	500	HGR 04XS X500	HGR 13XS X500	HGR 22XS X500	HGR 31XS X500	HGR 40XS X500
	550	HGR 04XS X550	HGR 13XS X550	HGR 22XS X550	HGR 31XS X550	HGR 40XS X550
DC Permanent Magnetic	24	HGR 04PS D24	HGR 13PS D24	HGR 22PS D24	HGR 31PS D24	HGR 40PS D24
	48	HGR 04PS D48	HGR 13PS D48	HGR 22PS D48	HGR 31PS D48	HGR 40PS D48
	110	HGR 04PS D110	HGR 13PS D110	HGR 22PS D110	HGR 31PS D110	HGR 40PS D110
	125	HGR 04PS D125	HGR 13PS D125	HGR 22PS D125	HGR 31PS D125	HGR 40PS D125
	200	HGR 04PS D200	HGR 13PS D200	HGR 22PS D200	HGR 31PS D200	HGR 40PS D200
	220	HGR 04PS D220	HGR 13PS D220	HGR 22PS D220	HGR 31PS D220	HGR 40PS D220
Contact Arrangement						

Accessories

- HGR has DC and AC types, and 5 types of possible contact configurations.
- HGR follows IEC 60947 and protection degree is IP20.
- Usable temperature range is -25 - 40 °C.
- HGR which has fast response time is appropriate for application of control circuit and factory automation.
- Applicable standard
IEC 60947-5-1, VDE0660, CENELEC-EN50011

Accessories



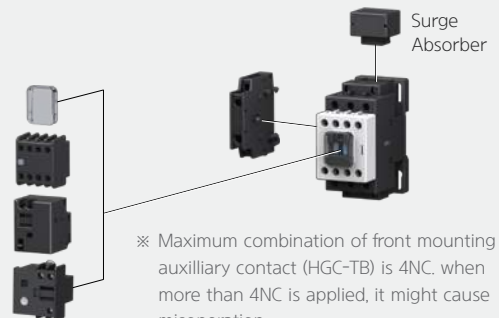

- Front Safety Cover
- Auxiliary Contact Block (Front Mounting)
- Mechanical Latching Block
- Electronic Timer



※ Maximum combination of front mounting auxiliary contact (HGC-TB) is 4NC. when more than 4NC is applied, it might cause misoperation.

Ratings and Ordering Code

Capacitor Switching Contactor

Products		Rating						Components	
Exterior	Model	Capacitor Capacity, kVAR (Appropriate Ambient Temperature 55 °C, 50 Hz/60 Hz)						Contactors	
		220 V	230/240 V	400/415 V	440 V	500/550 V	690 V	Model	Auxilliary Contacts
	HGC9C	5	5	9.7	9.7	14	14	HGC9	2NO + 2NC
	HGC12C	6.7	6.7	12.5	12.5	18	18	HGC12	2NO + 2NC
	HGC18C	8.5	8.5	16.7	16.7	24	24	HGC18	2NO + 2NC
	HGC25C	10	10	18	18	26	26	HGC25	2NO + 2NC
	HGC32C	14	16	27.5	30	34	45	HGC32	2NO + 2NC
	HGC40C	20	20	30	33.3	48	48	HGC40	2NO + 2NC
	HGC50C	21	24	40	45	50	65	HGC50	2NO + 2NC
	HGC65C	25	25	46	46	66	66	HGC65	2NO + 2NC
	HGC75C	30	30	54	54	78	78	HGC75	2NO + 2NC
	HGC85C	35	35	60	60	92	92	HGC85	2NO + 2NC
	HGC100C	50	50	80	80	100	100	HGC100	2NO + 2NC

Components		Order Information		Notes																		
Capacitor Unit		AC ¹⁾		Capacitor Switching Contactor																		
Model	Auxilliary Contacts	220 V, 60 Hz	220 V, 50 Hz																			
HGC CU40	1NO	HGC9C 32NS A220	HGC9C 32NS X220	 <ul style="list-style-type: none"> Capacitor switching contactor is combined with magnetic contactor Contactor is assembled with damping resistors which limit the high in-rush current when the capacitors are switched on. They are assembled with early-make contact block, which is switched on before the main contacts, thus, limiting the in-rush current. Capacitor switching unit is composed of 3 NO main contacts and 1 auxilliary contact (1NO or 1NC). When power is supplied, capacitor creates oscillation frequency (1~15KHZ) and generates transient current (over 180 In). Capacitor switching unit limits the transient current, thus, protects main contacts. When power is supplied to magnetic contactor, the value of maximum current is reduced as following cases. <ul style="list-style-type: none"> - Inductance of main power supply is too high. - Rating of line transformer is too low. - Short circuit of transformer is too high. <p>Making & Breaking Frequency and Lifetime</p> <table border="1"> <thead> <tr> <th colspan="2">Making & Breaking Frequency</th> <th>240 Cycles/h</th> </tr> </thead> <tbody> <tr> <td rowspan="2">Electrical Lifetime (AC-6b)</td> <td>Ue ≤ 440 Vac</td> <td>250,000</td> </tr> <tr> <td>500 Vac ≤ Ue ≤ 690 Vac</td> <td>100,000</td> </tr> </tbody> </table> <p>Order Information (Only Capacitor Unit)</p> <table border="1"> <thead> <tr> <th>Model</th> <th>Auxiliary Contact</th> <th>Order Information</th> <th>Notes</th> </tr> </thead> <tbody> <tr> <td rowspan="2">HGCCU40/100</td> <td>1NO</td> <td>HGCCU40/100 10N</td> <td rowspan="2">Damping resistors: 6 EA</td> </tr> <tr> <td>1NC</td> <td>HGCCU40/100 01N</td> </tr> </tbody> </table>	Making & Breaking Frequency		240 Cycles/h	Electrical Lifetime (AC-6b)	Ue ≤ 440 Vac	250,000	500 Vac ≤ Ue ≤ 690 Vac	100,000	Model	Auxiliary Contact	Order Information	Notes	HGCCU40/100	1NO	HGCCU40/100 10N	Damping resistors: 6 EA	1NC	HGCCU40/100 01N
	Making & Breaking Frequency		240 Cycles/h																			
Electrical Lifetime (AC-6b)	Ue ≤ 440 Vac	250,000																				
	500 Vac ≤ Ue ≤ 690 Vac	100,000																				
Model	Auxiliary Contact	Order Information	Notes																			
HGCCU40/100	1NO	HGCCU40/100 10N	Damping resistors: 6 EA																			
	1NC	HGCCU40/100 01N																				
HGC CU40	1NC	HGC9C 23NS A220	HGC9C 23NS X220																			
	1NO	HGC12C 32NS A220	HGC12C 32NS X220																			
HGC CU40	1NC	HGC12C 23NS A220	HGC12C 23NS X220																			
	1NO	HGC18C 32NS A220	HGC18C 32NS X220																			
HGC CU40	1NC	HGC18C 23NS A220	HGC18C 23NS X220																			
	1NO	HGC25C 32NS A220	HGC25C 32NS X220																			
HGC CU40	1NC	HGC25C 23NS A220	HGC25C 23NS X220																			
	1NO	HGC32C 32NS A220	HGC32C 32NS X220																			
HGC CU40	1NC	HGC32C 23NS A220	HGC32C 23NS X220																			
	1NO	HGC40C 32NS A220	HGC40C 32NS X220																			
HGC CU40	1NC	HGC40C 23NS A220	HGC40C 23NS X220																			
	1NO	HGC50C 32NS A220	HGC50C 32NS X220																			
HGC CU100	1NC	HGC50C 23NS A220	HGC50C 23NS X220																			
	1NO	HGC65C 32NS A220	HGC65C 32NS X220																			
HGC CU100	1NC	HGC65C 23NS A220	HGC65C 23NS X220																			
	1NO	HGC75C 32NS A220	HGC75C 32NS X220																			
HGC CU100	1NC	HGC75C 23NS A220	HGC75C 23NS X220																			
	1NO	HGC85C 32NS A220	HGC85C 32NS X220																			
HGC CU100	1NC	HGC85C 23NS A220	HGC85C 23NS X220																			
	1NO	HGC100C 32NS A220	HGC100C 32NS X220																			
HGC CU100	1NC	HGC100C 23NS A220	HGC100C 23NS X220																			

※ **1)** Operation Voltage

- 50 Hz: 24, 48, 110, 120, 220, 240, 380, 440 V - 60 Hz: 24, 48, 110, 120, 220, 240, 380, 440 V

Accessories

9 - 100 AF

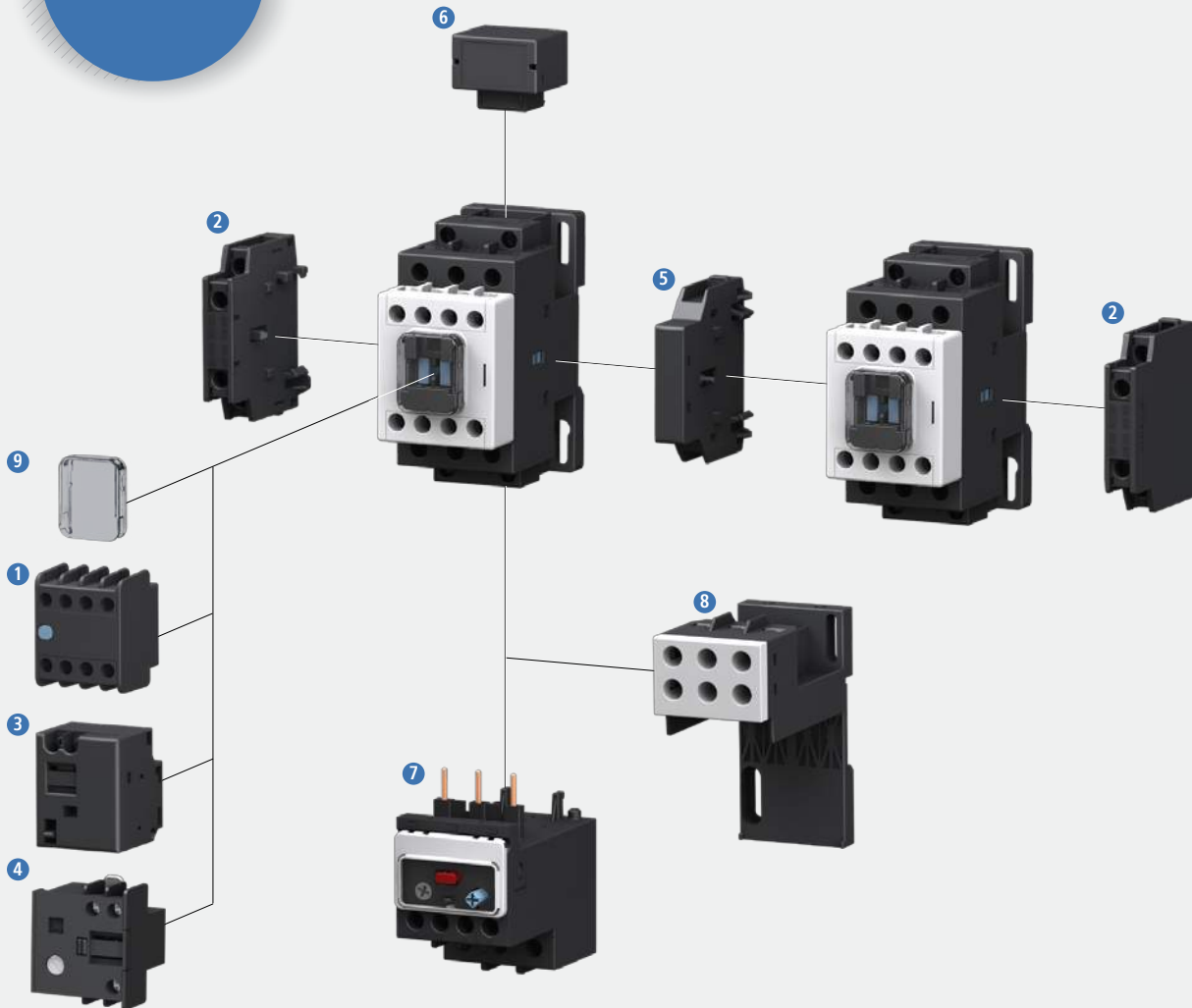

9 - 100 AF

- | | | |
|---|---|--|
| <p>1 Auxiliary Contact Block
(Front Side) HGC TB 48 page</p> | <p>4 Timer HGC ET
53 page</p> | <p>7 Thermal Overload Relay HGT
36 page</p> |
| <p>2 Auxiliary Contact Block
(Left/Right Side) HGC SB 48 page</p> | <p>5 Interlock Unit HGC IU
50 page</p> | <p>8 Separate Mounting Base HGTM
37, 39 page</p> |
| <p>3 Mechanical Latching Block
HGC LB 100 51 page</p> | <p>6 Surge Absorber HGC RC/CD
52 page</p> | <p>9 Front Safety Cover HGCF 100
55 page</p> |

115 - 800 AF

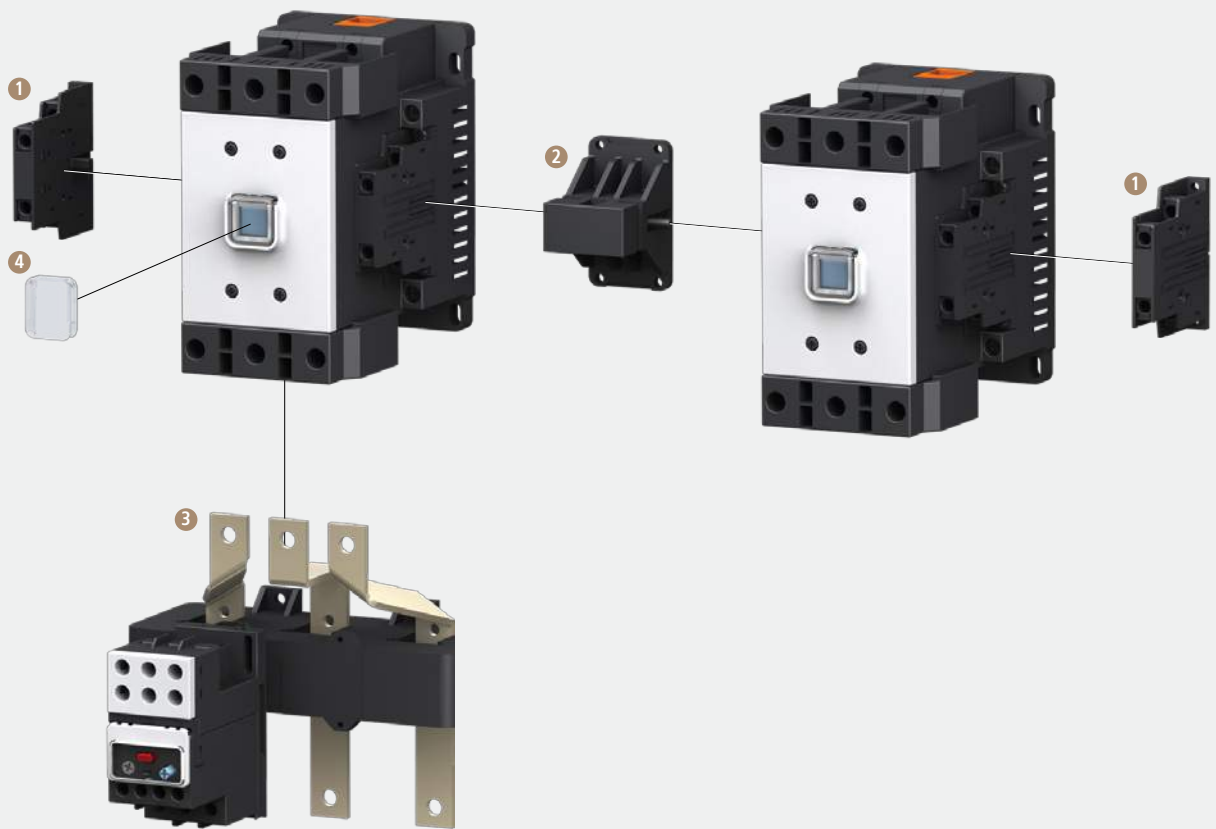

115 - 800 AF

① Auxiliary Contact Block HGC SB
48 page

② Interlock Unit HGC IU
50 page

③ Thermal Overload Relay HGT
40 page

④ Front Safety Cover HGCFC
55page

Accessories

Auxilliary Contact Block

Products		Rating					
Exterior	Model	Contacts Rating					
<p>Front</p> 	HG C TB	Rated Insulation Voltage (Ui)	IEC	AC690 V			
			UL	AC600 V			
		Rated Thermal Current (Ith)		16A			
		Operation Current AC15 (Coil Load)	120 V	6 A			
			240 V	4A			
			380 V	3 A			
			440 V	3 A			
			500 V	2 A			
			690 V	2 A			
		Operation Current DC13 (Coil Load)	24 V	4 A			
			48 V	2.5 A			
			125 V	1.1 A			
			250 V	0.3 A			
			480 V	0.2 A			
			600 V	0.2A			
<p>Side</p> 	HG C SB	Based on IEC 60947-4			Based on UL & CSA		
		Rated Insulation Voltage (Ui)		AC750 V		Thermal Current	
		Rated Thermal Current (Ith)		16 A		16 A	
		Operation Current AC12 (Resistive Load)	110 V	10 A	Operation Current (AC)	120 V	6 A
			220 V	8 A		240 V	3 A
			440 V	6 A		480 V	1.5 A
			690 V	2 A		600 V	1.2 A
			110 V	6 A		Operation Current (DC)	125 V
		220 V	4 A	250 V	0.55 A		
		440 V	3 A	440 V	0.2 A		
		690 V	2 A	600 V	0.2 A		
		Operation Current DC12 (Resistive Load)	24 V	4 A	※ Contact Rating Code: A600 - P300		
			48 V	2.5 A			
			125 V	1.1 A			
		Operation Current DC13 (Coil Load)	250 V	0.3 A			
24 V	4 A						
48 V	2.5 A						
Operation Current DC13 (Coil Load)	125 V	1.1 A					
	24 V	4 A					
	48 V	2.5 A					
Operation Current DC13 (Coil Load)	125 V	1.1 A					
	24 V	4 A					
	48 V	2.5 A					
Operation Current DC13 (Coil Load)	125 V	1.1 A					
	24 V	4 A					
	48 V	2.5 A					
Operation Current DC13 (Coil Load)	125 V	1.1 A					
	24 V	4 A					
	48 V	2.5 A					

Contacts Combination		Order Information		Notes	
Combination	Arrangement	W/Terminal Cover	Weight	Applicable Contactors	Install Method
2NC	<pre> 51 61 o o b b 52 62 </pre>	HGC TB02NS	0.031	HGC9 - 100 HGR	<p>Front Auxiliary Contacts</p> 
1NO + 1NC	<pre> 53 61 o o b o 54 62 </pre>	HGC TB11NS			
2NO	<pre> 53 63 o o o o 54 64 </pre>	HGC TB20NS			
4NC	<pre> 51 61 71 81 o o o o b b b b 52 62 72 82 </pre>	HGC TB04NS			
1NO + 3NC	<pre> 51 63 71 81 o o o o b o b b 52 64 72 82 </pre>	HGC TB13NS	0.053	<p>※ Maximum combination of b auxiliary contacts is 4NC.</p>	
2NO + 2NC	<pre> 53 61 71 83 o o o o o b b o 54 62 72 84 </pre>	HGC TB22NS			
3NO + 1NC	<pre> 53 61 73 83 o o o o o o o o 54 62 74 84 </pre>	HGC TB31NS			
4NO	<pre> 53 63 73 83 o o o o o o o o 54 64 74 84 </pre>	HGC TB40NS			
1NO + 1NC	<pre> 53/84 61/72 o o 54/83 62/71 </pre>	HGC SB40 11NS	0.028	HGC9 - 40	<p>Side Auxiliary Contacts</p>  <p>※ Maximum combination of b auxiliary contacts is 4NC.</p>
		HGC SB100 11NS	0.053	HGC50 - 100	
		HGC SB800 11NS	0.042	HGC115 - 800	

Accessories

Mechanical Interlock Unit

Mechanical interlock unit is a device provided to ensure that the magnetic contactor is engaged in during reverse operation. Mechanical interlock unit provides reliable interlocking between two contactors.

Rating and Selection

Code	Applicable Contactor	Weight (kg)
HGC IU40	HGC9 - 40	0.03
HGC IU100	HGC50 - 100	0.03
HGC IU265	HGC115 - 265	0.081
HGC IU800	HGC300 - 800	0.101



Wire Kit

Sets of power connections for reversing contactor.

Rating and Selection

Code	Applicable Contactor	Weight (kg)
HGC RB18	HGC9 - 18	0.2
HGC RB40	HGC25 - 32	0.2
HGC RB65	HGC40 - 65	0.3
HGC RB100	HGC75 - 100	0.5

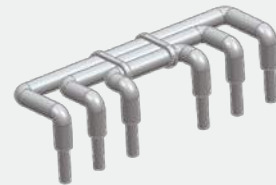

Handling

Mechanical interlock unit must not be installed vertically.

the Interlock should be connected via NC contacts for stable operation.

Please remove side auxiliary contact block first between contactors (HGC115 - 800), then install mechanical interlock unit.

Simultaneous closing by excessive force may cause damage.

Mechanical interlock unit is not applicable for DC type HGC40 - 100.



HGC9 - 100

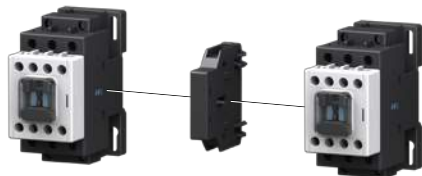

HGC115 - 800

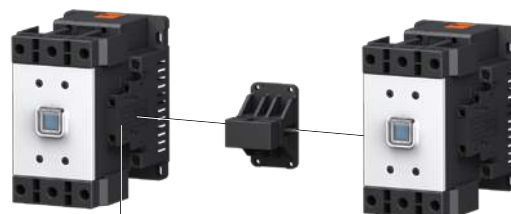

After disassembling side auxiliary contacts, install the mechanical interlock unit between contactors.

Mechanical Latching Block

Mechanical latching block keeps the contactor and control relay in the energized state even after a power failure.
Mechanical latching block which is designed as a module is easy to assemble with magnetic contactor or control relay.

Order Information

Model	Code	Current	Operation Voltage	Applicable Contactor
HGC LB100	HGC LB100 F024	AC/DC	24 V	HGC9 - 100 HGR
	HGC LB100 F048		48 V	
	HGC LB100 F110		100 - 125 V	
	HGC LB100 F220		200 - 240 V	
	HGC LB100 A440	AC	440 V	



Rating and Selection

Coil Power Consumption	VA	25
	W	20
Operation Voltage	V	$(0.85 - 1.1) \times U_c$
Operation Frequency	Cycle/h	1,200
Operation Voltage	AC	24, 48, 100 - 125, 200 - 240 V 440 V
	DC	24, 48, 100 - 125, 200 - 240 V
Mechanical Lifetime	X 10,000	50
Weight	kg	0.1



Handling

- Mechanical latching block starts to latch the contactor or control relay when it is energized, and keep latching during coil voltage drop-out of contactor or control relay.
- To Turn OFF
 - Manual: Push up the lever to "O" position.
 - Electrical: Supply power to the mechanical latching block.
: The power should be OFF before supplying power to the latching block.
- To Turn ON
 - By pushing "I", located in the center of latching block, latching block can start to latch without the energized coil.
- Caution
 - Contactor (or control relay) and mechanical latching block should not be used at the same time to supply control power.
 - Mechanical latching block must not receive control power for more than 1 second.
 - Please refer to the circuit diagram on the right.

Circuit Diagram

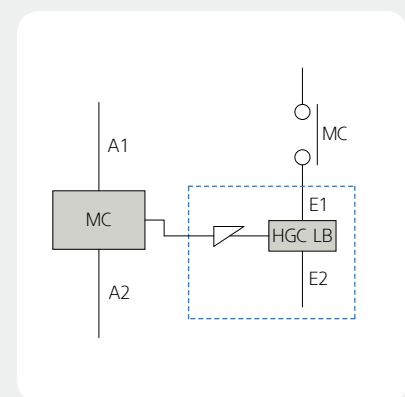

※ A1/A2: Coil Terminal,
E1/E2: Latching Block Terminal

Accessories

Surge Absorber

Surge Absorber (RC-Unit)

- Surge voltage occurs during the operation of contactor or control relay, and it is normally 10 - 20 times of rated voltage. Surge absorber drops the surge voltage less than 3 times of rated voltage.
- Surge absorber is required on accurate control circuit, especially for PLC circuit.
- Surge absorber prevents electronic components from high surge voltage damage.
- Surge absorber is applicable for both 50 Hz and 60 Hz. (for RC-Unit only)



Rating and Selection

Product	Code	Operation Voltage	Applicable Contactor	Weight (kg)
RC-Unit	HGC RC40 Y048	AC24 - 48 V	HGC9 - 32, HGR	0.029
	HGC RC40 Y220	AC110 - 220 V		
	HGC RC40 Y380	AC240 - 380 V		
	HGC RC100 Y048	AC24 - 48 V	HGC40 - 100	
	HGC RC100 Y220	AC110 - 220 V		
	HGC RC100 Y380	AC240 - 380 V		

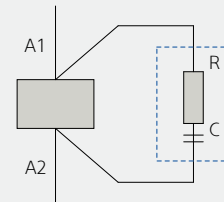

Clamping Diode

- Clamping diode is used for the purpose of preventing counter electromotive force on DC power supply.
- Clamping diode has to be installed when coil is connected in parallel.
- Clamping diode prevents electronic components from burning by counter electromotive force.



Rating and Selection

Product	Code	Operation Voltage	Applicable Contactor	Weight (kg)
Clamping Diode	HGC CD100	DC24 - 220 V	HGC9 - 100, HGR	0.029

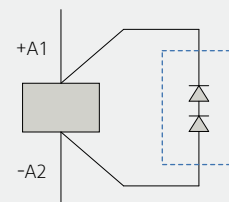

Electronic Timer Block

- Electronic timer block has modularized design which is space-saving and easy-assembling model.
- Wide voltage range of both AC and DC is applicable.
- Electronic timer block has both on-delay and interval function in one timer and it is suitable for various applications including Y- Δ starter.



Rating and Selection

Code	Applicable Contactor	Operation Voltage
HGC ET1	HGC9 - 100, HGR	AC/DC90 - 240 V
HGC ET2		AC/DC24 - 60 V



Rating and Features

Model	Code	HGC ET1	HGC ET2
Voltage Band	AC/DC V	90 - 240	24 - 60
Operation Voltage	V	(0.8 - 1.1) x rated voltage	
Breaking Capacity	VA	90	
Maximum Load	VA	15	
Delay Time	Position A	10 - 220	
	Position B	0.15 - 15	
Precision	%	± 5	
Error Ratio	%	0.1	
	Time	50 ms	
Weight	kg	0.053	

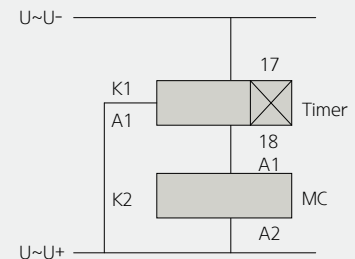

※ A1/A2: Coil Terminal 17/18: Timer Terminal

Operation Concept Map

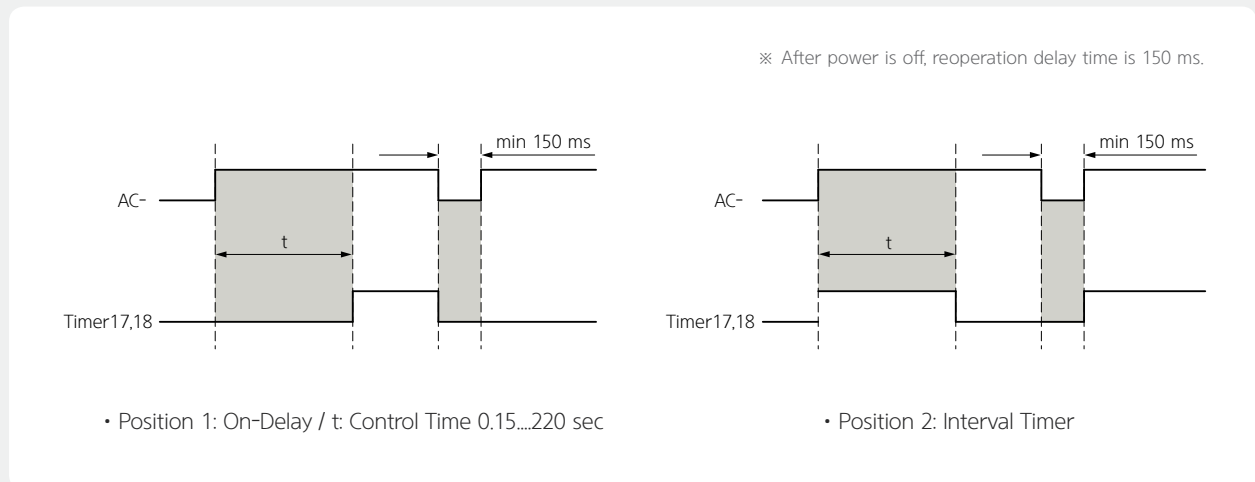

Accessories

Control Coil

Product	Operation Voltage		Code			
	Frequency	V	Applicable Contactor			
			HGC9 - 18	HGC25 - 40	HGC50 - 65	HGC75 - 100
	AC60 Hz	24	HGCOL18 A24	HGCOL40 A24	HGCOL65 A24	HGCOL100 A24
		48	HGCOL18 A48	HGCOL40 A48	HGCOL65 A48	HGCOL100 A48
		110	HGCOL18 A110	HGCOL40 A110	HGCOL65 A110	HGCOL100 A110
		120	HGCOL18 A120	HGCOL40 A120	HGCOL65 A120	HGCOL100 A120
		220	HGCOL18 A220	HGCOL40 A220	HGCOL65 A220	HGCOL100 A220
		240	HGCOL18 A240	HGCOL40 A240	HGCOL65 A240	HGCOL100 A240
		380	HGCOL18 A380	HGCOL40 A380	HGCOL65 A380	HGCOL100 A380
	AC50 Hz	440	HGCOL18 A440	HGCOL40 A440	HGCOL65 A440	HGCOL100 A440
		24	HGCOL18 X24	HGCOL40 X24	HGCOL65 X24	HGCOL100 X24
		48	HGCOL18 X48	HGCOL40 X48	HGCOL65 X48	HGCOL100 X48
		110	HGCOL18 X110	HGCOL40 X110	HGCOL65 X110	HGCOL100 X110
		120	HGCOL18 X120	HGCOL40 X120	HGCOL65 X120	HGCOL100 X120
		220	HGCOL18 X220	HGCOL40 X220	HGCOL65 X220	HGCOL100 X220
		240	HGCOL18 X240	HGCOL40 X240	HGCOL65 X240	HGCOL100 X240
	DC	380	HGCOL18 X380	HGCOL40 X380	HGCOL65 X380	HGCOL100 X380
		440	HGCOL18 X440	HGCOL40 X440	HGCOL65 X440	HGCOL100 X440
		24	HGCOL18 D24	HGCOL40 D24	HGCOL65 D24	HGCOL100 D24
		48	HGCOL18 D48	HGCOL40 D48	HGCOL65 D48	HGCOL100 D48
110		HGCOL18 D110	HGCOL40 D110	HGCOL65 D110	HGCOL100 D110	
 <p>※ When ordering HGC115 - 800's coil, AD Converter assembly will be provided.</p>	Voltage	V	Applicable Contactor			
			HGC115 - 150	HGC185 - 265	HGC300 - 500	HGC630 - 800
	24	AC24 - 26 DC24	HGCOL150 F24	HGCOL265 F24	-	-
	48	AC44 - 52 DC48	HGCOL150 F48	HGCOL265 F48	HGCOL400 F48	-
	110	AC100-127 DC100-110	-	-	-	HGCOL800 F110
	220	AC100 - 127 DC100 - 110	HGCOL150 F220	HGCOL265 F220	HGCOL400 F220	-
	220	AC200 - 240 DC200 - 220	-	-	-	HGCOL800 F220
440	AC380 - 450	HGCOL150 F440	HGCOL265 F440	HGCOL400 F440	HGCOL800 F440	

※ Control relay coils are marked as HGROL A220, D100, etc., and P type is not for sale individually.

Contacts and Covers

Product	Model	Contact	Code	Components
Main Contact		Applicable Contactor		1 SET Composition
 <p>Moving Contact</p>  <p>Fixed Contact</p>	HGCTIP	HGC9	HGCTIP9	Move Contact: 3 EA Fix Contact: 6 EA
		HGC12	HGCTIP12	
		HGC18	HGCTIP18	
		HGC25	HGCTIP25	
		HGC32	HGCTIP32	
		HGC40	HGCTIP40	
		HGC50	HGCTIP50	
		HGC65	HGCTIP65	
		HGC75	HGCTIP75	
		HGC85	HGCTIP85	
		HGC100	HGCTIP100	
		HGC115	HGCTIP115	
		HGC130	HGCTIP130	
		HGC150	HGCTIP150	
		HGC185	HGCTIP185	
		HGC225	HGCTIP225	
		HGC265	HGCTIP265	
		HGC300	HGCTIP300	
HGC400	HGCTIP400			
HGC500	HGCTIP500			
HGC630	HGCTIP630			
HGC800	HGCTIP800			
Terminal Cover				
 <p>Main Terminal Cover</p>  <p>Coil Terminal Cover</p>	HG CPC	HGC9 - 18	HGCPC18	Main Terminal Cover: 2 EA Coil Terminal Cover: 2 EA Auxiliary Terminal Cover: 2 EA
		HGC18 - 40	HGCPC40	
		HGC50 - 65	HGCPC65	
		HGC75 - 100	HGCPC100	
		HGC115 - 150	HGCPC150	Main Terminal Cover: 2 EA Coil Terminal Cover: 1 EA Auxiliary Terminal Cover: 8 EA
		HGC185 - 265	HGCPC265	
		HGC300 - 500	HGCPC500	
		HGC630 - 800	HGCPC800	
Front Protection Cover				
	HG CFC	HGC9 - 100	HGCFC100	1 EA
		HGC115 - 150	HGCFC150	
		HGC185 - 265	HGCFC265	
		HGC300 - 500	HGCFC400	
		HGC630 - 800	HGCFC800	

Technical Information

Features and Applications

Contactors can be selected according to categories: Rated thermal current (Ith), rated operating current (Ie), making and breaking capacities, electrical and mechanical endurance, and utilization.

 IEC 60947	AC1	Non-inductive or slightly inductive loads, resistance furnaces
	AC2	Slip-ring motors: starting, plugging
	AC3	Squirrel cage motors: starting, switching off motors during running
	AC4	Squirrel cage motors: plugging, inching
	AC12	Resistive heating loads
	AC15	Coil loads
	DC1	Non-inductive or slightly inductive loads, resistance furnaces
	DC3	Shunt motors: starting, plugging, and inching
	DC5	Series motors: starting, plugging, and inching
	DC12	Resistive heating loads
	DC13	Coil loads

Making and Breaking Capacities According to Utilization Categories

Category	Making				Making & Breaking			
	Current	Voltage	Cos ϕ	Cycles	Current	Voltage	Cos ϕ	Cycles
AC1	-	-	-	-	1.5 Ie	1.05 Ue	0.8	50
AC2	-	-	-	-	4.0 Ie	1.05 Ue	0.65	50
AC3	10 Ie	Ue	0.45 (≤ 100 A)	50	8.0 Ie	1.05 Ue	0.45 (≤ 100 A)	50
AC4	12Ie	Ue	0.35 (> 100 A)	50	10.0 Ie	1.05 Ue	0.35 (> 100 A)	50
AC15	-	-	-	-	10 Ie	1.1 Ue	0.3	10
DC1	-	-	-	-	1.5 Ie	1.05 Ue	1	50
DC3	-	-	-	-	4.0 Ie	1.05 Ue	2.5	50
DC5	-	-	-	-	4.0 Ie	1.05 Ue	15	50
DC13	-	-	-	-	1.1 Ie	1.1 Ue	6P	10

Operating Times According to Utilization Categories

Category	Making & Breaking				
	Current	Voltage	Cos ϕ	On-Time	Cycles
AC1	1.0 Ie	1.05 Ue	0.8	0.05 Sec	6,000
AC2	2.0 Ie	1.05 Ue	0.65	0.05 Sec	6,000
AC3	2.0 Ie	1.05 Ue	0.45 ($I_e \leq 100$ A)	0.05 Sec	6,000
AC4	6.0 Ie	1.05 Ue	0.35 ($I_e > 100$ A)	0.05 Sec	6,000
AC15	10 Ie	1.1 Ue	0.3	0.05 Sec	6,000
DC1	1.0 Ie	1.05 Ue	1	0.05 Sec	6,000
DC3	2.5 Ie	1.05 Ue	2	0.05 Sec	6,000
DC5	2.5 Ie	1.05 Ue	7.5	0.05 Sec	6,000
DC13	1.1 Ie	1.1 Ue	6P	0.05 Sec	6,000

Electrical Endurance According to Utilization Categories

Category	Making			Breaking		
	Current	Voltage	Cos ϕ	Current	Voltage	Cos ϕ
AC1	1.0 Ie	1 Ue	0.95	1 Ie	1 Ue	0.95
AC2	2.5 Ie	1 Ue	0.65	2.5 Ie	1 Ue	0.65
AC3	6 Ie	1 Ue	0.65 ($I_e \leq 17$ A)	6 Ie	0.17 Ue	0.65 ($I_e \leq 17$ A)
AC4	6 Ie	1 Ue	0.35 ($I_e > 17$ A)	6 Ie	1 Ue	0.35 ($I_e > 17$ A)
DC1	1 Ie	1 Ue	1	1 Ie	1 Ue	1
DC3	2.5 Ie	1 Ue	2	2.5 Ie	1 Ue	2
DC5	2.5 Ie	1 Ue	7.5	2.5 Ie	1 Ue	7.5

※ Ie: Rated operational current Ue: Rated operational voltage

Selections of AC3 and AC4 Contactors

- When operation frequency is lower than the recommendation, the load capacities can be increased, but should not exceed the rated making and breaking capacities of the contactors. If the thermal overload relay is used, the short-circuit protection should be carefully considered and the recommended fuse ratings should be obeyed.
- The contactors can be chosen according to the electrical lifetime by means of the following diagrams.

AC3 Electrical Lifetime Curve (380 - 440 VAC)

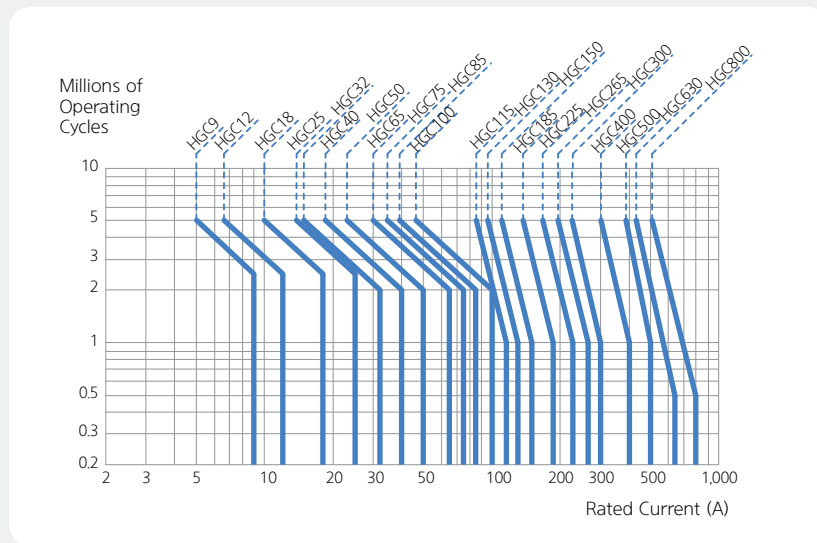

The electrical lifetime is calculated by the following formula if the load consist of AC3 and AC4 category.

$$L = \frac{1}{P1/L1 + P2/L2 + \dots + Pn/Ln}$$

- L: Electrical lifetime of contactor
- L1: Electrical lifetime in AC3 duty
- L2: Electrical lifetime in AC4 duty
- P1: Coefficient of use in AC3 duty
- P2: Coefficient of use in AC4 duty
- P1 + P2 + ... + Pn = 1

AC4 Electrical Lifetime Curve (380 - 440 VAC)

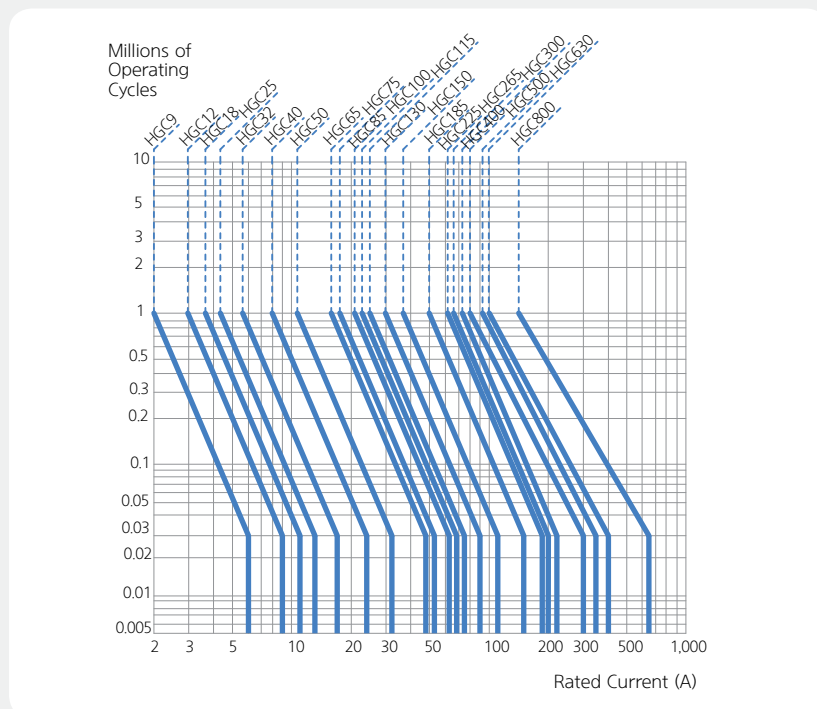

※ Example

Motor: 80 A full load current at AC 440 V, 480 A starting current (6 times of rated current)
 AC3 use: 70 A rated current with 95 % coefficient
 AC4 use: 70 A rated current (420 A starting current) with 5 % coefficient

$$L = \frac{10^6}{0.95/2.0 + 0.05/0.03} = 0.47 \times 10^6$$

- On AC3 electrical lifetime curve, the life time of HGC is 2.0 x 10⁶ (When operation current is 70 A)
- On AC4 electrical lifetime curve, the life time of HGC100 is 0.03 x 10⁶ (When operation current is 400 A)

Technical Information

Coil Characteristics

Contactor Model				HGC9	HGC12	HGC18	HGC25	HGC32	HGC40	HGC50	HGC65	HGC75	HGC85	HGC100		
Power Consumption	AC Coil DC Coil	AC operation coil(220 V/60 Hz)	Pull-in	VA	80	80	80	80	80	80	200	200	300	300	300	
			Hold-in	VA/W	10/2.5	10/2.5	10/2.5	10/2.5	10/2.5	10/2.5	15/5	15/5	25/10	25/10	25/10	25/10
	AC & DC Common Coil	AC operation coil (220 V/60 Hz)	Pull-in	VA	-	-	-	-	-	-	-	-	-	-	-	-
			Hold-in	VA/W	-	-	-	-	-	-	-	-	-	-	-	-
		AC operation coil (110 V/60 Hz)	Pull-in	VA	-	-	-	-	-	-	-	-	-	-	-	-
			Hold-in	VA/W	-	-	-	-	-	-	-	-	-	-	-	-
	DC operation coil	Pull-in	W	-	-	-	-	-	-	-	-	-	-	-	-	
		Hold-in	W	-	-	-	-	-	-	-	-	-	-	-	-	
	Operating Time	AC Coil DC Coil	Making Coil ON → Main contact ON	AC Control	msec	12 - 30	12 - 30	12 - 30	12 - 30	12 - 30	12 - 30	9 - 18	9 - 18	15 - 30	15 - 30	15 - 30
				DC Control	45 - 55	45 - 55	45 - 55	45 - 55	45 - 55	45 - 55	10 - 18	10 - 18	15 - 30	15 - 30	15 - 30	
AC Control		-		-	-	-	-	-	-	-	-	-	-	-		
DC Control		-		-	-	-	-	-	-	-	-	-	-	-		
AC Coil DC Coil		Breaking Coil Off → Main contact Off	AC Control	8 - 15	8 - 15	8 - 15	8 - 15	8 - 15	8 - 15	8 - 15	13 - 20	13 - 20	13 - 20	13 - 20	13 - 20	
			DC Control	6 - 18	6 - 18	6 - 18	6 - 18	6 - 18	6 - 18	6 - 18	13 - 20	13 - 20	13 - 20	13 - 20	13 - 20	
AC Control			-	-	-	-	-	-	-	-	-	-	-	-		
DC Control			-	-	-	-	-	-	-	-	-	-	-	-		
Control TR	AC or DC Operation Coil	Min. Capacities	VA	60	60	60	60	60	60	150	150	200	200	200		
	AC/DC Common Coil			-	-	-	-	-	-	-	-	-	-	-		

Coil Control Voltage

- 1) Application voltage: 85 - 110 %
- 2) Applied with higher rated voltage could shorten the lifetime of coil and electromagnetic parts, even make it burn.
- 3) If other coil voltage is applied, please contact HHI.

Category	Coil Operation Voltage
AC 50 Hz	24, 48, 110, 120, 220, 240, 380, 440 V
AC 60 Hz	24, 48, 110, 120, 220, 240, 380, 440 V
DC	24, 48, 110, 120, 220 V

※ The operating time of AC/DC common coil type MC is average time in the condition of AC220 V 60 HZ, and DC110 V.

※ For HGC9-100, A1(A2) on line side is internally connected to A1(A2) on load side. Be careful not to wire incorrectly. It results in a short circuit failure.

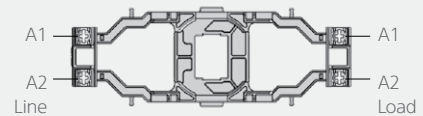

Auxiliary Contact Specification



IEC 60947 Standard

Rated Insulation Voltage (Ui)	AC750 V							
Conventional Thermal Current (Ith)	16 A							
Rated Operational Current	AC12 (Resistive Load)		AC15 (Coil Load)		DC12 (Resistive Load)		DC13 (Coil Load)	
	110 V	10 A	110 V	6 A	24 V	4 A	24 V	4 A
	220 V	8 A	220 V	4 A	48 V	2.5 A	48 V	2.5 A
	440 V	6 A	440 V	3 A	125 V	1.1 A	125 V	1.1 A
	690 V	2 A	690 V	2 A	220 V	0.3 A	250 V	0.3 A



HGC115	HGC130	HGC150	HGC185	HGC225	HGC265	HGC300	HGC400	HGC500	HGC630	HGC800
-	-	-	-	-	-	-	-	-	-	-
-	-	-	-	-	-	-	-	-	-	-
-	-	-	-	-	-	-	-	-	-	-
-	-	-	-	-	-	-	-	-	-	-
530	530	530	360	360	360	390	390	390	1,700	1,700
7.4/3.8	7.4/3.8	7.4/3.8	9.3/5.8	9.3/5.8	9.3/5.8	9.3/5.8	9.3/5.8	9.3/5.8	17.1/10.6	17.1/10.6
240	240	240	250	250	250	250	250	250	850	850
3.3/2.1	3.3/2.1	3.3/2.1	6.4/4.4	6.4/4.4	6.4/4.4	6.4/4.4	6.4/4.4	6.4/4.4	10.5/8	10.5/8
193	193	193	420	420	420	420	420	420	850	850
2.3	2.3	2.3	3.4	3.4	3.4	3.4	3.4	3.4	9.5	9.5
-	-	-	-	-	-	-	-	-	-	-
-	-	-	-	-	-	-	-	-	-	-
40 - 80	40 - 80	40 - 80	40 - 80	40 - 80	40 - 80	40 - 80	40 - 80	40 - 80	45 - 150	45 - 150
70 - 80	70 - 80	70 - 80	35 - 45	35 - 70	35 - 70	35 - 70	35 - 70	35 - 70	45 - 150	45 - 150
-	-	-	-	-	-	-	-	-	-	-
-	-	-	-	-	-	-	-	-	-	-
18 - 25	18 - 25	18 - 25	40 - 50	40 - 50	40 - 50	35 - 50	35 - 50	35 - 50	45 - 150	45 - 150
15 - 20	15 - 20	15 - 20	35 - 45	35 - 45	35 - 45	35 - 45	35 - 45	35 - 45	45 - 150	45 - 150
-	-	-	-	-	-	-	-	-	-	-
200	200	200	200	200	200	200	200	200	1,000	1,000

AC/DC Common Coil

Nominal Voltage	AC	DC
24 V	24 - 26 V	24 V
48 V	44 - 52 V	48 V
220 V	100 - 240 V	110 - 220 V
440 V	380 - 450 V	-

AC/DC Common Coil

Nominal Voltage	AC	DC
48 V	44 - 52 V	48 V
110 V	100 - 127 V	100 - 110 V
220 V	200 - 240 V	200 - 220 V
440 V	380 - 450 V	-

UL or CSA Standard



Auxiliary Contact



Thermal Current	16 A			
	AC		DC	
Rated Operational Current	120 V	6 A	125 V	1.1 A
	240 V	3 A	250 V	0.3 A
	480 V	1.5 A	440 V	0.2 A
	600 V	1.2 A	600 V	0.2 A

※ Contact Rating Code: A600 - P300

Technical Information

Rated Operational Current with DC Load

Connection	Application	Operation Voltage	HGC9	HGC12	HGC18	HGC25	HGC32	HGC40	HGC50	HGC65	HGC75	HGC85	HGC100
2 Poles in Series	DC1 Resistive Load (L/R ≤ 1ms)	24 V	10	12	18	20	25	35	50	65	65	75	80
		48 V	10	12	18	20	25	35	40	65	65	65	65
		110 V	6	10	13	15	25	25	35	45	45	50	50
		220 V	3	7	8	10	12	12	15	15	15	20	20
	DC3,DC5 DC Motor Load (L/R ≤ 15ms)	24 V	8	12	12	20	25	35	45	45	45	65	65
		48 V	4	6	6	15	20	20	25	25	25	40	40
		110 V	2.5	4	4	8	10	10	15	15	15	20	20
		220 V	0.8	1.2	1.2	2	3	3	3.5	3.5	3.5	5	5
	DC13 Coil Load (L/R ≤ 40ms)	24 V	8	12	12	20	25	35	-	-	-	-	-
		48 V	4	6	6	12	15	15	-	-	-	-	-
		110 V	2	3	3	3	4	4	-	-	-	-	-
		220 V	0.3	0.5	0.5	1.2	1.2	1.2	-	-	-	-	-
3 Poles in Series	DC1 Resistive Load (L/R ≤ 1ms)	24 V	10	12	18	20	25	35	50	65	65	75	80
		48 V	10	12	18	20	25	35	50	65	65	75	80
		110 V	8	12	18	20	25	35	50	65	65	75	80
		220 V	8	12	18	20	25	30	40	50	50	55	60
	DC3,DC5 DC Motor Load (L/R ≤ 15ms)	24 V	8	12	12	20	25	35	50	50	50	80	80
		48 V	6	10	10	20	25	30	35	35	35	60	60
		110 V	4	8	8	15	20	20	30	30	30	50	50
		220 V	2	4	4	8	10	10	12	12	12	20	20
	DC13 Coil Load (L/R ≤ 40 ms)	24 V	8	12	12	20	25	35	-	-	-	-	-
		48 V	6	10	10	15	25	35	-	-	-	-	-
		110 V	3	5	5	10	12	12	-	-	-	-	-
		220 V	0.8	2	2	4	4	4	-	-	-	-	-

Connection	Application	Operation Voltage	HGC115	HGC130	HGC150	HGC185	HGC225	HGC265	HGC300	HGC400	HGC500	HGC630	HGC800
2 Poles in Series	DC1 Resistive Load (L/R ≤ 1ms)	24 V	100	120	150	180	220	260	300	400	500	630	800
		48 V	100	100	120	180	180	220	240	240	300	630	800
		110 V	80	80	100	150	150	180	200	200	220	630	630
		220 V	50	50	100	150	150	180	200	200	220	630	630
	DC3,DC5 DC Motor Load (L/R ≤ 15ms)	24 V	100	120	150	180	220	260	300	400	500	630	800
		48 V	60	60	100	150	150	180	200	200	260	630	800
		110 V	40	40	80	120	120	130	150	150	180	630	630
		220 V	30	30	60	80	80	80	90	90	130	210	210
	DC13 Coil Load (L/R ≤ 40ms)	24 V	-	-	-	-	-	-	-	-	-	-	-
		48 V	-	-	-	-	-	-	-	-	-	-	-
		110 V	-	-	-	-	-	-	-	-	-	-	-
		220 V	-	-	-	-	-	-	-	-	-	-	-
3 Poles in Series	DC1 Resistive Load (L/R ≤ 1ms)	24 V	100	120	150	180	220	260	300	400	500	630	800
		48 V	100	120	150	180	220	260	300	400	500	630	800
		110 V	100	100	150	180	220	260	300	400	500	630	630
		220 V	80	80	150	180	220	260	300	300	400	630	630
	DC3,DC5 DC Motor Load (L/R ≤ 15ms)	24 V	100	120	150	180	220	260	300	400	500	630	800
		48 V	90	90	130	180	220	260	280	280	400	630	800
		110 V	80	80	120	150	150	180	200	200	260	630	630
		220 V	50	50	80	100	100	130	150	150	180	310	310
	DC13 Coil Load (L/R ≤ 40 ms)	24 V	-	-	-	-	-	-	-	-	-	-	-
		48 V	-	-	-	-	-	-	-	-	-	-	-
		110 V	-	-	-	-	-	-	-	-	-	-	-
		220 V	-	-	-	-	-	-	-	-	-	-	-

Specification for Tranformer and Condenser Load

Load	Operational Voltage	HGC9	HGC12	HGC18	HGC25	HGC32	HGC40	HGC50	HGC65	HGC75	HGC85	HGC100	
Trans- former (kVA)	Single Phase	AC220 V	1	1.5	2	2.5	3	4	5	7	8	9	10
		AC440 V	1.5	2	3	4	5	7.5	10	15	17	18	20
	Three Phase	AC220 V	2	3	3.5	4	5	6.5	10	12	13	15	18
		AC440 V	2.5	4	5	7.5	10	12	18	25	27	30	35
Condenser (kVAR)	Three Phase	AC220 V	2	3	4	5	9	11	13	17	20	22	24
		AC440 V	3	4	6	10	16	20	24	34	40	45	48

Load	Operational Voltage	HGC115	HGC130	HGC150	HGC185	HGC225	HGC265	HGC300	HGC400	HGC500	HGC630	HGC800	
Trans- former (kVA)	Single Phase	AC220 V	-	15	17	20	25	30	33	44	55	65	90
		AC440 V	-	25	33	40	50	57	66	90	110	130	175
	Three Phase	AC220 V	-	25	30	35	42	48	57	75	90	110	150
		AC440 V	-	42	60	70	85	95	100	150	180	220	300
Condenser (kVAR)	Three Phase	AC220 V	-	29	35	42	58	63	69	92	115	145	185
		AC440 V	-	58	70	84	115	125	139	185	230	291	369

※ - The inrush current of transformer shall be less than 30 times of rated current (RMS).
- Electrical Lifetime: 100,000 times (IEC 60947-4-1, AC6a, 6b)

Light load - Maximum Incandescent Lamp Quantity Per Contactor

Lighting Load Application

The contactor for lighting load can be selected by the rated thermal current (I_{th}) on the condition that inrush current does not exceed contactor's breaking capacity. Usually, lighting load switching frequency is smaller than the other applications, so electrical lifetime would not be the major parameter to select contactor.

Incandescent Lamp

The contactor for incandescent lamps can be selected according to AC3 utilization category considering inrush current at hot condition. The resistance of the incandescent lamp filament is small at cold condition, so the inrush current can be 13 - 16 times of the rated current instantaneously. However, the inrush current at hot condition is limited to 7 - 10 times of rated current by circuit impedance and self-heating. Therefore, it is recommended to consider the inrush current at hot condition rather than cold condition to select contactor.

Power Voltage		110 V							
Lamp Power		100 W	150 W	200 W	250 W	300 W	500 W	1,000 W	1,500 W
Contactor Model	HGC9	11	7	5	4	2	2	1	-
	HGC12	14	8	6	5	4	2	1	-
	HGC18	19	13	10	7	6	3	1	1
	HGC25	20	13	10	8	6	3	1	1
	HGC32	28	18	14	11	9	5	2	1
	HGC40	38	25	19	15	12	7	3	2
	HGC50	55	35	27	22	16	10	5	3

Power Voltage		220 V							
Lamp Power		100 W	150 W	200 W	250 W	300 W	500 W	1,000 W	1,500 W
Contactor Model	HGC9	22	14	11	8	7	4	2	1
	HGC12	26	18	14	10	8	5	2	1
	HGC18	38	25	20	15	13	7	3	2
	HGC25	40	27	20	16	13	8	3	2
	HGC32	55	36	28	22	18	11	5	3
	HGC40	75	50	38	30	25	15	7	4
	HGC50	105	70	54	43	35	22	10	6

Technical Information

Application for Y-Δ Starting

Voltage · Current · Torque for Y-Δ Starting

Starting (Star Type Contactor / C3)				Operating (Delta Type Contactor / C2)			
Starting Method	Starting Current	Torque	Full Load Current	Contact Voltage	Full Load Current	Contact Current	Contact Voltage
Directly Online	6 Im	1.5 T	6 Im	Em/√3	Im	Im	Em/√3
Star-delta	2 Im	0.5 T	2 Im	Em/√3	Im	Im/√3	Em

※ Im: Load current (delta type connection) Em: Line voltage T: Rating voltage (assumed torque fluctuations)

Contactor and Thermal Overload Relay for Normal Y-Δ Starter

200 - 240 V AC, 3Ø, 60 Hz							380 - 440 V AC, 3Ø, 60 Hz						
Motor Capacity			Main Circuit	Δ Circuit	Y Circuit	TOR	Motor Capacity			Main Circuit	Δ Circuit	Y Circuit	TOR
kW	Hp	FLC	(C1)	(C2)	(C3)		kW	Hp	FLC	(C1)	(C2)	(C3)	
5.5	7.5	22	HGC25	HGC25	HGC18	HGT40K	5.5	7.5	12	HGC25	HGC25	HGC25	HGT40K
7.5	10	32	HGC32	HGC32	HGC25	HGT40K	7.5	10	18	HGC25	HGC25	HGC25	HGT40K
11	15	40	HGC40	HGC40	HGC32	HGT40K	11	15	22	HGC25	HGC25	HGC25	HGT40K
15	20	50	HGC50	HGC50	HGC32	HGT65K	15	20	32	HGC32	HGC32	HGC25	HGT40K
18.5	25	70	HGC50	HGC50	HGC40	HGT65K	18.5	25	40	HGC40	HGC40	HGC25	HGT40K
22	30	80	HGC75	HGC75	HGC40	HGT100K	22	30	50	HGC40	HGC40	HGC32	HGT40K
30	40	110	HGC100	HGC100	HGC50	HGT100K	30	40	65	HGC50	HGC50	HGC40	HGT65K
37	50	130	HGC115	HGC115	HGC65	HGT150K	37	50	80	HGC75	HGC75	HGC40	HGT100K
45	60	150	HGC130	HGC130	HGC65	HGT150K	45	60	90	HGC75	HGC75	HGC40	HGT100K
55	75	180	HGC150	HGC150	HGC100	HGT150K	55	75	110	HGC100	HGC100	HGC50	HGT100K
75	100	260	HGC185	HGC185	HGC115	HGT265K	75	100	150	HGC115	HGC115	HGC65	HGT150K
90	125	300	HGC225	HGC225	HGC130	HGT265K	90	125	180	HGC130	HGC130	HGC100	HGT150K
110	150	367	HGC300	HGC300	HGC150	HGT500K	110	150	220	HGC150	HGC150	HGC115	HGT150K
132	180	434	HGC400	HGC400	HGC225	HGT500K	132	180	260	HGC185	HGC185	HGC115	HGT265K
160	220	519	HGC400	HGC400	HGC225	HGT500K	160	220	300	HGC225	HGC225	HGC130	HGT265K
250	350	810	HGC630	HGC630	HGC400	HGT800K	250	350	500	HGC400	HGC400	HGC225	HGT500K
300	-	-	-	-	-	-	300	402	560	HGC400	HGC400	HGC300	HGT500K

- ※ - Above data is based on squirrel cage motor (AC3) and slip-ring motor (AC2). Data is subject to change according to motor classes and motor manufacturers.
- Above data is based on less than 10 seconds of motor starting time. Motor starting time should be carefully considered when over 10 seconds of motor starting time is applied.
- Inrush current shall be carefully considered when a capacitor is used.
- Recommendable change-over time of Y-Δ is between 30 ms and 80 ms.
- 58 % of motor full load current is recommended for HGT setting current.

Main Circuit Diagram

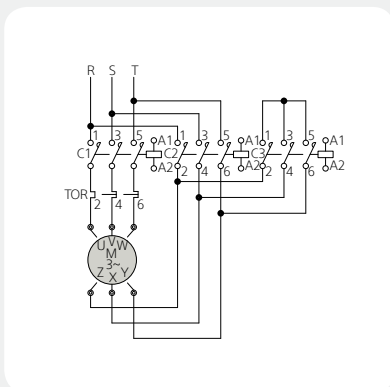

Control Circuit

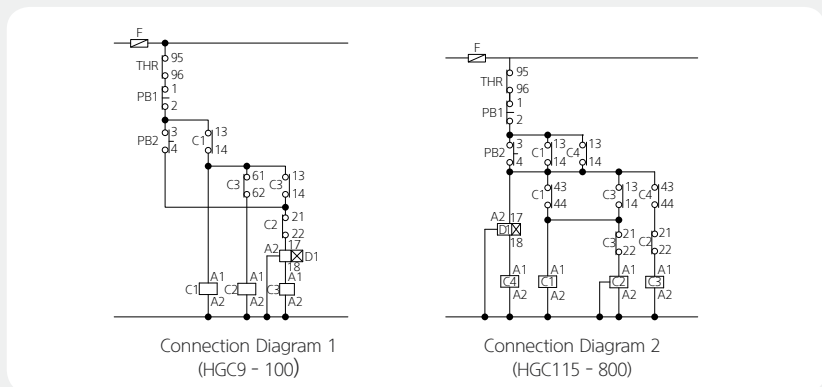

C1: Main MC C2: Delta MC C3: Star MC D1: Timer C4: Auxiliary Relay

Applicable Wire Size and Screwing Torque

Main Circuit

Model	Terminal Screw	Applicable Wire Size (mm ²)	Ring Tongue Terminal (mm ²)	Screwing Torque (kgf.cm)
HGC9	M4	1.25 - 5.5	1.5-M4 - 5.5-M4	15
HGC12	M4	1.25 - 5.5	1.5-M4 - 5.5-M4	15
HGC18	M4	1.25 - 14	1.5-M4 - 5.5-M4	15
HGC25	M5	1.25 - 14	2-M5 - 14-M5	26
HGC32	M5	1.25 - 14	2-M5 - 14-M5	26
HGC40	M5	2 - 22	2-M5 - 22-M5	26
HGC50	M6	2 - 22	1.25-M6 - 22-M6	40
HGC65	M6	2 - 22	1.25-M6 - 22-M6	60
HGC75	M8	2 - 38	2-M8 - 38-M8	60
HGC85	M8	2 - 38	2-M8 - 38-M8	60
HGC100	M8	2 - 38	2-M8 - 38-M8	60
HGC115	M8	2 - 60	2-M8 - 60-M8	60
HGC130	M8	2 - 60	2-M8 - 60-M8	60
HGC150	M8	2 - 60	2-M8 - 60-M8	60
HGC185	M8	2 - 150	2-M10 - 150-M10	100
HGC225	M10	2 - 150	2-M10 - 150-M10	100
HGC265	M10	2 - 150	2-M10 - 150-M10	100
HGC300	M10	2 - 240	2-M12 - 240-M12	140
HGC400	M12	2 - 240	2-M12 - 240-M12	140
HGC500	M12	2 - 240	2-M12 - 240-M12	140
HGC630	M16	80 - 325	80-M16 - 325-M16	140
HGC800	M16	80 - 325	80-M16 - 325-M16	140



Control Circuit

Model	Terminal Screw	Applicable Wire Size (mm ²)	Ring Tongue Terminal (mm ²)	Screwing Torque (kgf.cm)
HGC9 - 100	M3.5	1.25 - 2	1.25 - M3.5 - 2 - M.5	12
HGC115 - 800				

Technical Information

Inching and Plugging Duty

• AC4 Utilization Category

Category	Voltage	Ratio	Electrical Lifetime	HGC9	HGC12	HGC18	HGC25	HGC32	HGC40	HGC50	HGC65	HGC75	HGC85	HGC100	
Inching	220 V	10 %	100,000	2.2	2.7	3.7	4	5.5	7.5	11	15	18.5	19	25	
			500,000	1	1.5	2.7	3.7	4.5	5.5	7.5	11	15	15	15	
		50 %	100,000	1	1.5	2.7	3.7	4.5	5.5	7.5	11	15	15	15	19
			500,000	0.5	0.75	1.1	1.5	2.2	3.7	3.7	5.5	7.5	7.5	9	
		100 %	100,000	0.75	1.1	1.5	2.5	4.5	4.5	5.5	7.5	9	11	11	
			500,000	0.3	0.5	0.75	1.1	1.8	2.7	3.7	4	4	5.5	5.5	
	440 V	10 %	100,000	2.7	4	4	7.5	11	15	22	30	37	37	50	
			500,000	1.5	2.2	3.7	7.5	9	11	15	22	30	30	37	
		50 %	100,000	1.5	3.7	4	7.5	9	11	15	22	30	30	37	
			500,000	0.75	1.5	2.2	3.7	4.5	5.5	7.5	11	15	15	18.5	
		100 %	100,000	1.1	2.2	3.7	5.5	7.5	11	15	15	15	22	25	
			500,000	0.5	1.1	1.5	2.2	3.7	3.7	5.5	7.5	7.5	11	13	
Plugging	220 V	Plugging Brake 100 %	100,000	0.75	0.75	1.5	2.2	2.5	3.7	5.5	7.5	9	9	11	
			500,000	0.2	0.4	0.5	0.75	1.1	1.5	2.2	3	3.7	3.7	4.5	
	440 V		100,000	0.75	1	2.2	3.7	4.5	4.5	7.5	11	18.5	18.5	22	
			500,000	0.2	0.4	0.75	1.5	2.2	2.2	3.7	5.5	7.5	7.5	11	

Category	Voltage	Ratio	Electrical Lifetime	HGC115	HGC130	HGC150	HGC185	HGC225	HGC265	HGC300	HGC400	HGC500	HGC630	HGC800
Inching	220 V	10 %	100,000	30	30	37	45	55	65	75	110	132	160	200
			500,000	15	22	25	30	37	45	50	65	70	75	132
		50 %	100,000	22	22	30	37	45	50	55	75	80	90	150
			500,000	9	9	11	15	19	22	25	30	32	37	45
		100 %	100,000	11	15	19	25	30	32	37	45	50	55	75
			500,000	5.5	7.5	9	11	15	17	22	25	30	37	45
	440 V	10 %	100,000	50	60	75	90	110	132	150	200	250	300	400
			500,000	37	45	55	75	90	110	125	132	140	150	190
		50 %	100,000	37	45	55	75	90	110	132	150	167	190	220
			500,000	18.5	22	30	37	37	42	50	75	80	90	110
		100 %	100,000	25	30	45	55	60	65	75	110	120	132	160
			500,000	13	15	22	25	30	32	37	55	63	75	90
Plugging	220 V	Plugging Brake 100 %	100,000	11	15	19	22	25	30	37	45	50	55	75
			500,000	4.5	5.5	7.5	11	13	15	18.5	22	25	30	37
	440 V		100,000	22	30	37	45	45	49	55	75	90	110	150
			500,000	11	15	19	22	25	26	30	37	40	45	75

※ The inching limit of making and breaking frequency is below 10 continuous operation (1 sec/1 cycle)

$$\text{Ratio of Inching Operation (\%)} = \frac{\text{Inching Operations}}{\text{Standard Operations} + \text{Inching Operations}} \times 100$$

Rating Based on UL

Category		HGC9	HGC12	HGC18	HGC25	HGC32	HGC40	HGC50	HGC65	HGC75	HGC85	HGC100	
Continuous Current (Ambient Temperature 40 °C)		A	21	21	30	40	50	60	70	80	90	105	125
Single Phase	1P/100 - 120 V	hp/A	0.5/9.8	1/16	1.5/16	2/20	2/24	3/34	5/56	5/56	-	-	-
	1P/220 - 240 V		1/8	2/12	3/17	3/17	5/28	7.5/40	10/50	10/50	-	-	-
Three Phases	3P/220 - 240 V		2/6.8	3/9.6	5/15.2	10/28	10/28	15/42	20/54	20/54	25/68	30/80	30/80
	3P/440 - 480 V		5/7.6	7.5/11	10/14	20/27	25/34	30/40	40/52	40/52	60/77	60/77	60/77
	3P/550 - 600 V		5/6.1	10/11	15/21	15/21	20/22	30/32	30/42	40/52	50/52	50/52	75/77
NEMA Size				00	00	0	0	1	1	2	2	2	3

Category		HGC115	HGC130	HGC150	HGC185	HGC225	HGC265	HGC300	HGC400	HGC500	HGC630	HGC800	
Continuous Current (Ambient Temperature 40 °C)		A	160	180	210	230	260	330	350	450	550	750	900
Single Phase	1P/100 - 120 V	hp/A	-	-	-	-	-	-	-	-	-	-	-
	1P/220 - 240 V		-	-	-	-	-	-	-	-	-	-	-
Three Phases	3P/220 - 240 V		40/104	40/104	50/130	60/154	75/192	100/248	100/248	150/360	150/360	250/480	300/720
	3P/440 - 480 V		75/96	75/96	100/124	125/156	150/180	200/240	250/302	300/361	300/361	500/477	600/708
	3P/550 - 600 V		100/99	100/99	125/125	150/144	200/192	250/242	250/242	300/289	350/336	500/382	600/578
NEMA Size				3	3	4	4	4	4	5	5	5	6

Technical Information

Effect of Cable Length on Magnetic Contactor

Voltage Drop by Inrush Current and Resistive Circuit

Voltage drop occurs on control circuit when inrush current caused by resistance of conductor is supplied to coil. Excessive voltage drop on power control cable (for both AC and DC) might cause coil to burn. Therefore, the length of connection cable should be decided considering input power, supply voltage, and cross sectional area of conducting wire.

Selection for Conductor C.S.A. According to Inrush Power

These graphs show maximum 5 % line voltage drop.

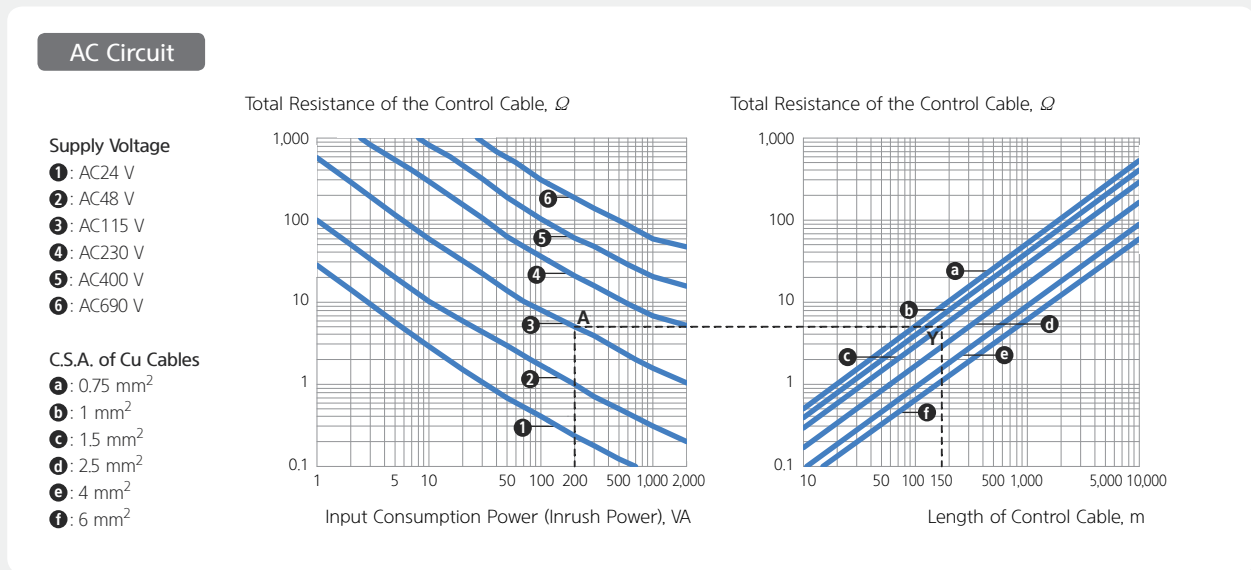

※ Example: The maximum length of conductor required when using 1.5 mm² Cu control cable, HGC 40 A, 115 V with inrush power 200 VA is 150 m.

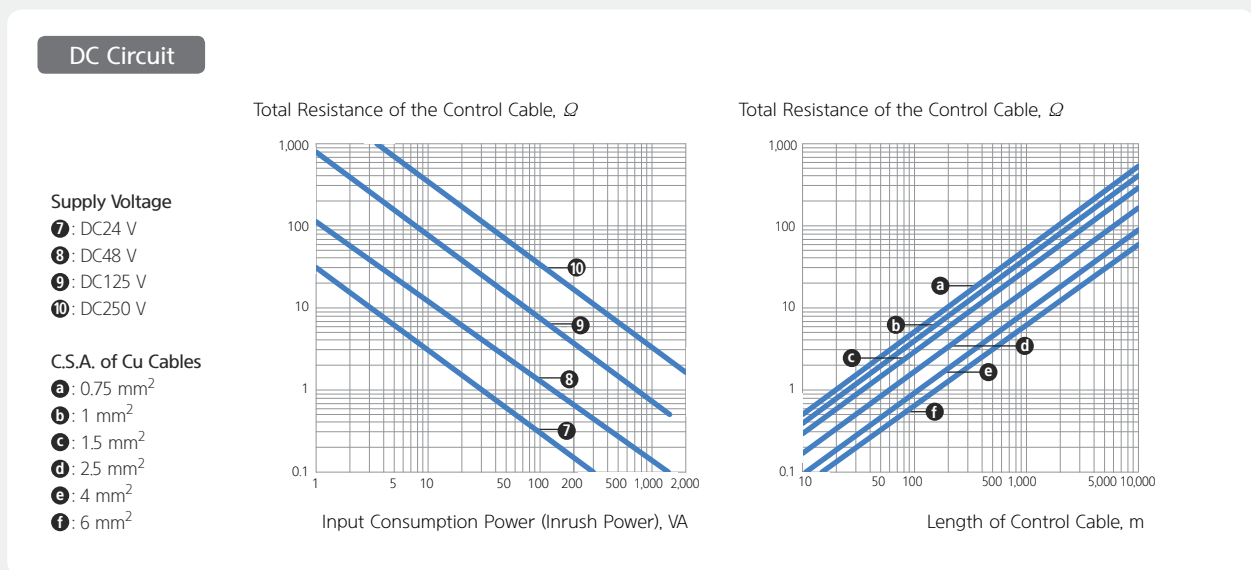

Maximum Cable Distance Calculation

$$L = \frac{U^2}{SA} \cdot s \cdot K$$

L: Distance between conductors and controlling equipment (length of cable)
 U: Power supply in V

SA: Apparent inrush power for coil in VA
 s: Conductor C.S.A. in mm²
 K: Factors given in following table

AC Supply	SA (VA)	20	40	100	150	200
	K	1.38	1.5	1.8	2	2.15
DC Supply	Irrespective of the apparent inrush power SA, expressed in W					
	k = 1.38					

Trip Failure Due to Cable Capacitance (AC)

Control cable's capacitance might cause trip failure when the control circuit of contactors is opened.

This phenomenon can be worsened by the following conditions, so when deciding the length of conducting cable, the following should be considered.

- Too long distance between coil terminal and power source or between coil terminal and contactors.
- Too high of control circuit voltage
- Too low of coil power consumption
- Too low of drop-out voltage

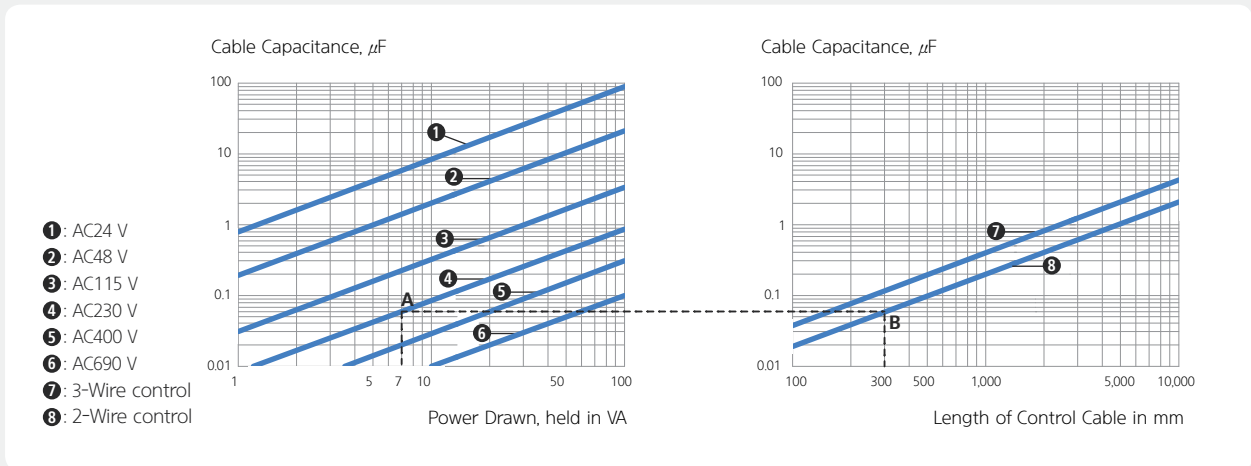

※ Example: The maximum distance for control cable of HGC12 contact which is operated by 230 V and 2-wire control with hold in power of 7 VA, is 300 m.

Maximum Cable Distance Calculation According to Cable Capacitance

$$L = 455 \cdot \frac{S}{U^2 \cdot Co}$$

L: Distance between contact and control equipment m (cable length)
 S: Apparent sealed power VA

U: Control voltage V
 Co: Line capacitance capacity for cable

Technical Information

Structure and Features of TOR

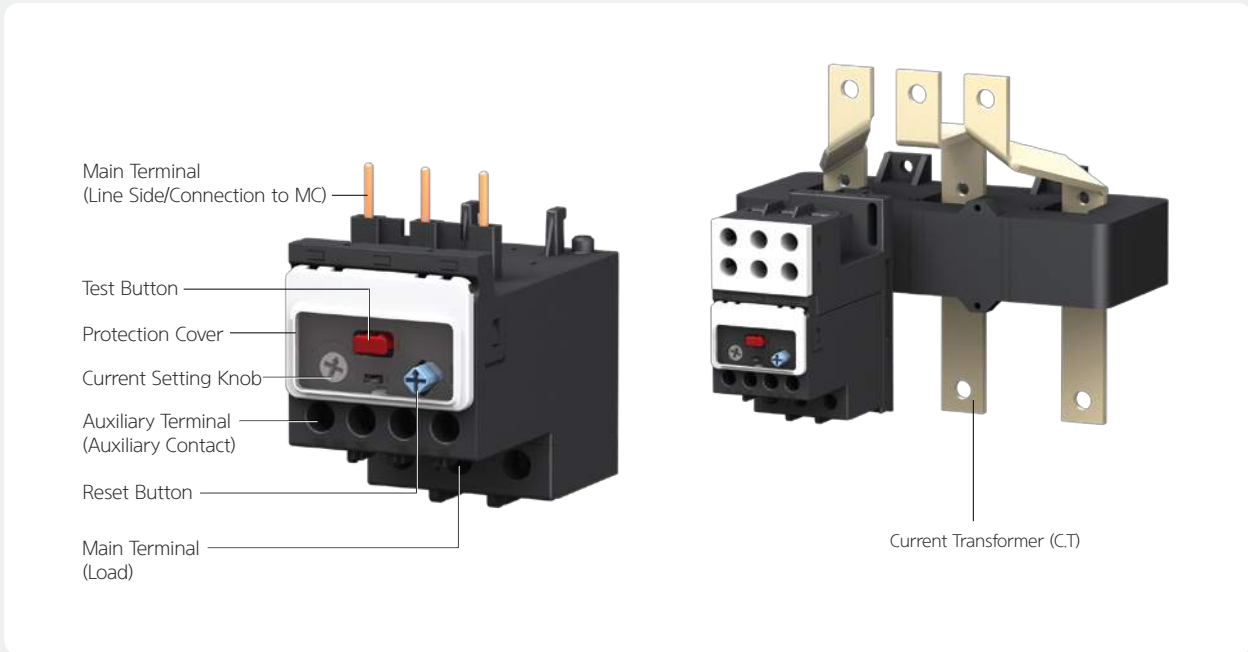

Test Button

- When test button is pushed, the contact from MC is opened which makes the motor stop. This button is also used for emergency stop.
- If the test button is pulled up, the status of TOR becomes trips status; trip indicator comes up, NC contact opens, and NO contact closes.

Protection Cover

- Unintended change of set current or pushing reset button can be prevented by the protection cover.
- When changing TOR settings, raise the cover and change the settings.

Current Setting Knob

- Three steps of setting current can be adjusted by "+" or "-" driver.

Phase Loss Protection: Differential Tripping Mechanism

- Differential tripping mechanism makes trip faster in the case of single phase loss than all three phase overloaded condition. As shown in the figure, when R phase in loss, the bimetal of R phase remains, so it fixes up the lower slide. At the same time, the other bimetals of S and T phase are bent, then they move the upper slide. It is also the same for S and T phase in loss.

Reset Button

- A (Automatic) Position: Automatic reset
- H (Manual) Position: Manual reset

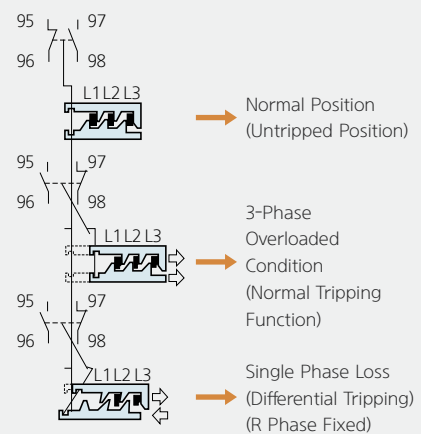

- L1/L2/L3: LINE3 Phase (R, S, T Phase)
 - 95/96/97/98: TOR Auxiliary Contact Terminal

Selection Method

Short Starting Time Motors

- For the normal starting time motors within a few seconds relays can be selected by the table of page 56. The full load current (FLC) of the motor must be in the setting range of the thermal overload relay. The starting time of high-inertia motor is an important factor at the selection of thermal overload relays
- The tripping time of the motors, whose starting current is 6-7 times of the rated current, can be obtained from the HGT tripping curves. This time should be longer than about 125 % of the motor starting time.

Long Starting Time Motors

- If the starting time of the motor is longer than the tripping time of HGT, the current transformer type is applicable.
- The current transformer type relays include the non-tripping features during the motor starting time. The rated current can be decreased by looping primary cable several times on the transformer according to the following table.

Current Configuration Ratio According to Loop Turns (Example: 130 A)

Primary Loop Turns	Current Range (A)	Current Ratio
1	78 - 130	130/5
2	39 - 65	65/5
3	26 - 26.7	26.7/5
4	19.5 - 43.3	43.3/5
5	15.6 - 26	26/5
6	13 - 21.7	21.7/5
7	11.14 - 18.5	18.5/5
8	9.75 - 16.25	16.25/5

$$\text{Setting Current (A)} = \frac{\text{Rated Current of Motor}}{\text{Current Ratio}}$$

- The second rated current of current transformer is 5 A, the overload relay is able to control the current between 3 A and 5 A.
- The corresponding setting value for the relay can be calculated by using the following formula.

Making and Breaking Current of Auxilliary Contacts

Class	AC15 ¹⁾		Class	DC13 ²⁾		
	Aux. Contact 95 - 96	Alarm Contact 97 - 98		Voltage (V)	Aux. Contact 95 - 96	Alarm Contact 97 - 98
	le (A)	le (A)			le (A)	le (A)
110	2	1.2	24	1	1	
220	1.5	1	110	0.4	0.4	
500	1	0.5	220	0.15	0.15	
660	0.5	0.3	440	0.07	0.07	

※ 1) AC15: Making/Breaking Current = $le \times 10$

2) DC13: Making/Breaking Current = $le \times 1.1$

Technical Information

Characteristic Curve of Thermal Overload Relay

- Tripping curve of 3 phase overloaded condition shows the average tripping time based on the cold starting at + 20 °C ambient temperature. (Tripping time of hot starting is 20 - 40 % of cold starting)
- Average tripping time of single phase overloaded condition is 40 - 60 % of three phase overload.

HGT18K

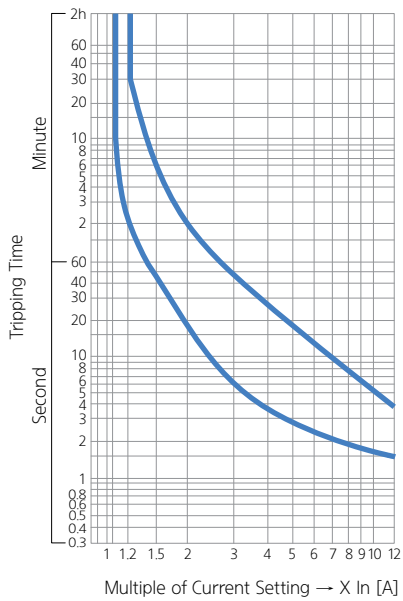

HGT40K

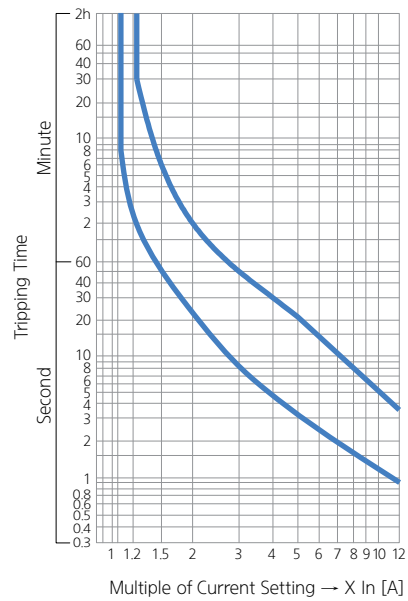

HGT65K

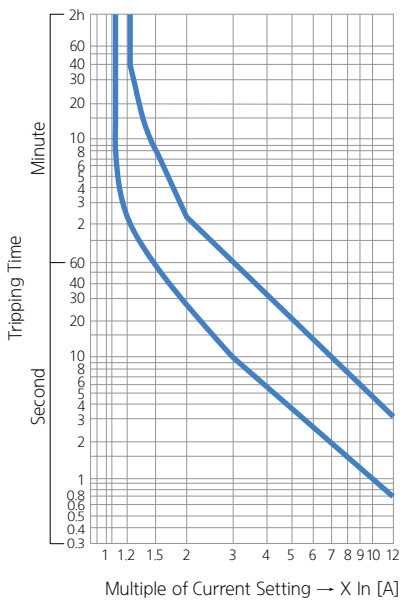

HGT100K

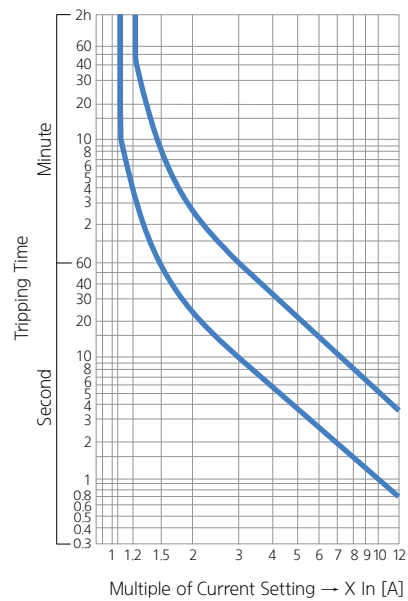

HGT150K

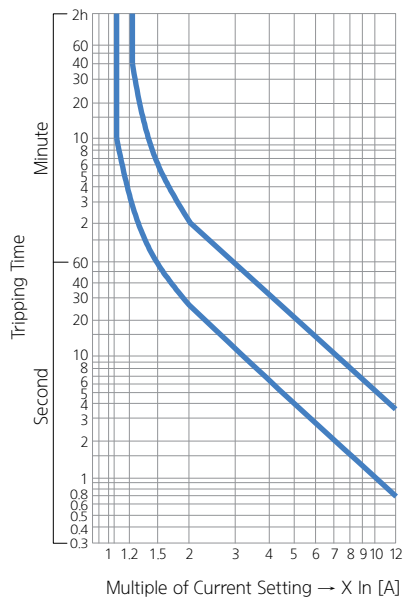

HGT265K

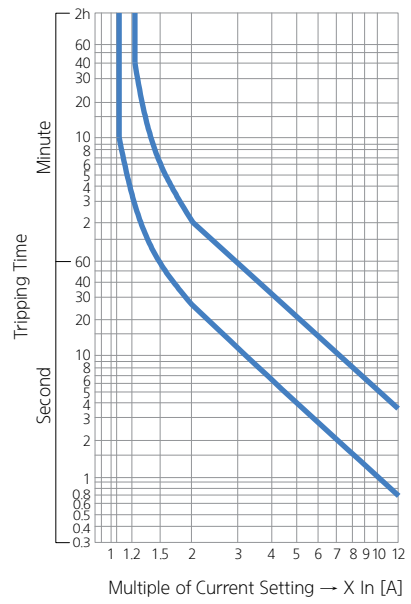

HGT400K

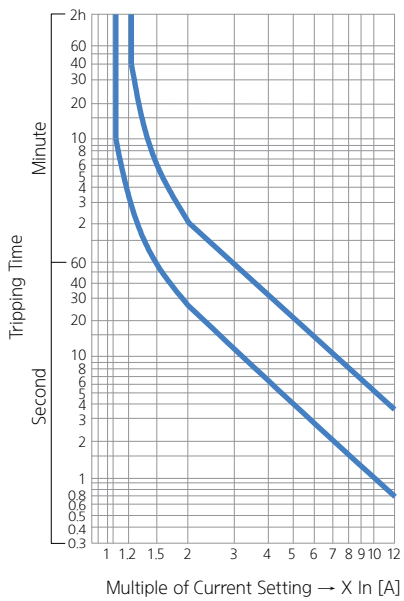

HGT800K

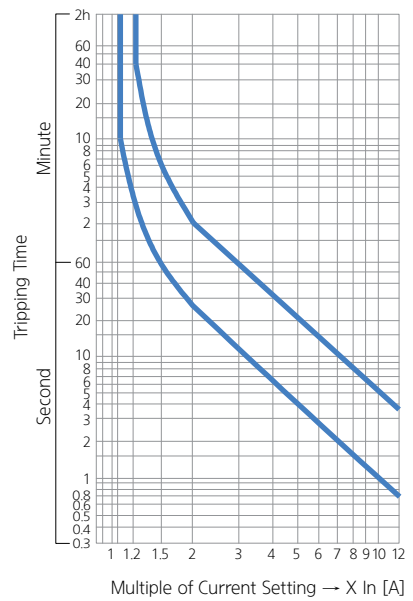

Technical Information

Cautions for Installing

- Please install the contactor in a place free from moisture and vibration.
- It is recommended to install the contactor in a vertical plane, but +30° slant is acceptable as standard installation.
- Lateral or horizontal installation could decrease the mechanical lifetime and electrical performance of contactor compared with standard installation.
- The contactor may get damaged by arc if the insulation distance stated in the below table is not followed.
- Ambient temperature (Standard) : -5°C ~ + 40°C

Regular Mounting

Vertical and Horizontal Mounting

Insulation Distance

(Unit: mm)

Distance	Model	Above HGC75				
		HGC75 - 100	HGC115 - 150	HGC185 - 265	HGC300 - 500	HGC630 - 800
L1		30	30	80	80	80
L2		5	15	15	15	20
L3		6	11	32	32	40

Precautions

⚠ Safety Precautions

- All procedures must be conducted only by qualified persons. Otherwise, electrical shock, personal injury, or a fire could occur.
- The product shall not be stored or operated in abnormal environment, such as, but not limited to, high temperature, high humidity, over vibration, dust, and corrosive gas.
- All care must be taken to prevent dust, moisture, and foreign objects from entering the product.

⚠ Transportation and Storage

- Do not open the package.
- Do not leave the products on the ground. Place it on a table or similar.
- Do not store in high temperature, high humidity, or corrosive gas areas.

⚠ Check Point Before Operation

- Do not operate before setting and adjustment.

⚠ Precautions for Installation, Operation, and Maintenance

- The product, bolt tightness, assembled status, and operating condition shall be checked visually and electrically from time to time. If any damage occurs, the product or parts must be replaced immediately.
- Rated current, rated voltage, load capacity, frequency, but not limited to, of the product must meet the load.
- Power must be OFF before wiring work.
- Supply voltage should be applied with right rating of the product. Otherwise, electrical shock, personal injury, or a fire could occur.
- Cable and terminal must be suitable for the product and the load.
- All wirings, especially for main terminal and coil terminal, shall be tightened by proper torque in correct manner.
- Routine check for the connection of circuit is needed.
- The function of product and contacts shall be checked occasionally and if defect is found, proper replacement is needed.
- Lubrication is prohibited on the product, parts, and wirings.
- Proper tool should be used for maintenance.

Contact Arrangement

Magnetic Contactor

Model	Contacts		Contact Arrangement	
	Main	Auxiliary	AC	DC
HGC9 HGC12 HGC18 HGC25 HGC32 HGC40	2NO + 2NC	-		Same as left
HGC50 HGC65 HGC75 HGC85 HGC100	2NO + 2NC	2NO + 2NC		Same as left
HGC115 HGC130 HGC150 HGC185 HGC225 HGC265 HGC300 HGC400 HGC500 HGC630 HGC800	2NO + 2NC	-		
	2NO + 2NC	2NO + 2NC		

Control Relay

Model	Contacts	Contact Arrangement
HGR04	4NC	
HGR13	1NO + 3NC	
HGR22	2NO + 2NC	
HGR31	3NO + 1NC	
HGR40	4NO	

Order Information

Magnetic Contactors



- 1 Model
- 2 Type Based on Rating
- 3 Auxilliary Contact Arrangement
- 4 Application
- 5 Terminal Type
- 6 Coil Voltage Type
- 7 Coil Voltage

2 Type Based on Rating		
Basic Magnetic Contactor		
Code	Rated Current	Rated Capacity
	AC3/AC400 V	
9	9 A	4 kW
12	12 A	5.5 kW
18	18 A	7.5 kW
25	25 A	11 kW
32	32 A	15 kW
40	40 A	18.5 kW
50	50 A	22 kW
65	65 A	30 kW
75	75 A	37 kW
85	85 A	45 kW
100	100 A	55 kW
115	115 A	60 kW
130	130 A	65 kW
150	150 A	75 kW
185	185 A	90 kW
225	225 A	132 kW
265	265 A	147 kW
300	300 A	160 kW
400	400 A	220 kW
500	500 A	250 kW
630	630 A	330 kW
800	800 A	440 kW

2 Type Based on Rating		
Capacitor Switching Contactor		
Code	Rated Current	Capacitor Capacity
		(AC440 V)
9C	9 A	9.7 kVAR
12C	12 A	12.5 kVAR
18C	18 A	16.7 kVAR
25C	25 A	18 kVAR
32C	32 A	30 kVAR
40C	40 A	33.3 kVAR
50C	50 A	4 5kVAR
65C	65 A	46 kVAR
75C	75 A	54 kVAR
85C	85 A	60 kVAR
100C	100 A	80 kVAR

3 Auxilliary Contact Arrangement	
Standard Magnetic Contactor	
11	1NO + 1NC
21	2NO + 1NC
22	2NO + 2NC
Capacitor Switching Contactor	
23	2NO + 3NC
32	3NO + 2NC
4 Application	
N	Normal
5 Terminal Type	
Standard Magnetic Contactor	
R	No Terminal Cover
S	Terminal Cover (9 - 100 A)
C	Lug terminal (50 - 100 A)
Capacitor Switching Contactor	
S	Terminal Cover

6 Coil Voltage Type	
Standard Magnetic Contactor	
X	AC 50Hz (9 - 100 A)
A	AC 60Hz (9 - 100 A)
D	DC (9 - 100 A)
F	AC/DC
Capacitor Switching	
X	AC 50 Hz
A	AC 60 Hz
7 Coil Voltage	
24 - 440 V	

※ When ordering, please refer to each type's page for details.

Thermal Overload Relays

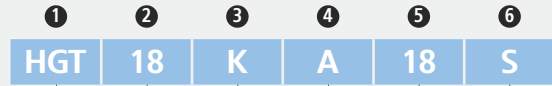

- 1 Model
- 2 Applicable Contactor Rating
- 3 Number of Terminal
- 4 Characteristics Class (Feature Curve)
- 5 Setting Current
- 6 Terminal Type

2 Applicable Contactor Rating

Code	Applicable Contactor
18	HGC9 - 18
40	HGC25 - 40
65	HGC50, 65
100	HGC75 - 100
150	HGC115 - 150
265	HGC185 - 265
500	HGC300 - 500
800	HGC630 - 800

3 Number of Terminal

K	3 elements
H	2 elements

4 Characteristics Class (Feature Curve)

A	10 A
B	10
C	20

※ When ordering, please refer to each type's page for details.

5 Setting Current

Code	Setting Current
OP18	0.12 - 0.18 A
OP26	0.18 - 0.26 A
OP35	0.25 - 0.35 A
OP50	0.34 - 0.5 A
OP70	0.5 - 0.7 A
OP90	0.6 - 0.9 A
1P20	0.8 - 1.2 A
1P60	1.1 - 1.6 A
2P10	1.5 - 2.1 A
3	2 - 3 A
4P20	2.8 - 4.2 A
5	3 - 5 A
6	4 - 6 A
8	5.6 - 8 A
9	6 - 9 A
10	7 - 10 A
12	8 - 12 A
18	12 - 18 A
22	15 - 22 A
25	17 - 25 A

5 Setting Current

Code	Setting Current
32	22 - 32 A
40	28 - 40 A
50	34 - 50 A
65	45 - 65 A
75	52 - 75 A
80	48 - 80 A
85	59 - 85 A
100	70 - 100 A
115	69 - 115 A
130	78 - 130 A
150	90 - 150 A
185	111 - 185 A
225	135 - 225 A
265	159 - 265 A
300	180 - 300 A
400	240 - 400 A
500	300 - 500 A
630	378 - 630 A
800	480 - 800 A

6 Terminal Type

R	No Terminal Cover
S	Terminal Cover
C	Lug Terminal (50 - 100 A)

Order Information

Auxiliary Relay

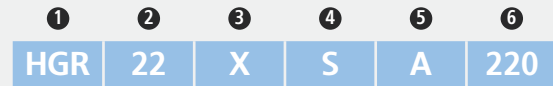

- 1 Model
- 2 Auxilliary Contact Arrangement
- 3 Control Type
- 4 Terminal Type
- 5 Coil Voltage Type
- 6 Coil Voltage

2 Auxiliary Contact Arrangement	
04	4NC
13	1NO + 3NC
22	2NO + 2NC
31	3NO + 1NC
40	4NO

3 Control Type	
X	AC
P	DC (Permanent Magnet)

4 Terminal Type	
R	No Terminal Cover
S	Terminal Cover

5 Coil Voltage Type	
X	AC 50 Hz
A	AC 60 Hz
D	DC

6 Coil Voltage	
24 - 440 V	

Accessories



- 1 Model
- 2 Accessories
- 3 Rating

2 Accessories	
TB	Auxiliary Contact Block (Front)
SB	Auxiliary Contact Block (Side)
IU	Mechanical Interlock Block
LB	Mechanical Latching Block
RC	Surge Absorber
CD	Clamping Diode
ET	Timer
CU	Capacitor Switching Unit

3 Rating: Please refer to each accessories' page for details.

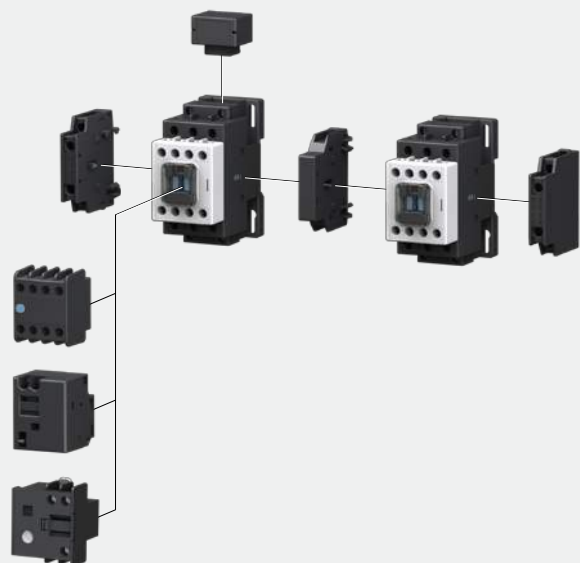

Dimensions

Magnetic Contactor

(Unit: mm)

HGC9 / HGC12 / HGC18

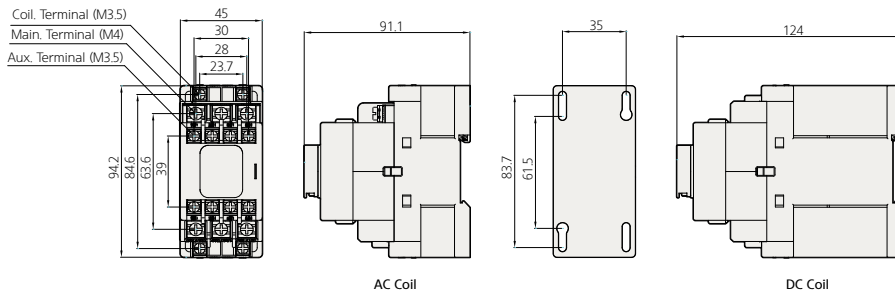

Accessories	A (mm)
Aux. Contact HGCTB	35
Latching Block HGCLB	42.5
Timer HGCET	39

※ () is for DC.

HGC25 / HGC32 / HGC40

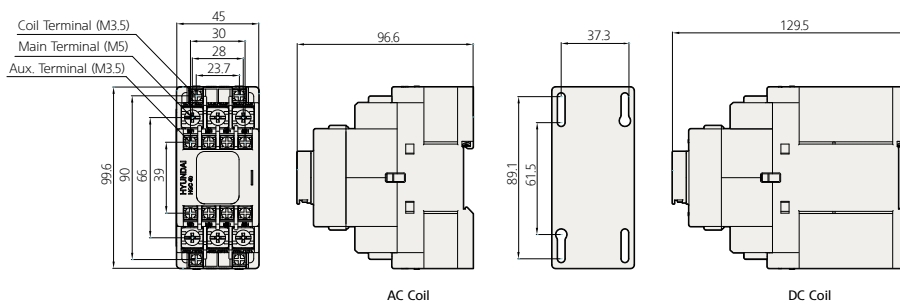

Accessories	A (mm)
Aux. Contact HGCTB	35
Latching Block HGCLB	42.5
Timer HGCET	39

※ () is for DC.

HGC50 / HGC65 (AC/DC)

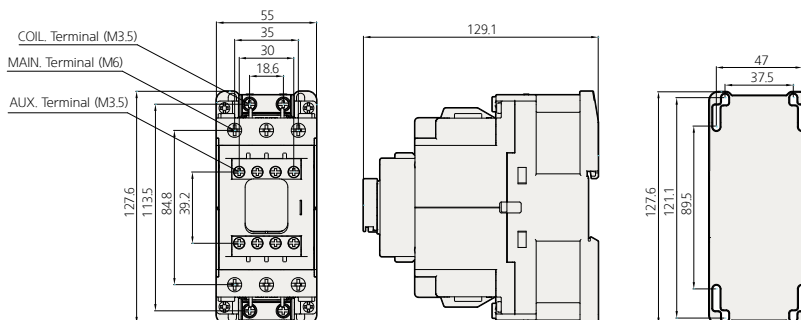

Accessories	A (mm)
Aux. Contact HGCTB	35
Latching Block HGCLB	42.5
Timer HGCET	39

※ () is for DC.

Dimensions

Magnetic Contactor

(Unit: mm)

HGC75 / HGC85 / HGC100 (AC/DC)

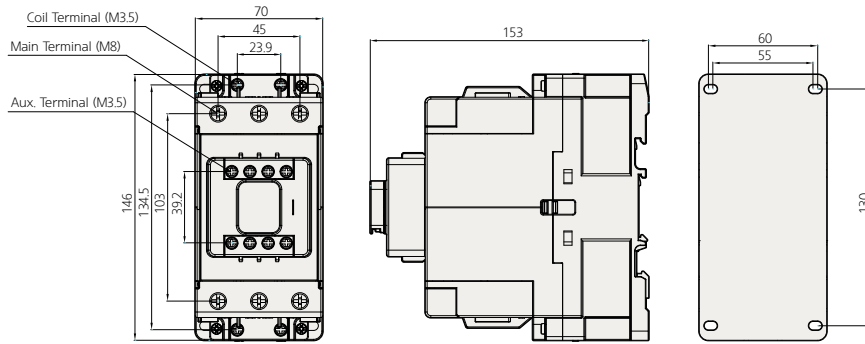

Accessories	A (mm)
Aux. Contact HGCTB	35
Latching Block HGCLB	42.5
Timer HGCET	39

※ () is for DC.

HGC115 / HGC130 / HGC150

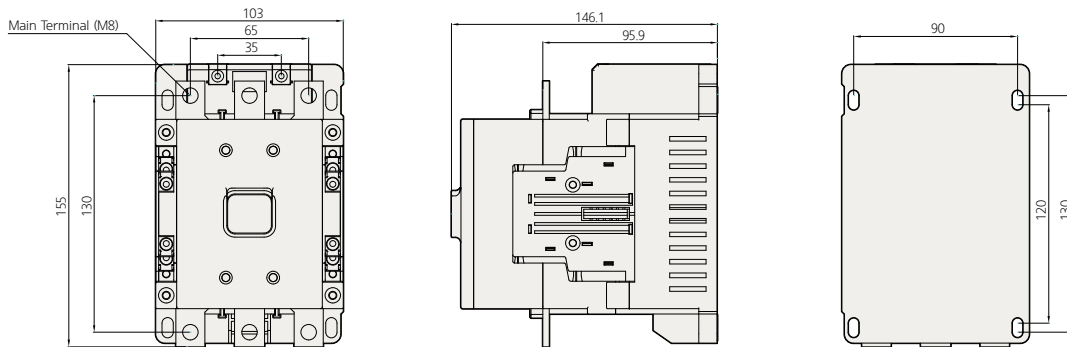

HGC185 / HGC225 / HGC265

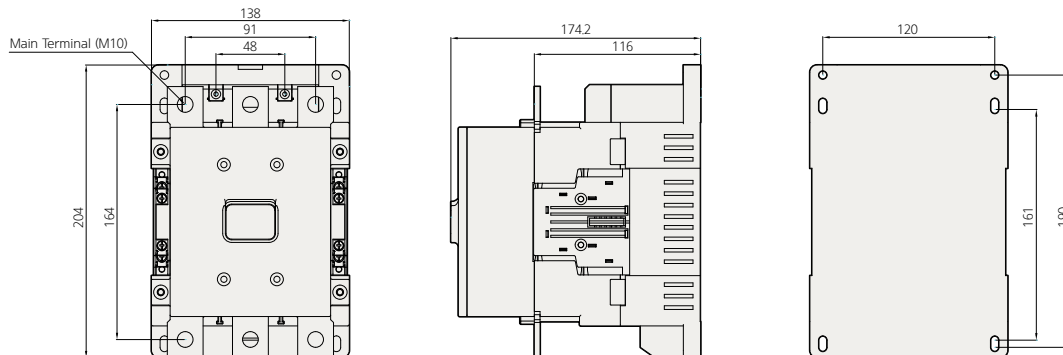

Magnetic Contactor

(Unit: mm)

HGC300 / HGC400 / HGC500

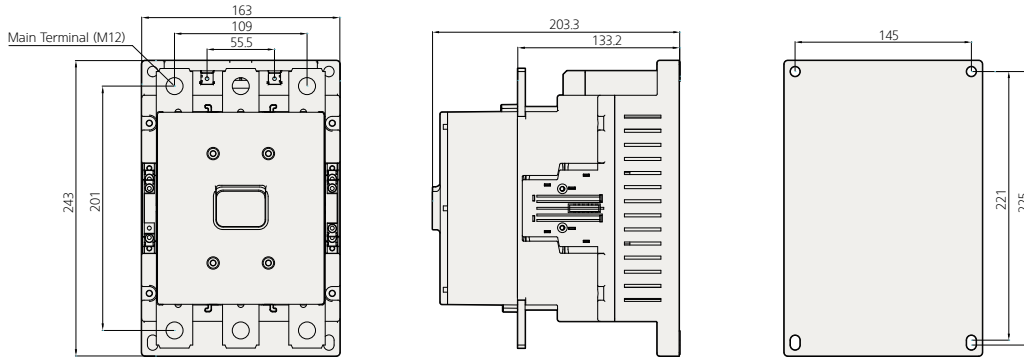

HGC630 / HGC800

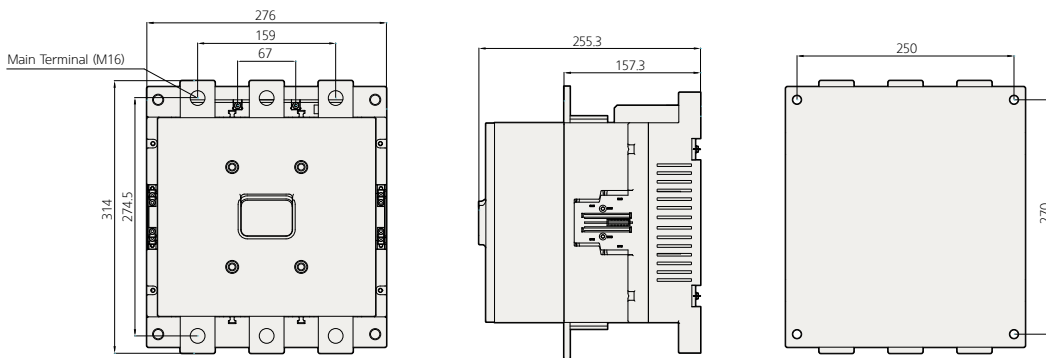

Control Relay

(Unit: mm)

HGR (AC)

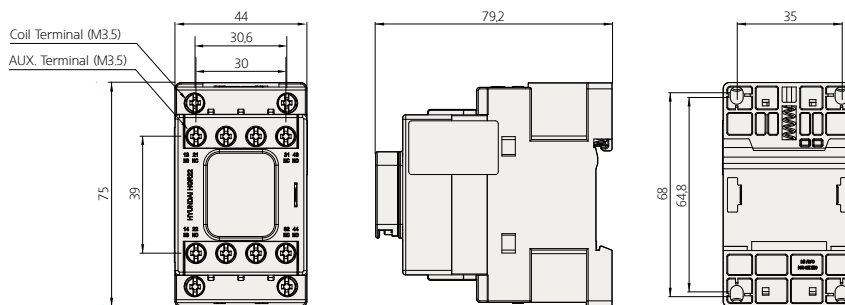

Accessories	A (mm)
Aux. Contact HGCTB	35
Latching Block HGCLB	42.5
Timer HGCET	39

※ () is for DC.

Dimensions

Control Relay

(Unit: mm)

HGR (DC)

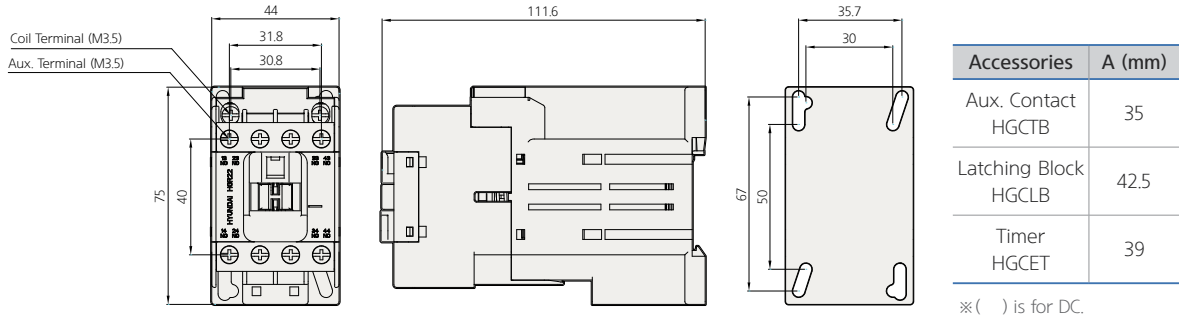

HGR-P (Permanent Magnet)

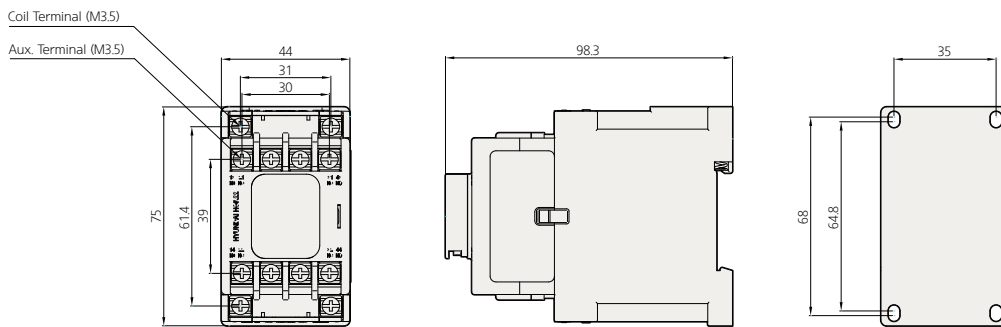

Magnetic Switch (Magnetic Contactor + TOR)

(Unit: mm)

HGC9 / HGC12 / HGC18 + HGT18

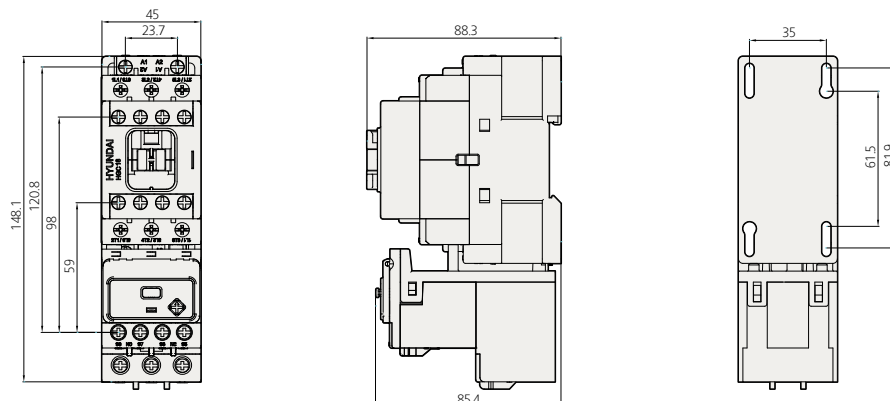

Magnetic Switch (Magnetic Contactor + TOR)

(Unit: mm)

HGC25 / HGC32 / HGC40 + HGT40

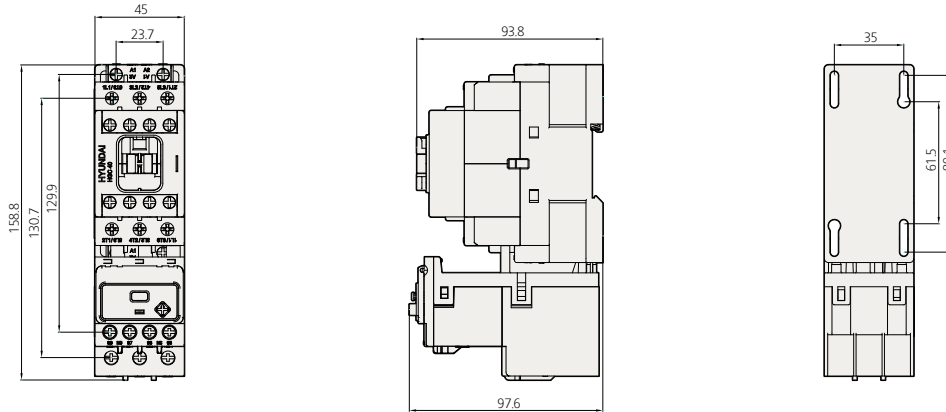

HGC50 / HGC65 + HGT65

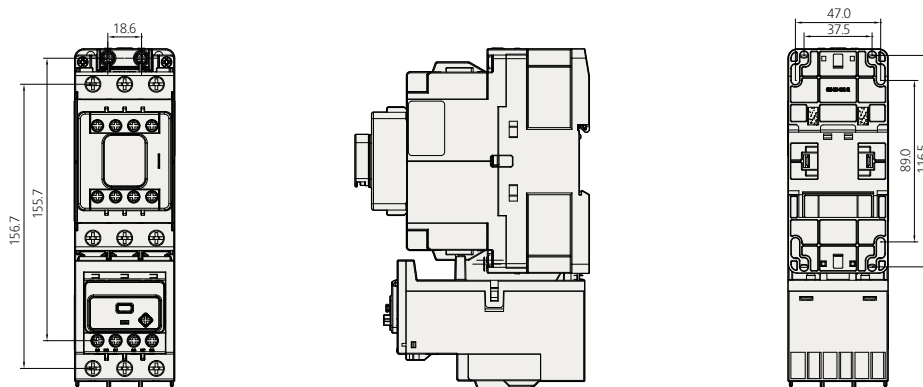

HGC75 / HGC85 / HGC100 + HGT100

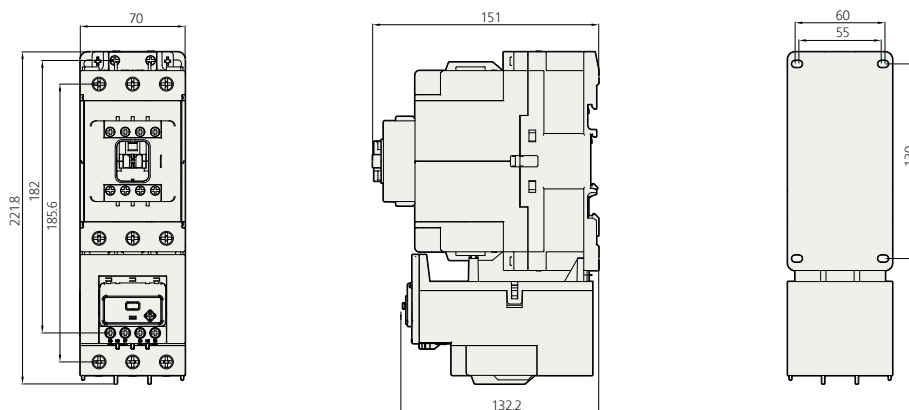

Dimensions

Magnetic Switch (Magnetic Contactor + TOR)

(Unit: mm)

HGC115 / HGC130 / HGC150 + HGT150

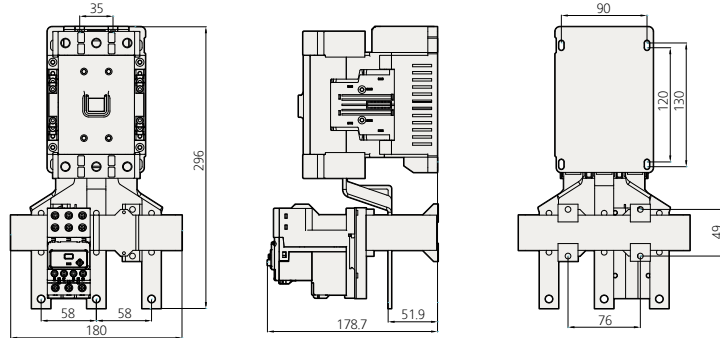

HGC185 / HGC225 / HGC265 + HGT265

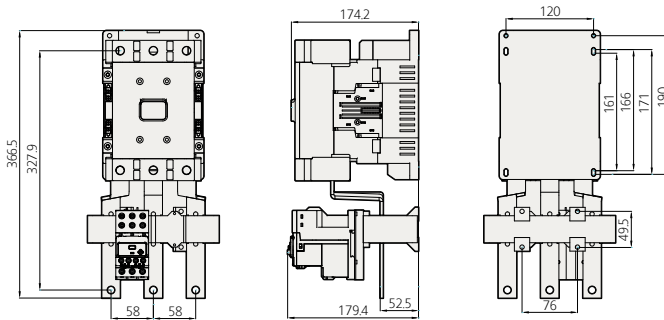

HGC300 / HGC400 / HGC500 + HGT500

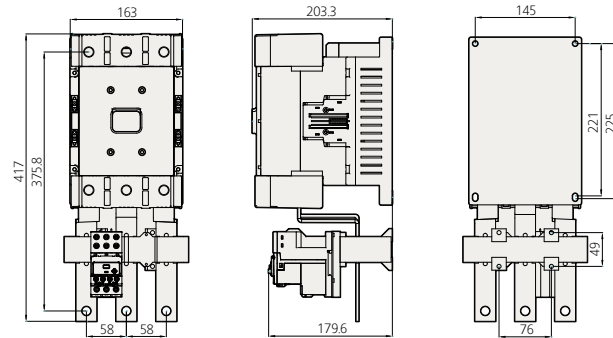

HGC630 / HGC800 + HGT800 (630, 800 A)

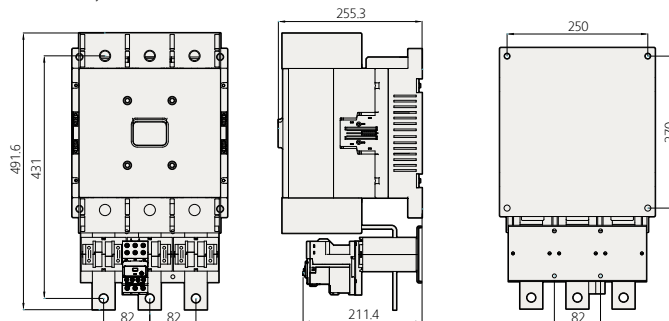

Thermal Overload Relay

(Unit: mm)

HGT18

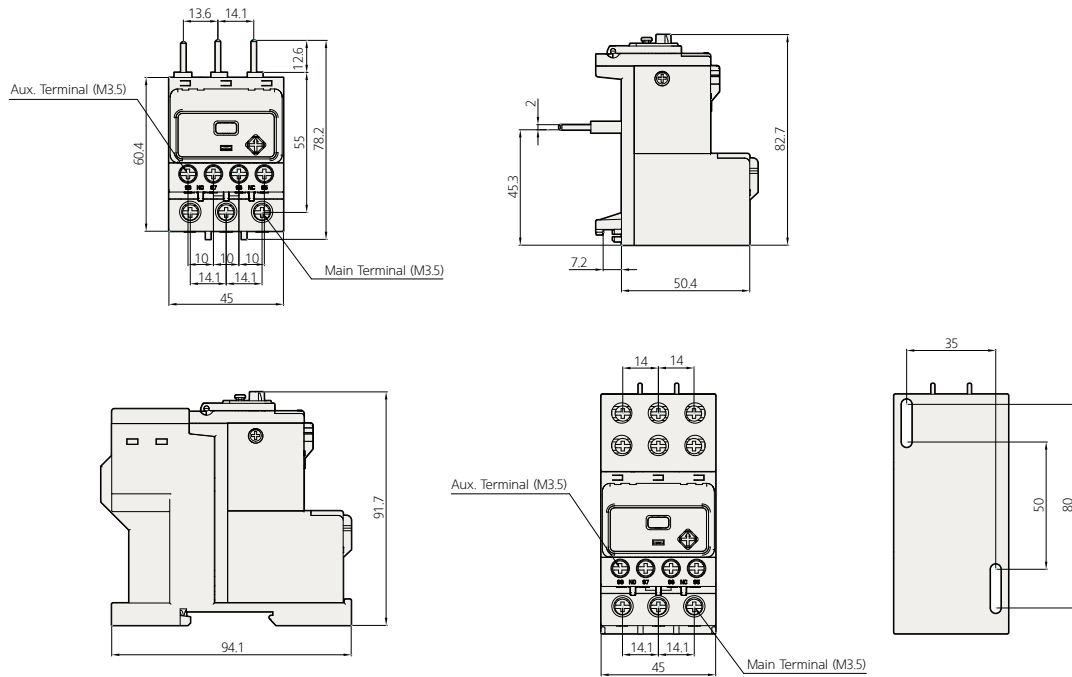

HGT40

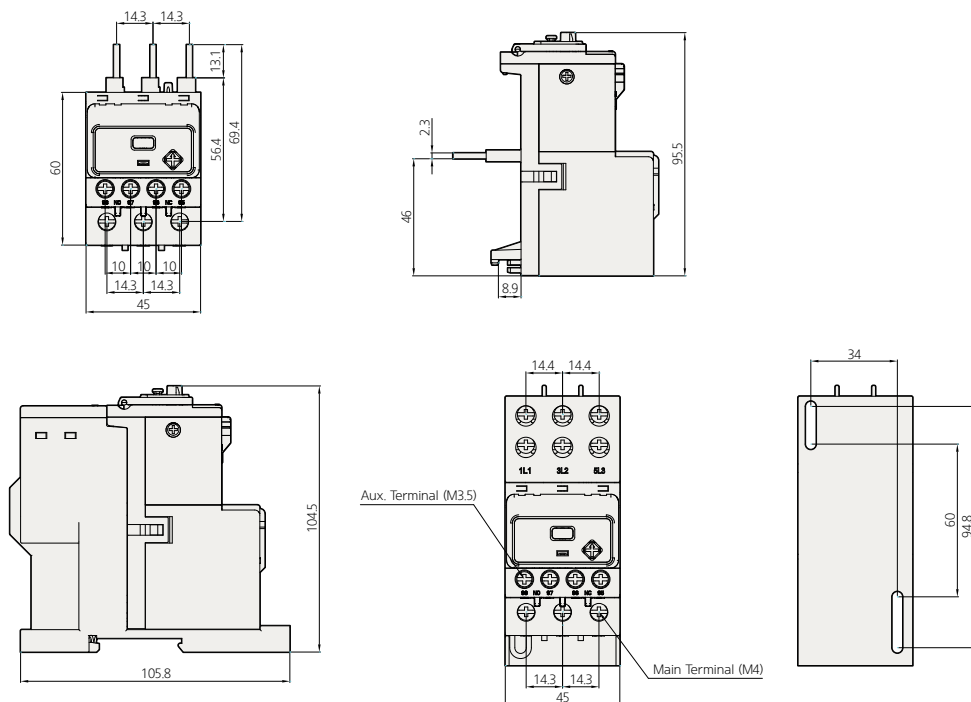

Dimensions

Thermal Overload Relay

(Unit: mm)

HGT65

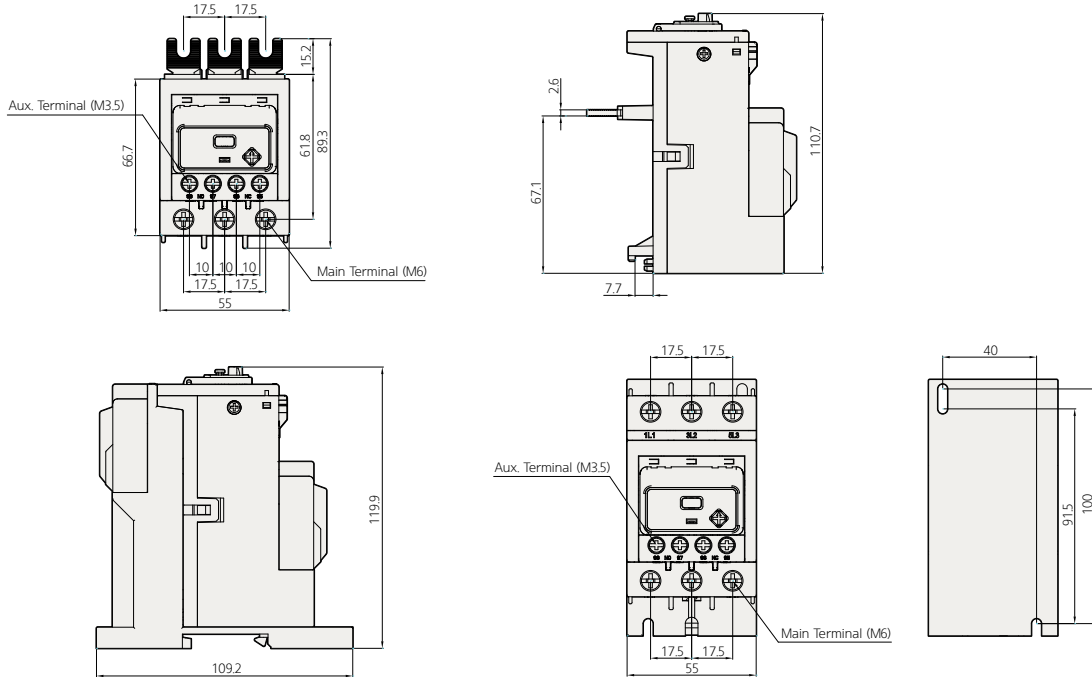

HGT100

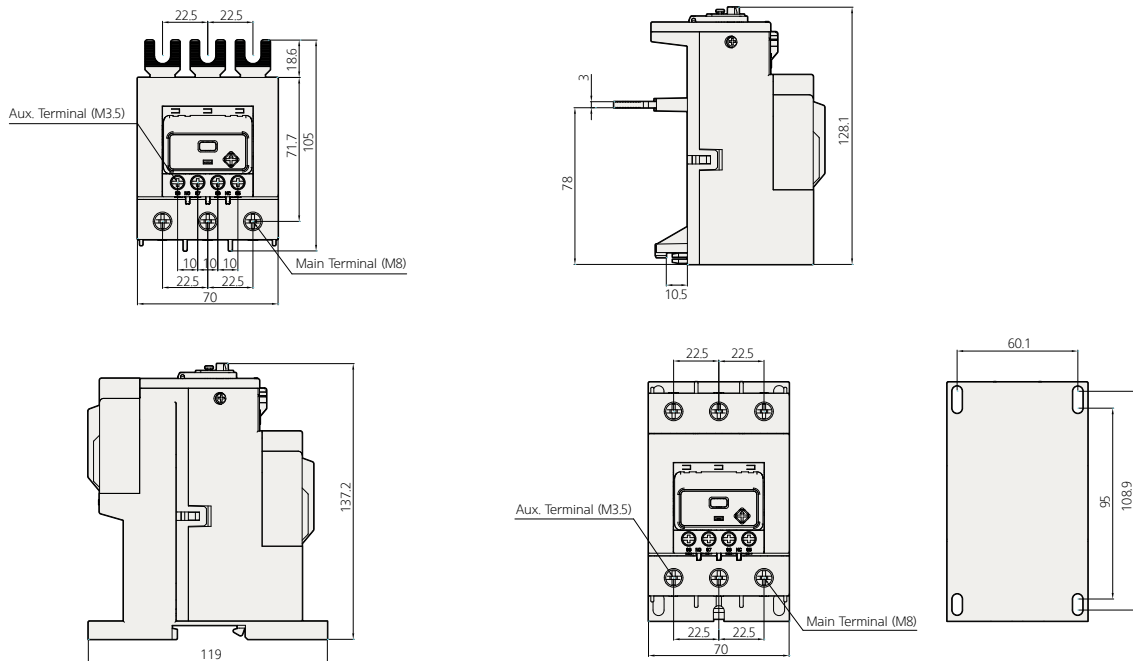

(Unit: mm)

HGT150

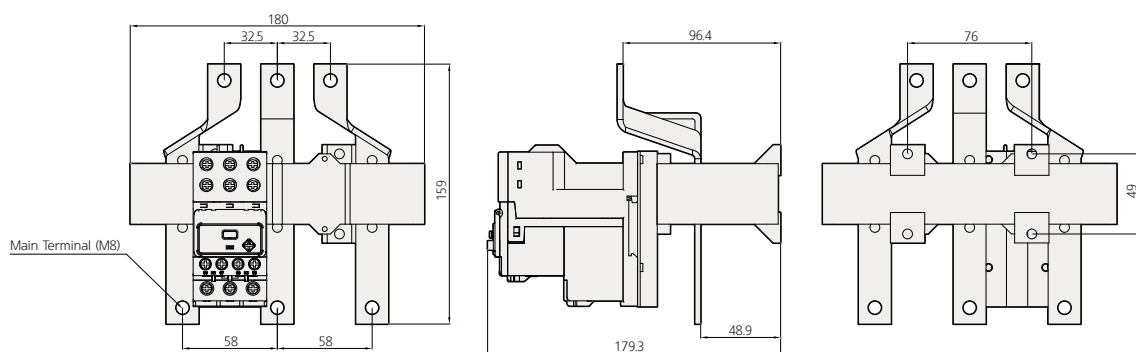

HGT265

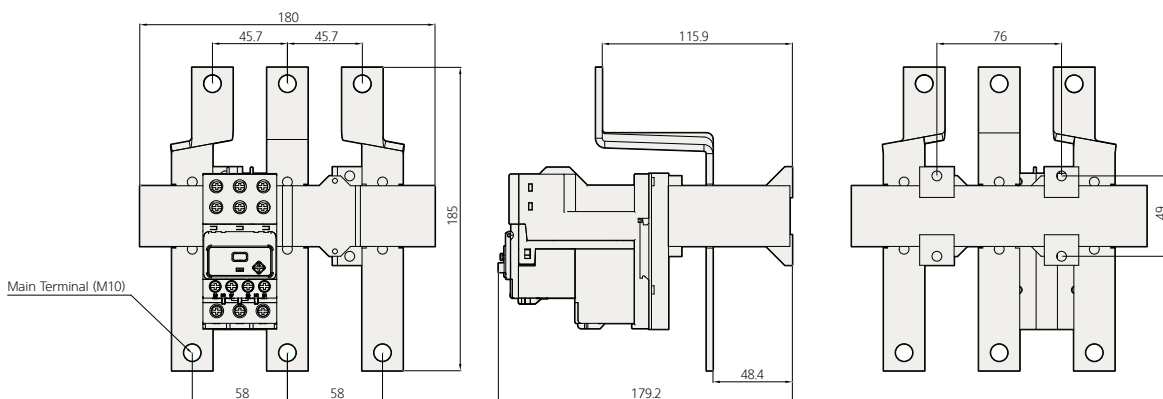

Dimensions

Thermal Overload Relay

(Unit: mm)

HGT500

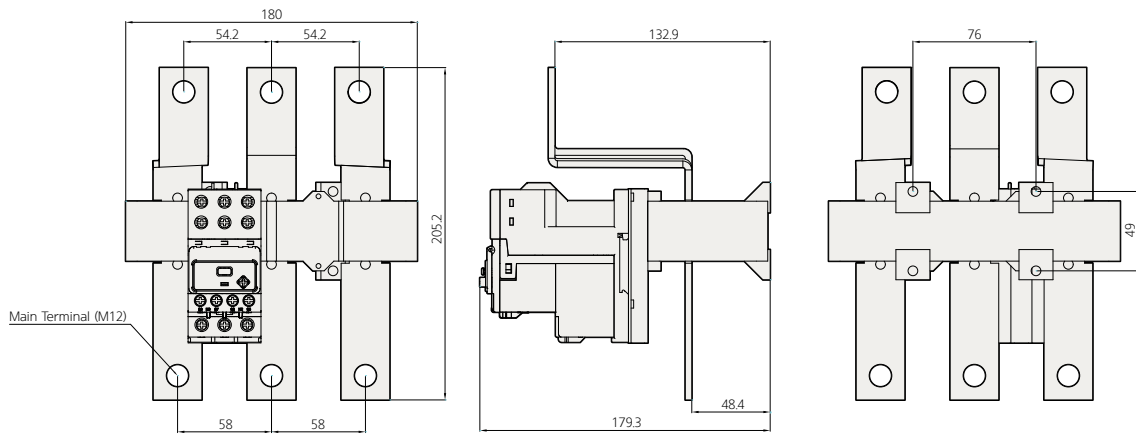

HGT800

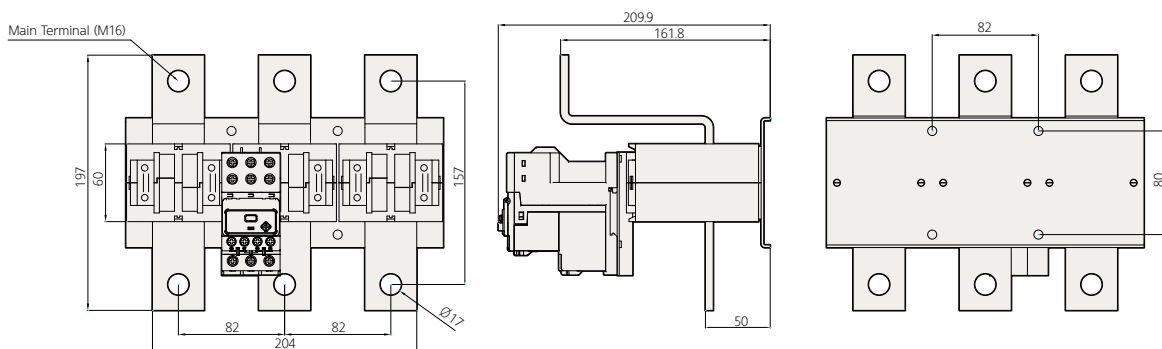

Magnetic Contactor + Capacitor Switching Unit

(Unit: mm)

HGC18C

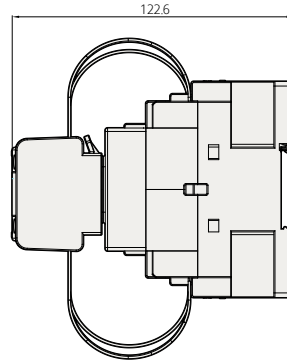
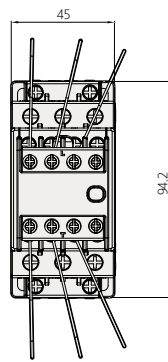

HGC40C

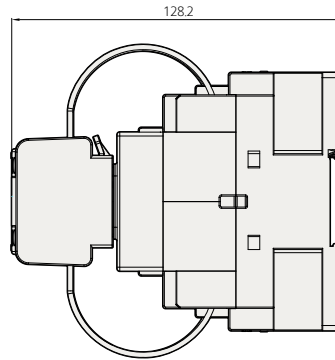
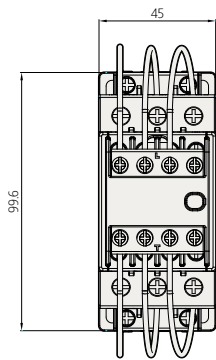

HGC65C

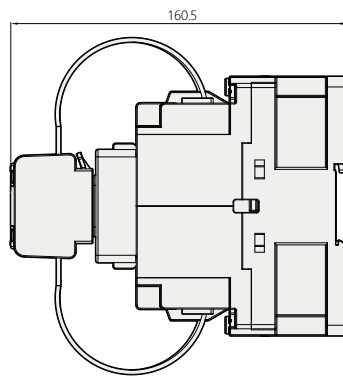
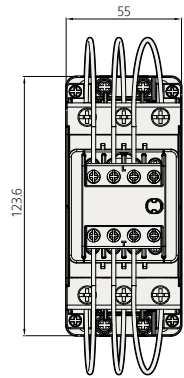

HGC100C

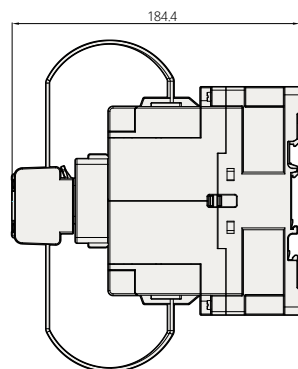
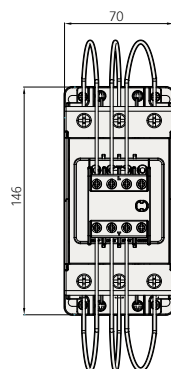

Dimensions

Reversing Contactor (With Interlock Unit)

(Unit: mm)

HGC18R

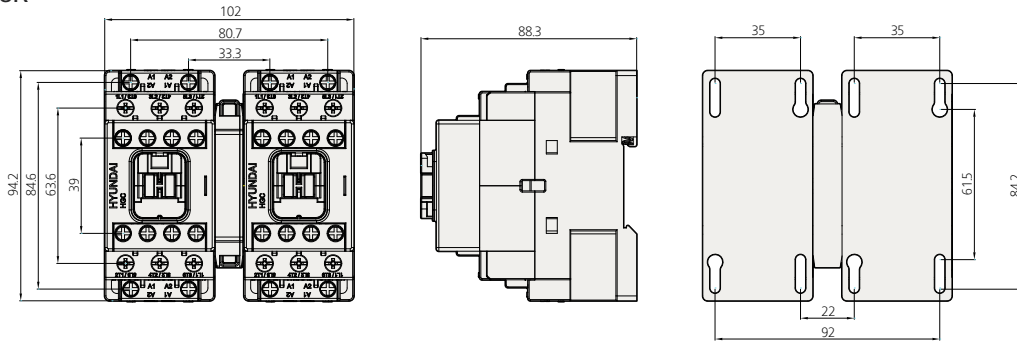

HGC40R

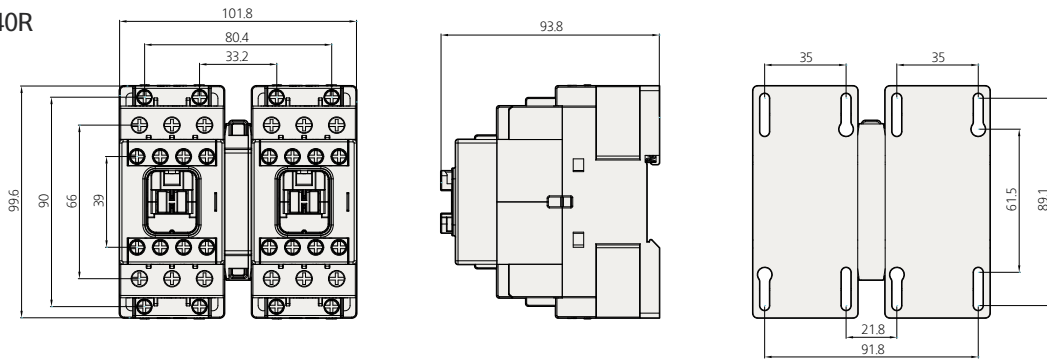

HGC65R

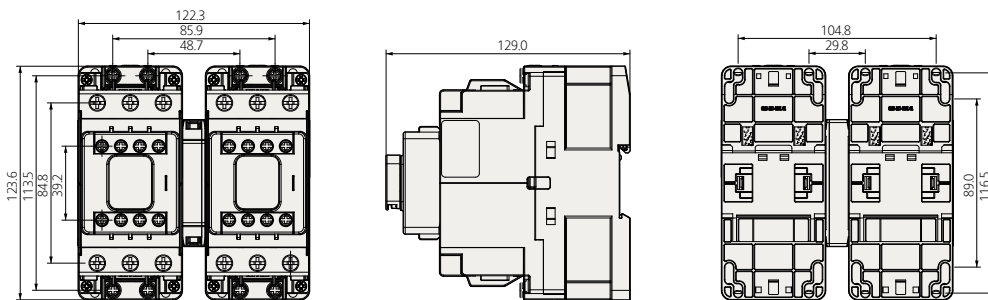

HGC100R

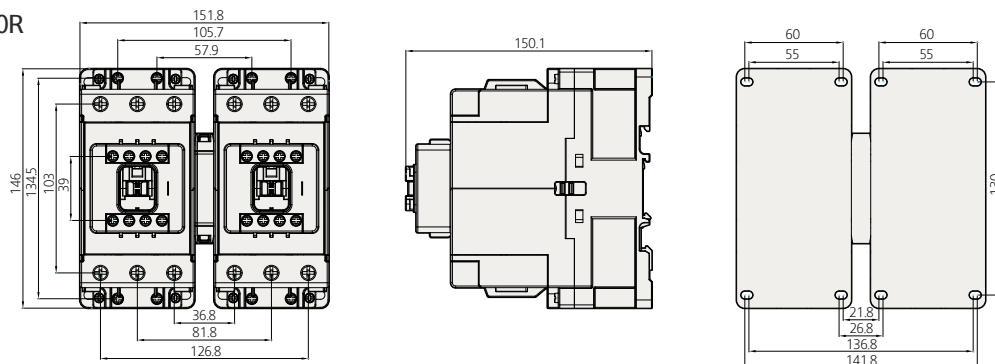

Reversing Contactor (With Interlock Unit)

(Unit: mm)

HGC150R

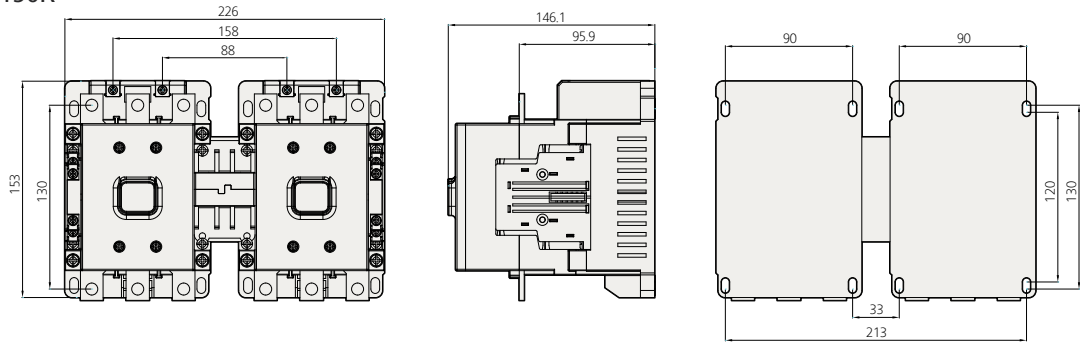

HGC265R

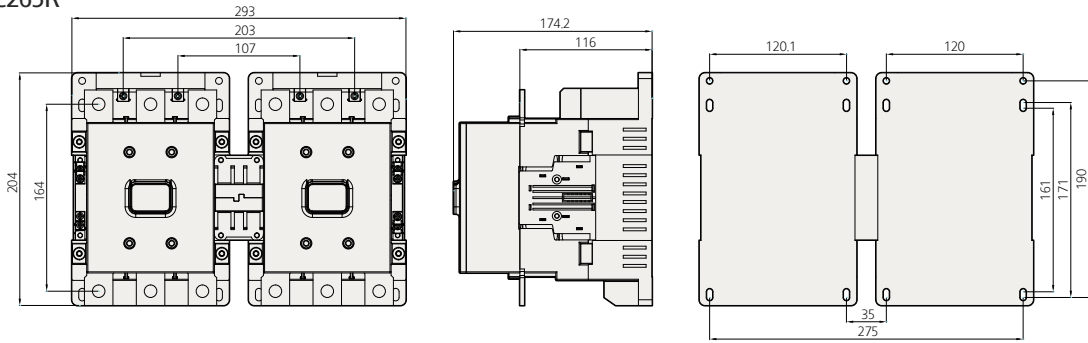

HGC500R

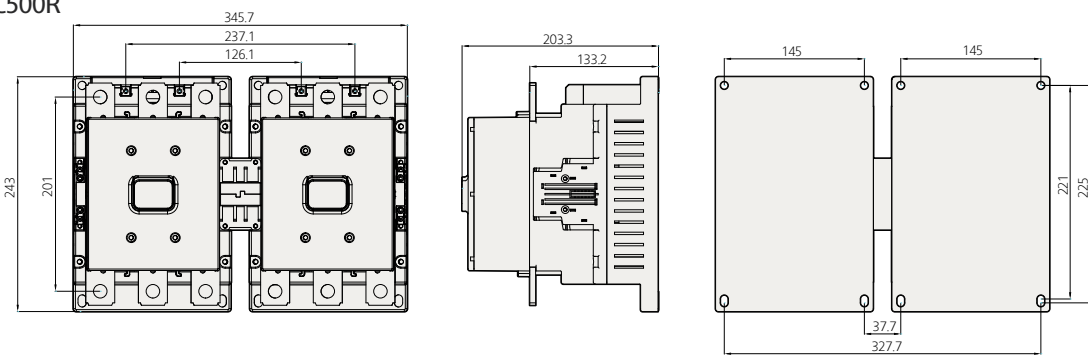

HGC800R

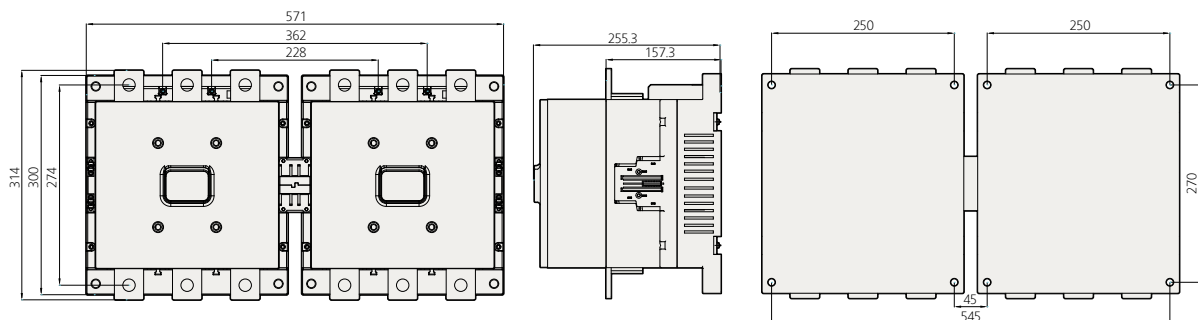



www.hyundai-elec.com

HYUNDAI | **ELECTRO ELECTRIC SYSTEMS**
HEAVY INDUSTRIES

Head Office	1000, Bangeojinsunhwan-doro, Dong-gu, Ulsan, Korea Tel: 82-52-202-8101~7 Fax: 82-52-202-8100
Seoul (Sales & Marketing)	75, Yulgok-ro, Jongno-gu, Seoul, Korea Tel: 82-2-746-7866, 7527, 4691 Fax: 82-2-746-7441
Atlanta	6100 Atlantic Boulevard, Norcross, GA 30071, USA Tel: 1-678-823-7839 Fax: 1-678-823-7553
London	2nd Floor, The Triangle, 5-17 Hammersmith Grove London, W6 0LG, UK Tel: 44-20-8600-7127 Fax: 44-20-8741-5620
Moscow	World Trade Center, Ent. 3# 703, Krasnopresnenskaya Nab. 12, Moscow, 123610, Russia Tel: 7-495-258-1381 Fax: 7-495-258-1382
Mexico City	Bldv. Manuel Avila Camacho 40, Torre Esmeralda 1, Piso 16, Col. Lomas de Chapultepec, Del. Miguel Hidalgo, Mexico D.F. 11000, Mexico Tel: 52-55-2623-7048
Tokyo	8th Floor, North Tower Yurakucho Denki Bldg., 1-7-1 Yuraku-cho, Chiyoda-ku, Tokyo 100-0006, Japan Tel: 81-3-3211-4792 Fax: 81-3-3216-0728
Osaka	I-Room 5th Floor Nagahori Plaza Bldg. 2-4-8 Minami Senba, Chuo-ku, Osaka, 542-0081, Japan Tel: 81-6-6261-5766~7 Fax: 81-6-6261-5818
Riyadh	Office No. 230, 2nd Floor, 4th Akariya Plaza, Olaya Street, PO Box 8072, Riyadh 11485, Saudi Arabia Tel: 966-11-464-4696 Fax: 966-11-462-2352
Al Khobar	7th Floor, Al Khobar Business Gate Building PO Box 20753, Al Khobar-31952, Kingdom of Saudi Arabia Tel: 966-013-849-3876~7
Dubai	Unit 205, Building 4, Emaar Square, Sheikh Zayed Road, Pobox 252458, Dubai, UAE Tel: 971-4-425-7995 Fax: 971-4-425-7996
Sofia	1271 Sofia 41, Rojen Blvd., Bulgaria Tel: 359-2-803-3200, 3220 Fax: 359-2-803-3203
Alabama	215 Folmar Parkway, Montgomery, AL 36105, USA Tel: 1-334-481-2000 Fax: 1-334-481-2098
Vladivostok	15 str. Potemkina, Artem, Primorskiy Krai, 692760, Russia Tel: 7-423-201-0110 Fax: 7-423-201-0110
Yangzhong	No.9 Xiandai Road, Xinba Scientific and Technologic Zone, Yangzhong, Jiangsu, P.R.C. Zip: 212212, China Tel: 86-511-8842-0666, 0500 Fax: 86-511-8842-0668, 0231